

# Section B - Casings

## McCOY MILLWORK

Custom Shop Services

For custom profiles pricing is determined by the chosen species of wood and quantity. Provide the following:

1. A sample or scale drawing of the profile.
2. Amount of moulding needed in Lineal Feet.
3. Preferred species of wood.
4. Preferred final finish (paint or stain).

Send us your information via email or come in for a quote. You can expect to hear from us regarding pricing in 2 days.

Manufacturing time varies: 2 days-2 weeks.

Profile #	Pg #	Profile #	Pg #	Profile #	Pg #	Profile #	Pg #
001-T2 Fluted Casing	66	121-T2 Casing	52	172-T2 Casing	53	355 T2 Casing	54
010-T2* Fluted Casing	66	122-T2 Casing	55	173B-T2 Casing	39	356 T2* Casing	56
011-T2 Fluted Casing	66	130-T2* Casing	58	173-T2 Casing	39	357 T2 Casing	57
012-T2 Fluted Casing	66	133-T2 Casing	58	174B-T2 Casing	52	358 T2 Casing	57
013-T2 Fluted Casing	66	134-T2* Casing	52	174-T2 Casing	39	359 T2 Casing	55
014-T2 Fluted Casing	66	137-T2 Casing	57	175-T2 Casing	54	384 BV Apron	71
015-T2 Fluted Casing	66	138-T4 Casing	45	176-T2 Casing	51	386 T3 Casing	46
021-T2 Reeded Casing	65	139-T2 Casing	54	177-T3 Casing	48	387 MV Casing	53
022-T2 Casing	54	140-T2* Casing	42	178-T3 Symm Casing	63	387 T2 Casing	52
023-T4 Sym Casing	60	141-T2 Casing	42, 56	179-T3 Sym Casing	62	388b T2 Casing	56
024-T4 Sym Casing	61	142-T2 Casing	57	180-T4* Sym Casing	61	388c T2 Casing	56
025-T2 Reeded Casing	65	143-T2 Casing	42	181B-T4 Casing	60	388d T2 Casing	56
026-T1 Reeded Casing	65	144-T2 Casing	57	181-D4 Sym Casing	61	388 T2 Casing	57
027-T2 Reeded Casing	65	145-T3 Casing	51	181-T4 Sym Casing	61	390 T2 Casing	50
028-T2 Sym Casing	65	148-T2 Casing	48	183-T3 Sym Casing	62	391 T1 Casing	57
029-T2 Symmetrical Casing	64	149B-T2 Casing	52	185B-T2 Sym Casing	55	392.2 T2 Step Casing	52, 53
030-T2 Fluted Casing	66	149-T2 Casing	51	185-T2* Casing	52	392 T2 Step Casing	52
031-T3 Symm Casing	63	150B-T2 Casing	41	187-D2 Symm Casing	64	409 S1 Stop	76
100-T1* Sym Casing	64	150-T2* Casing	42	191-T2 Casing	56	410 T2 Casing	56
107-T1 Casing	58	151-T3 Casing	45	193-T2 Casing	56	411 T2* Casing	54
108-T1 Casing	58	152-T3 Casing	45	194-T2 Casing	56	413 T2 Casing	53
109-T1 Casing	58	153-M2 Apron	71	196-T2 Casing	55	415 S1 Stop	76
110-T1* Casing	58	153-T3 Casing	45	207-T3 Apron/Casing	73	416 T3 Casing	45
111B-T2 Casing	39	155-T3* Casing	47	248-P2 Casing	57	417 S1* Stop	76
111-T2* Casing	40	156-T2 Casing	41	261-T1 Clamshell Casing	59	419 S1 Stop	76
112-T1* Casing	57	158-T2 Casing	49	262 T1* Clamshell Casing	59	420 S1* Stop	76
113B-T3 Casing	48	158-T3 Casing	44	263 T1 Clamshell Casing	59	422 S1 Stop	76
113-T2* Casing	53	158-T4 Casing	44	263 T2 Clamshell Casing	59	423 S1 Stop	76
114-BV Casing	43	159B-T3 Casing	41	264b T2 Casing	56	424 P2 Misc/Apron	71
115-T2* Casing	56	159-T3 Casing	41	264 T2 Casing	54	424 S1 Stop	76
116-T2 Casing	50	162-B2 Casing	57	265 T2* Clamshell Casing	59	427 P2 Apron	71
117-T2 Casing	54	170B-T2 Casing	55	266 T2 Casing	54	436 P1 Apron	71
118-T2 Casing	54	170C-T2 Casing	55	268 T2 Clamshell Casing	59	444 T2* Casing	53
119-T3 Casing	47	170-T2 Casing	56	269 M2 Apron	71	447 T2 Casing	52
120-M4 Apron	73	171B-T2 Casing	40	304 A2 Backband	77	448 T2 Casing	51
120-T2 Casing	53	171-T2 Casing	40	319 M1 Apron	73	487 T2 Casing	53



Profile #	Pg #	Profile #	Pg #	Profile #	Pg #	Profile #	Pg #
488 T2 Casing	52	906 L2 Lintel	68	1114 T3 Casing	48	1175 T2 Casing	40
496 T3 Casing	45	907 L2 Lintel	67	1117 T2 Reeded Casing	65	1176 T2 Casing	39
503 S1* Parting Bead	70	908 L2 Lintel	68	1118 T2 Casing	42	1177 T2 Casing	39
504 L2* Lintel	67	909 L2 Lintel	68	1120 T2 Casing	57	1181 T4 Sym Casing	60
525-T4 Symm Casing	61	909 M1 Apron	72	1121 T2 Casing	53	1182 T4 Sym Casing	61
528 PV Apron	71	910 L2* Lintel	67	1122 T2 Casing	53	1183B-T4 Sym Casing	60
529 T2 Sym Casing	64	911 L2* Lintel	67	1123 A1 Backband	77	1183 T3 Sym Casing	62
530 T2 Symm Casing	64	912 L2* Lintel	67	1123-T2 Casing	53	1183 T4 Sym Casing	62
533 T2 Casing	41	913 L2 Lintel	70	1124 T2 Casing	50	1184 T3 Sym Casing	63
534 T2 Casing	53	914 L2 Lintel	69	1125 A1 Backband	77	1188 T4 Sym Casing	60
534-T3 Casing	46	915 L3 Lintel	70	1126 A1 Backband	77	1193 T2 Casing	55
535 T2* Casing	51	916 L2 Lintel	69	1127 A1 Backband	77	1203 T2 Casing	57
536 T3 Casing	46	917 L2 Lintel	68	1128 A1 Backband	77	1211 T4 Casing	43
547 L2 Lintel	69	919 L2 Lintel	67	1129 A1 Backband	77	1212 T4 Casing	43
620 T2 Casing	55	921 L2 Lintel	69	1130 T2 Casing	58	1213 T3 Casing	46
717 D2 Apron	73	922 L2 Lintel	69	1131 T1 Casing	58	1214 T4 Casing	43
726 P2 Apron	71	929 L2 Lintel	69	1132 T2 Sanitary Casing	58	1261 T1 Clamshell Casing	59
746 P2 Apron	73	930 L2 Lintel	68	1133 T2 San Casing	58	1262 T1 Clamshell Casing	59
750 T2 Casing	53	931 M2 Apron	71	1136-A1 Backband	76	1264 T2 Clamshell Casing	59
751 MV Apron	71	944-T2 Casing	51	1137 T4 Casing	41	1266 T2 Casing	56
753 D4 Architrave	74	948 S1 Bead	70	1138 T3 Casing	45	1316 T3 Casing	46
755 T2 Casing	54	949 S1 Bead	70	1139B-TV Casing	50	1318 A2 Backband	76
756 T2 Casing	48	950 S1* Parting Bead	70	1139 T2 Casing	49	1318B-A2 Backband	76
757 T4 Casing	43	953B-S1 Parting Bead	70	1139 T3 Casing	44	1319 M1 Apron	73
770 M3 Apron	73	953 S1 Bead	70	1140 T2 Casing	42	1381 T3 Casing	48
772 M4 Apron	73	954 M1 Bead	70	1141 T2 Casing	57	1384-T2 Casing	54
781 P2 Casing	55	955 S1* Parting Bead	70	1142 T2 Casing	55	1438 T2 Colonial Casing	51
782 A1 Backband	76	956 S1 Parting Bead	70	1143 T2 Casing	55	1439 T2 Colonial Casing	50
803 T2 Symm Casing	64	984 A1 Backband	77	1145 T2 Casing	54	1444 T3 Casing	46
804 T3 Sym Casing	63	985 A1 Backband	77	1146 T2 Casing	55	1460 T2 Casing	56
806 T2 Casing	54	990 A1 Backband	77	1148 T2 Casing	54	1461 T2 Casing	52
807 P2 Apron	71	1001 T4 Fluted Casing	66	1149 T2 Casing	55	1462 T2 Casing	52
808 T2 Casing	57	1020 A1 Backband	77	1150 T2 Casing	41	1463 T2 Casing	51
821 T2 Casing	49	1021 A1* Backband	77	1151 T2 Casing	41	1464 T2 Apron/Misc	71
885 MV Sill	75	1022 A1* Backband	77	1152 T2 Casing	50	1467 T2 Casing	52
886 MV Sill	75	1024 A1 Backband	77	1153 T2 Casing	49	1504 L2 Lintel	67
887 MV Sill	75	1025 A1* Backband	77	1154 T2 Casing	49	1507 L2 Lintel	67
888 MV* Sill	75	1026 A1 Backband	76	1156 T2 Casing	51	1509 L2 Lintel	67
889 MV Sill	75	1027 A1 Backband	77	1157 T2 Casing	50	1521 T2 Sym Casing	66
894 D2 Sym Casing	64	1028 P2 Backband	77	1158 T2 Casing	49	1523 T2 Sym Casing	64
899 L2 Lintel	69	1029 A1* Backband	77	1159 T2 Casing	50	1524-T2 Reeded Casing	65
900 L2 Lintel	70	1039 T2 Casing	57	1170 T2 Casing	40	1526 T2 Symm Casing	64
901 L2 Backband	76	1104 T2 Casing	56	1171 T2 Casing	39	1527 T3 Sym Casing	60
902 L2 Lintel	68	1105 T2 Casing	57	1172 T2 Casing	40	1528 T4 Sym Casing	60
903 L2 Lintel	68	1111B-T2 Casing	39	1173B-T2 Casing	39	1529 T4 Sym Casing	60
904 L2 Lintel	68	1111-T2 Casing	39	1173 T2 Casing	40	1530 T2 Casing	49
905 L2 Lintel	68	1113-T2 Casing	52	1174 T2 Casing	55	1531B-T4 Sym Casing	64



Profile #	Pg #	Profile #	Pg #	Profile #	Pg #	Profile #	Pg #
1531 T4 Sym Casing	62						
1532 T3 Sym Casing	63						
1560 T3 Casing	47						
1561 T2 Casing	49						
1570 T3 Sym Casing	62						
1580 -T4 Casing	44						
1701-S1 Stop	76						
1720 T3 Symm Casing	63						
1804 T2 Casing	57						
1911 L2 Lintel	67						
1912 L2 Lintel	67						
1913 L2 Lintel	70						
1914 L2 Lintel	68						
1916 L2 Lintel	70						
1917 L1 Lintel	69						
1919 L2 Lintel	69						
1920 L2 Lintel	69						
1922 A1 Backband	77						
2815-T2 Symmetrical Casing	64						
3120 T2 Casing	48						
3121 T3 Casing	46						
3122 T2* Casing	51						
3123-T3 Casing	44						
3131-T2 Casing	51						
3133 T2 Casing	50						
3134B-T4 Casing	43						
3134 T4 Casing	47						
3135 T3 Casing	47						
3136 T4 Casing	44						
3137 T4 Casing	48						
3138 T3 Casing	47						
5100-H4 Architrave	74						
93041-A1 Backband	77						

## C

CS-DB1 Dentil	72
CS-MS1CL Apron	72
CS-MS2M Apron	72
CS-MS3LG Apron	72
CS-OG1 Ogee	72
CS-OV1 Apron Ovolo	72
CS-SC1 Canted Top Shelf	72
CS-SC2 MOULDED SHELF	72
CS-SC3 Canted Top Shelf	72

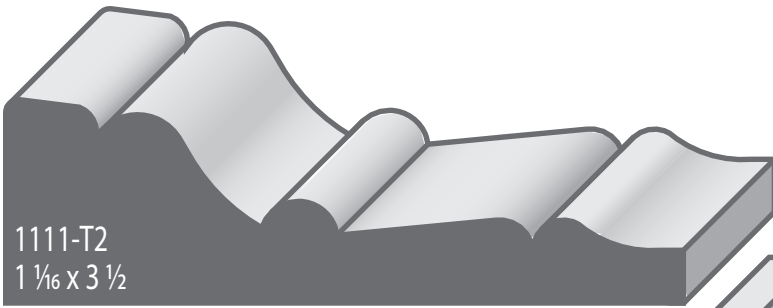

1111-T2  
1 1/16 X 3 1/2

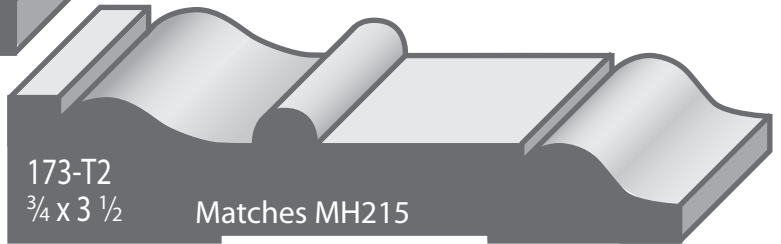

173-T2  
3/4 X 3 1/2  
Matches MH215



1111B-T2  
1 3/32 X 3 1/2



1176-T2  
13/16 X 3 1/2

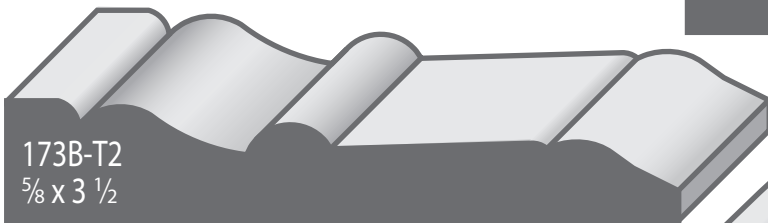

173B-T2  
5/8 X 3 1/2

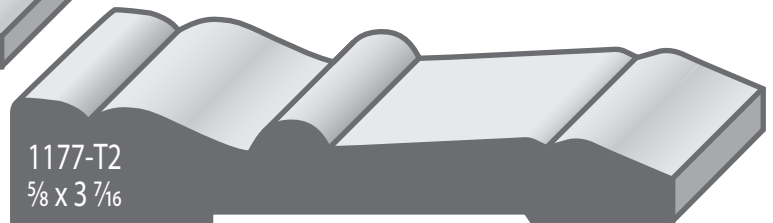

1177-T2  
5/8 X 3 7/16

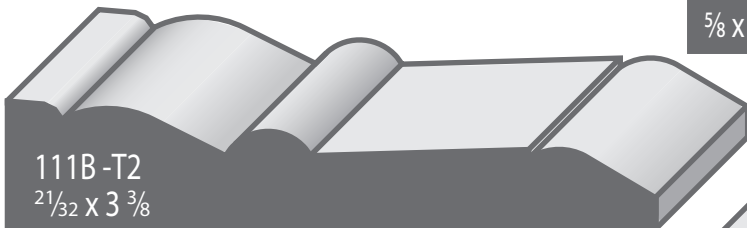

111B-T2  
2 1/32 X 3 3/8

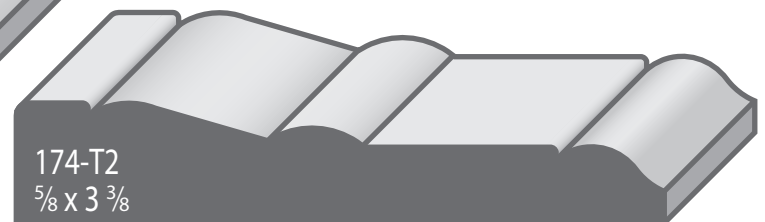

174-T2  
5/8 X 3 3/8



1171-T2  
2 1/32 X 3 5/16

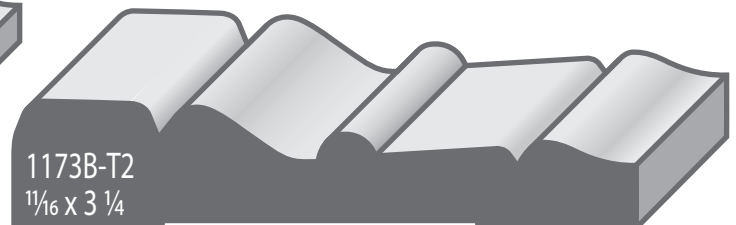

1173B-T2  
1 1/16 X 3 1/4

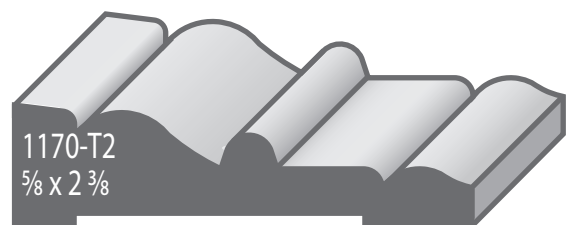
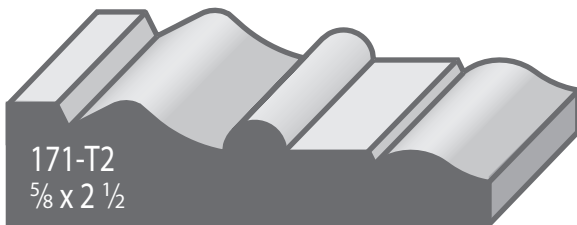
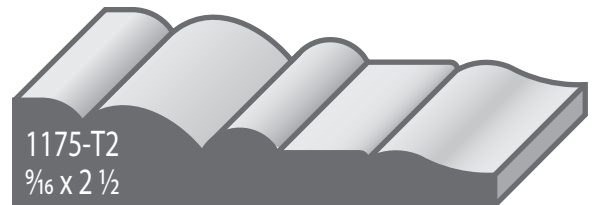
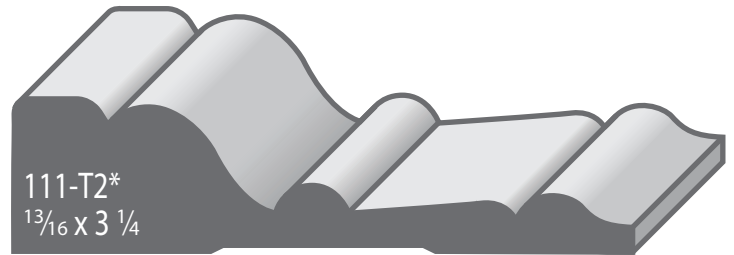
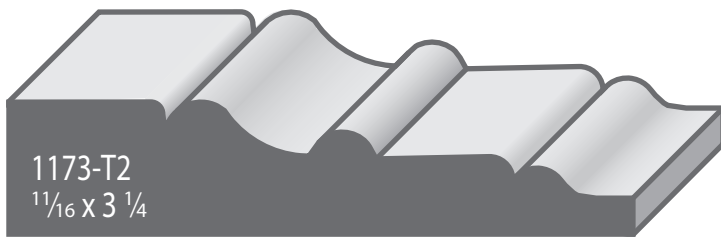

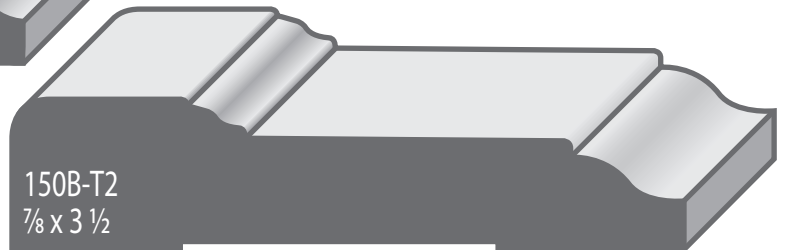
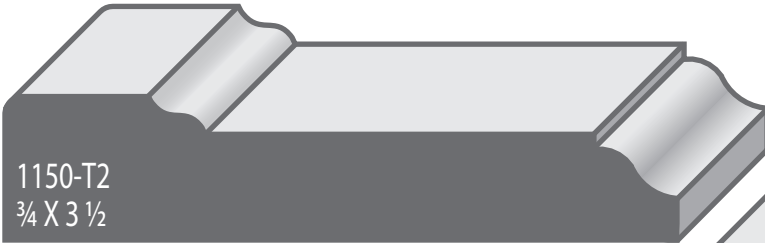
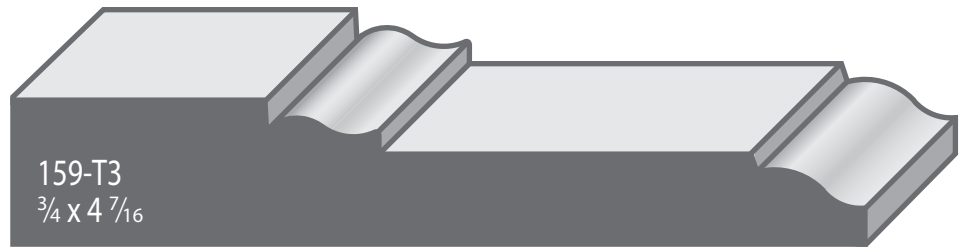
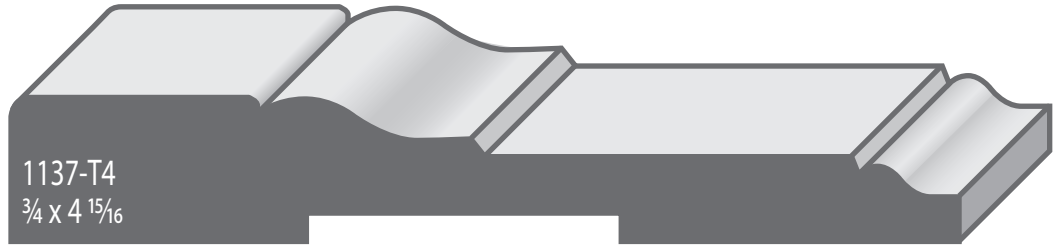

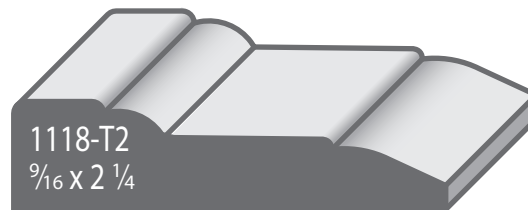
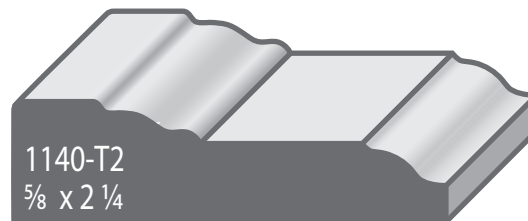
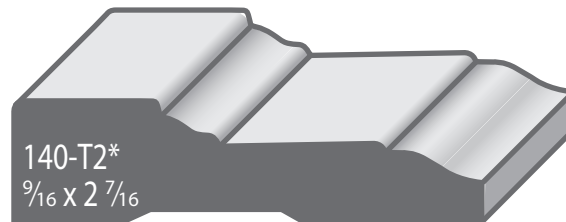
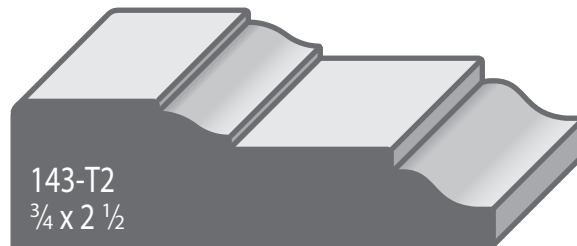
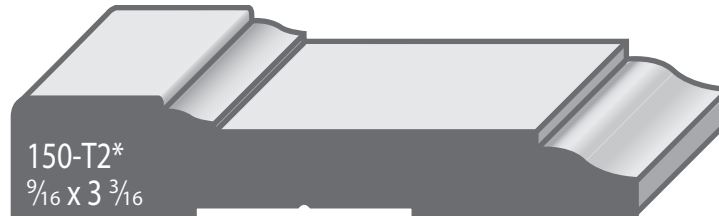

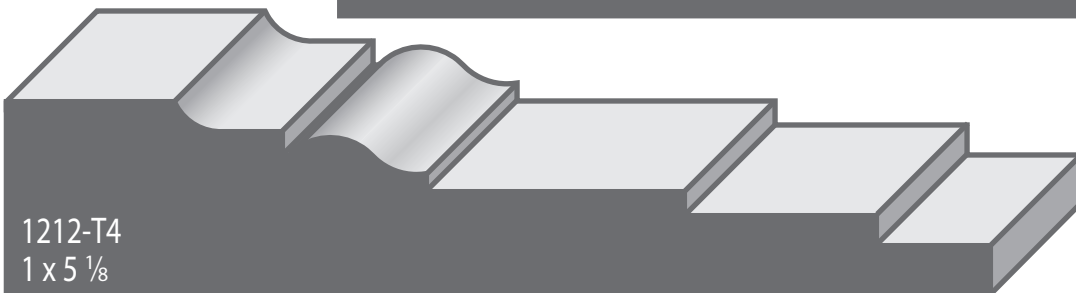
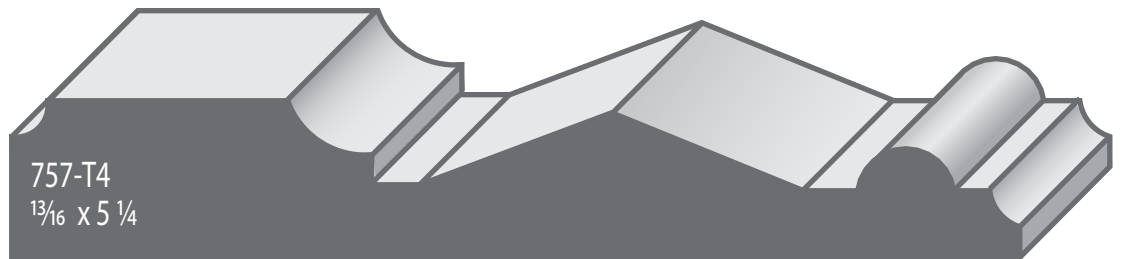
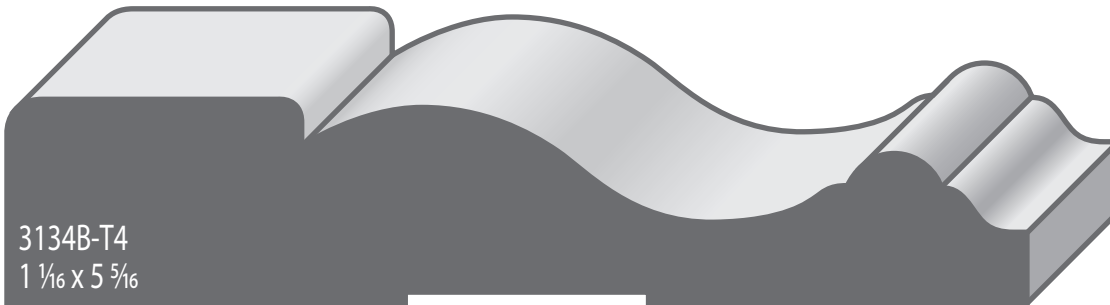
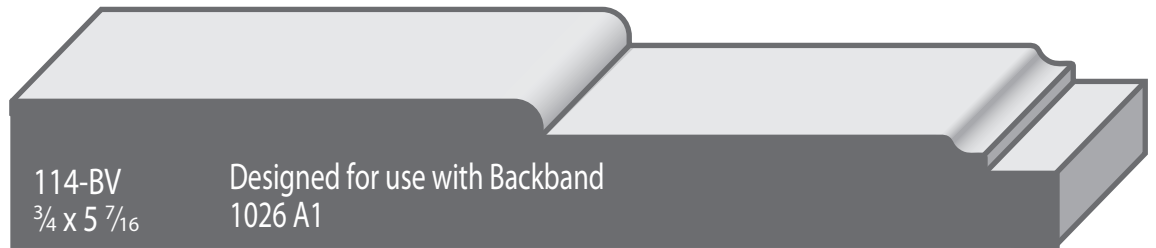
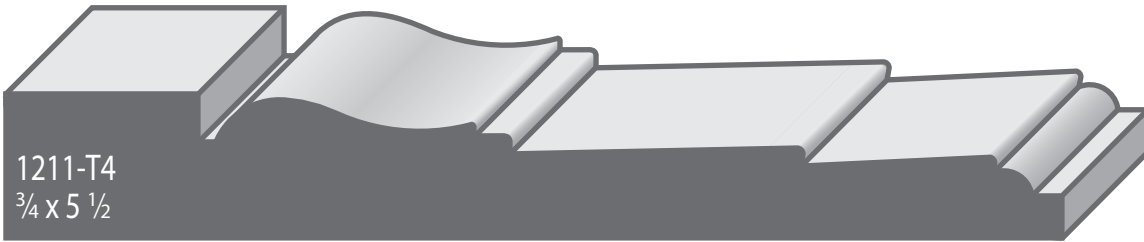
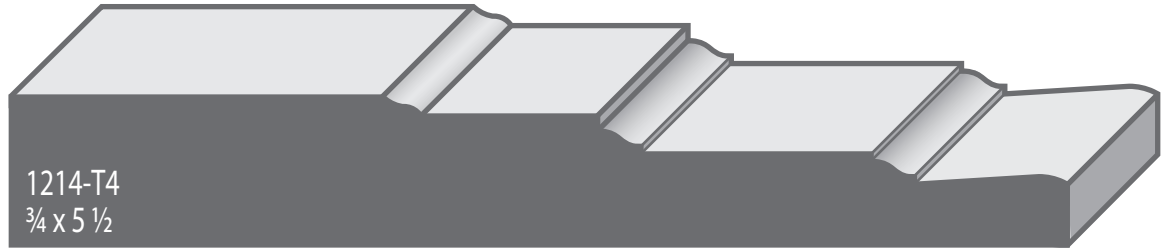



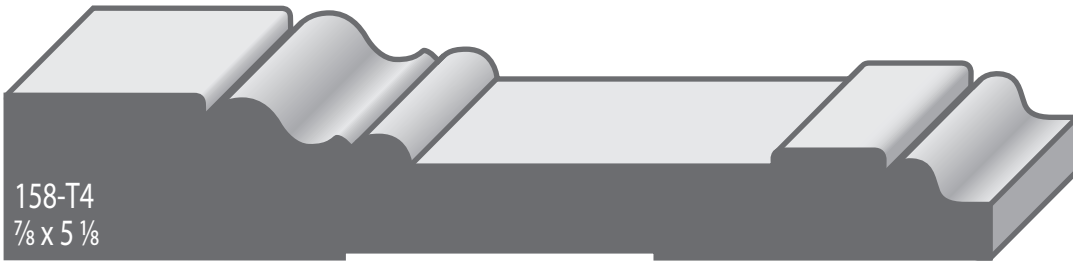

158-T4  
7/8 x 5 1/8

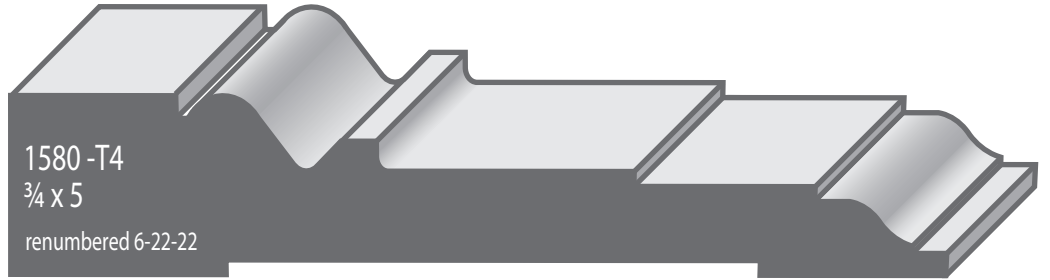

1580-T4  
3/4 x 5  
renumbered 6-22-22



1139-T3  
3/4 x 4 29/32

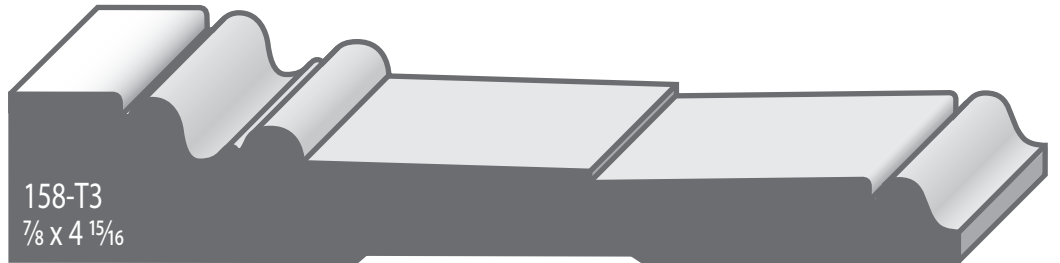

158-T3  
7/8 x 4 15/16

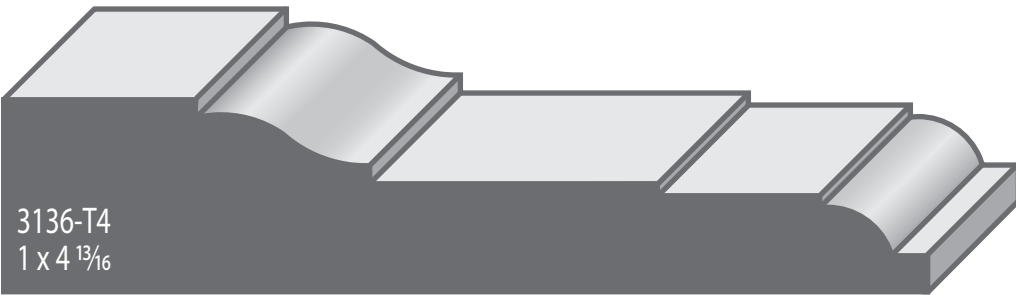

3136-T4  
1 x 4 13/16

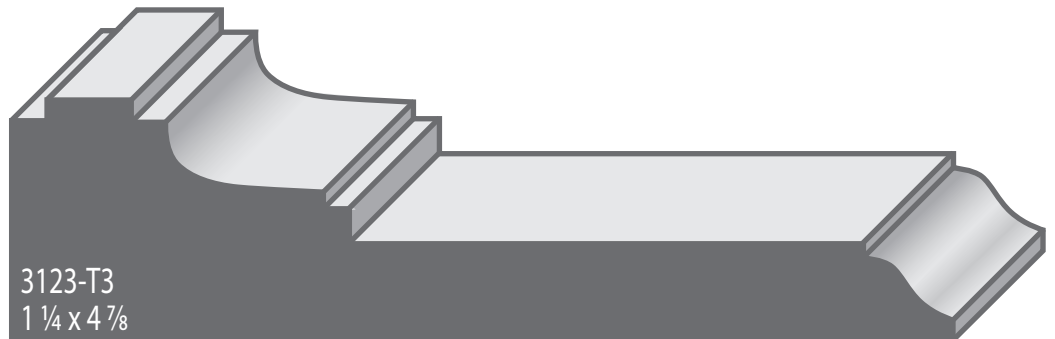

3123-T3  
1 1/4 x 4 7/8

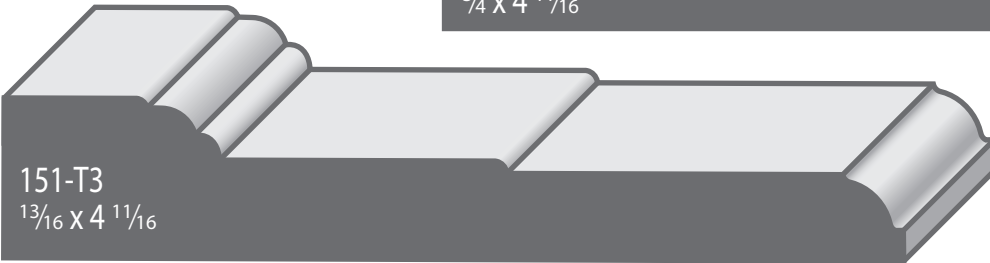
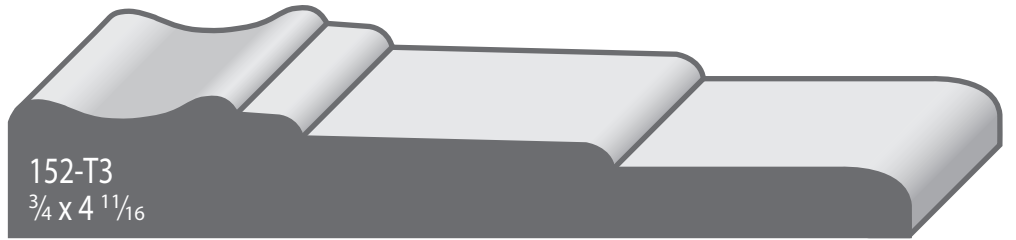
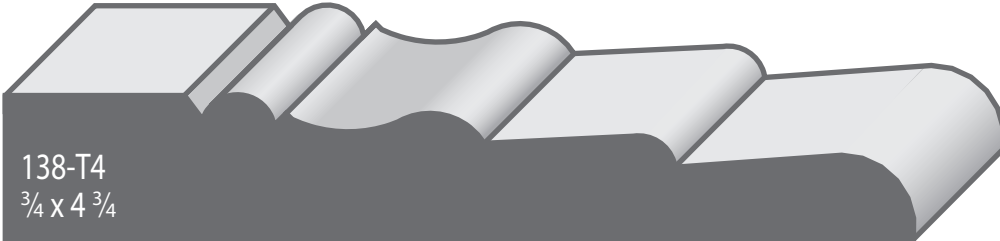
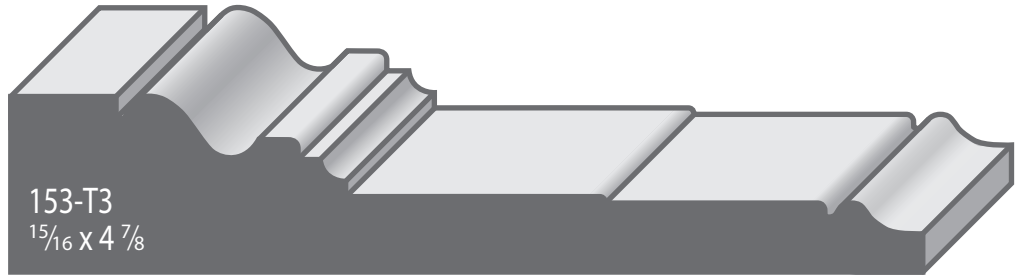

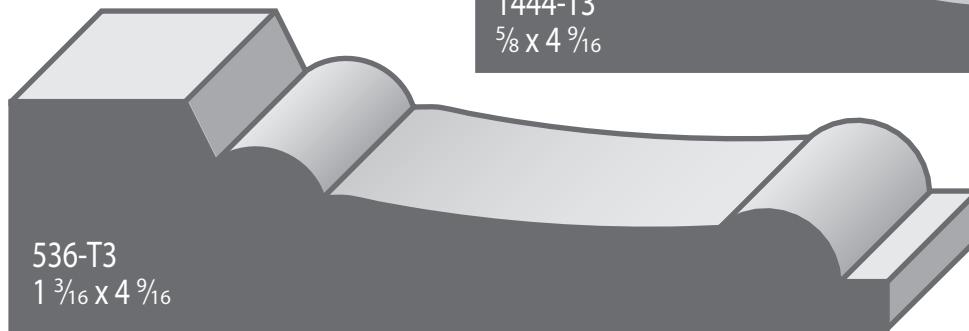
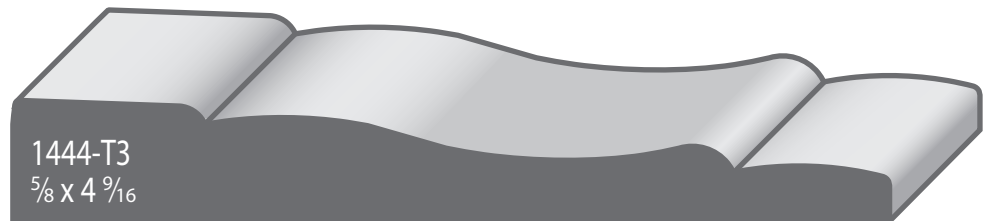
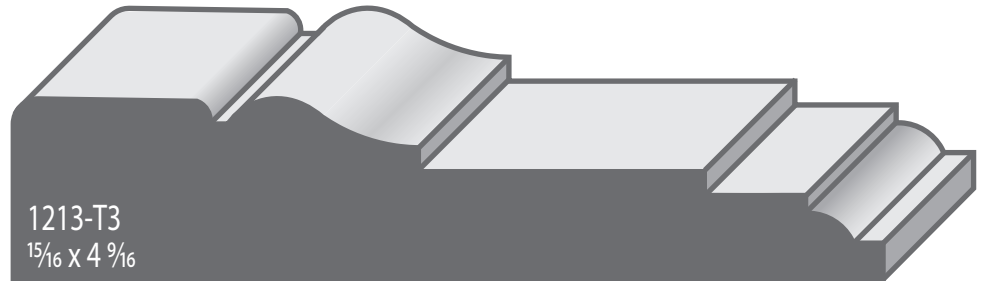
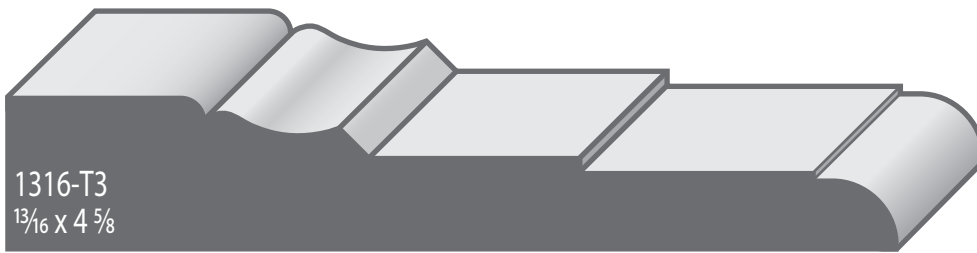

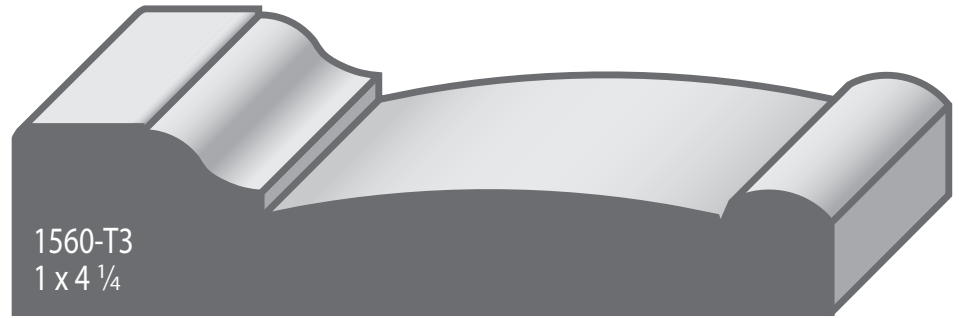
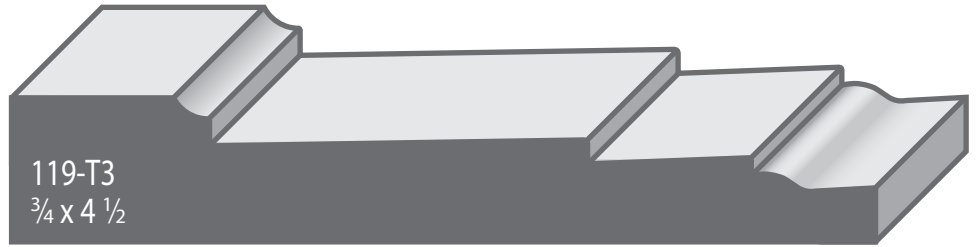
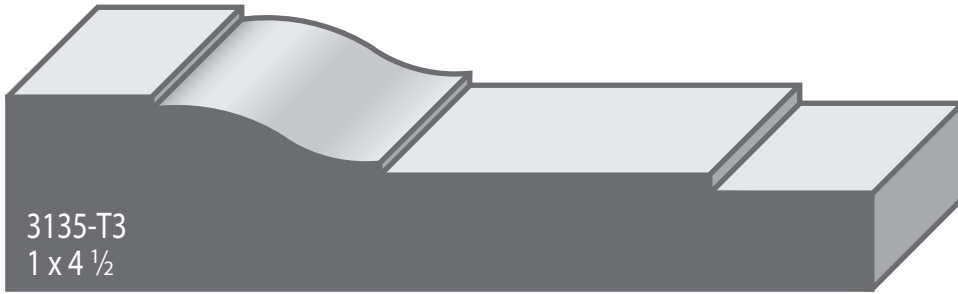

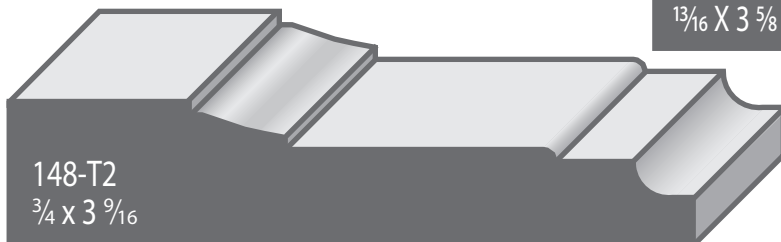
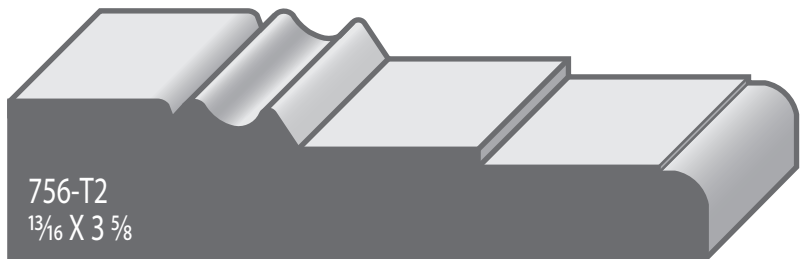
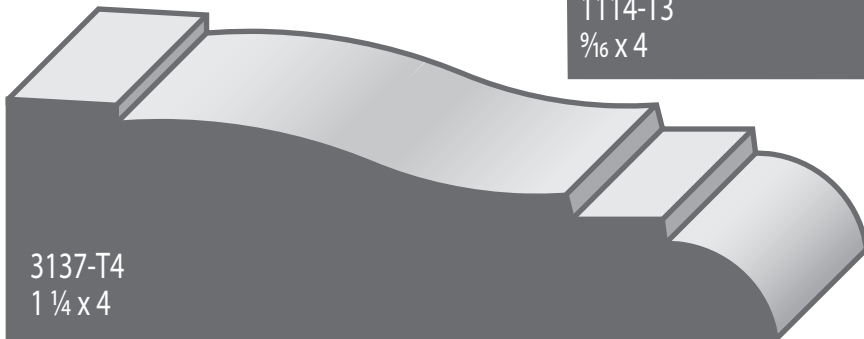
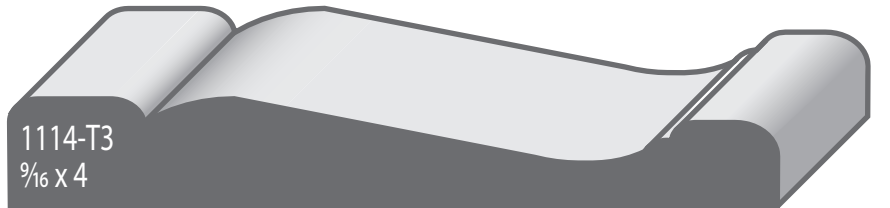
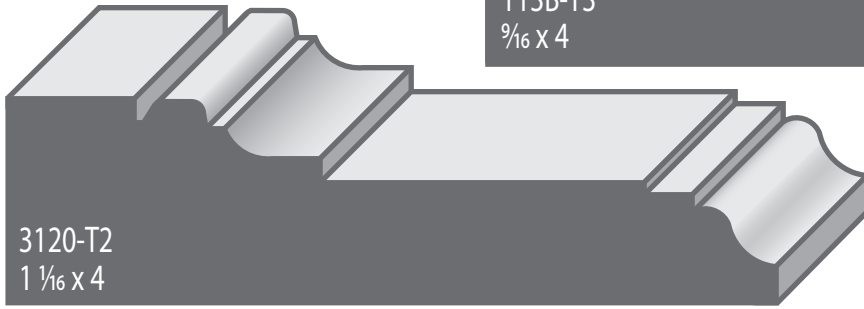
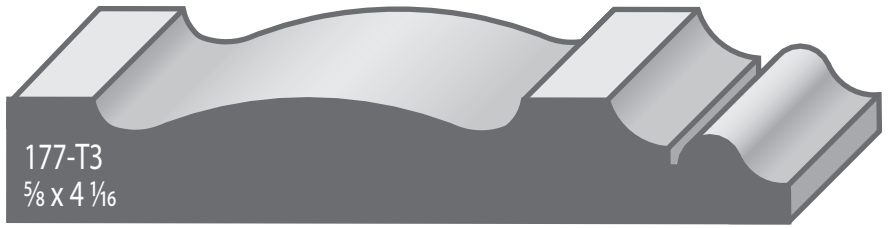

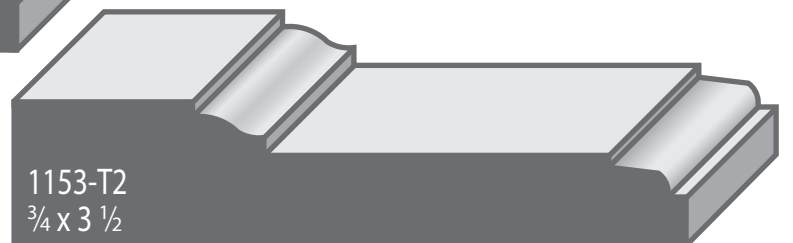
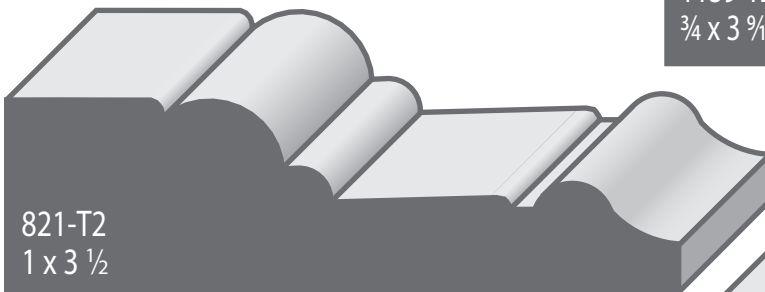
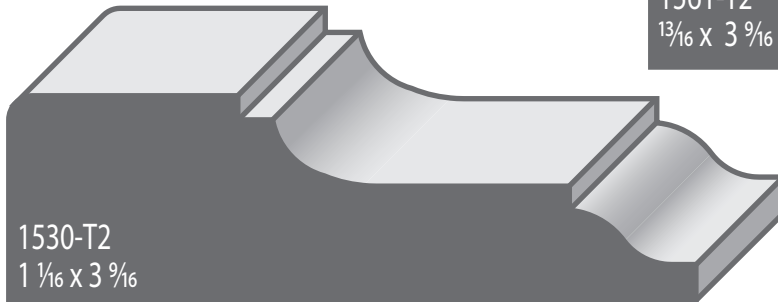

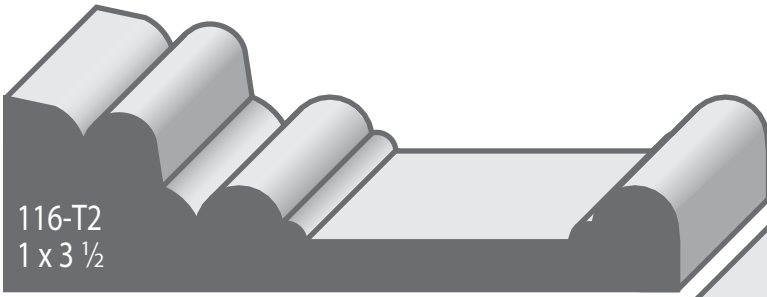

116-T2  
1 x 3 1/2



1139B-TV  
3/4 x 3 1/2

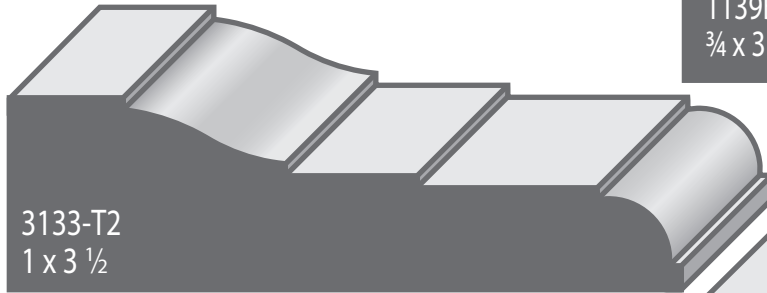

3133-T2  
1 x 3 1/2

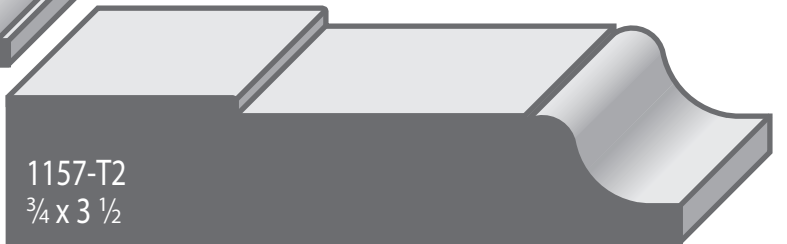

1157-T2  
3/4 x 3 1/2

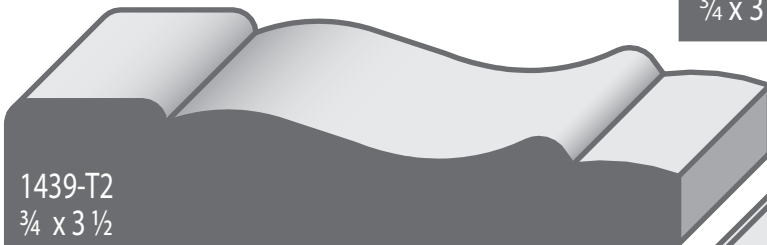

1439-T2  
3/4 x 3 1/2



1159-T2  
1 x 3 1/2



1152-T2  
1 3/16 x 3 1/2

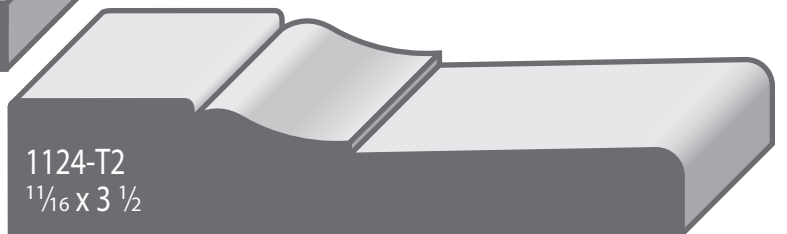

1124-T2  
1 1/16 x 3 1/2

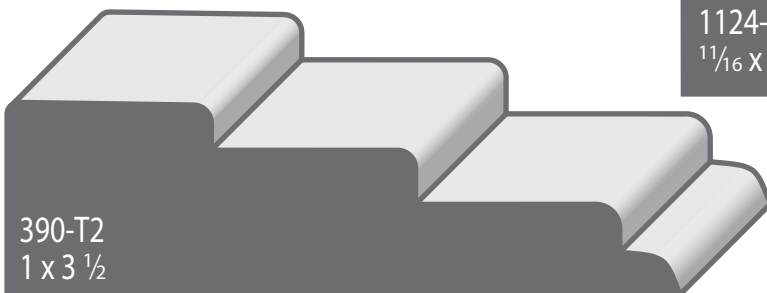

390-T2  
1 x 3 1/2

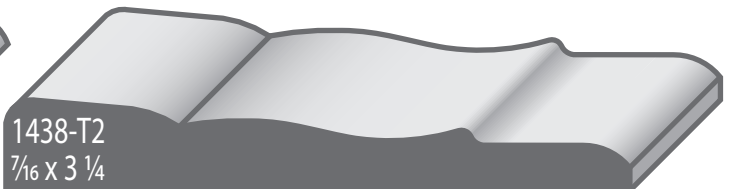
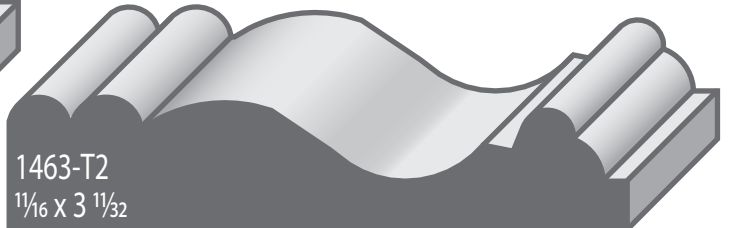
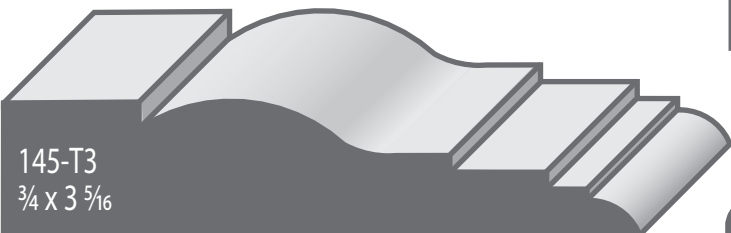
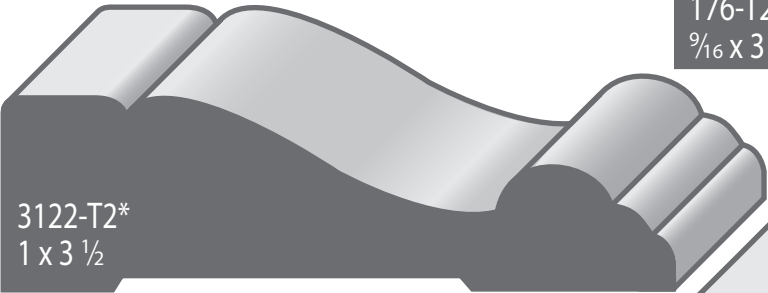
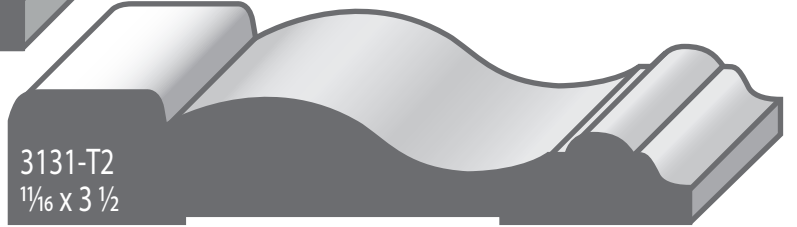
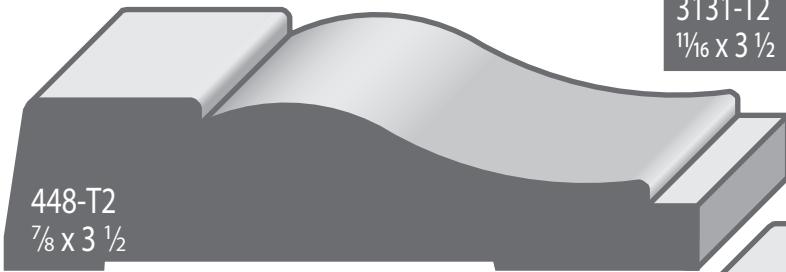
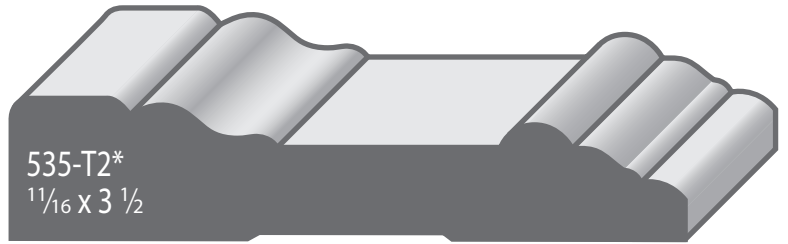
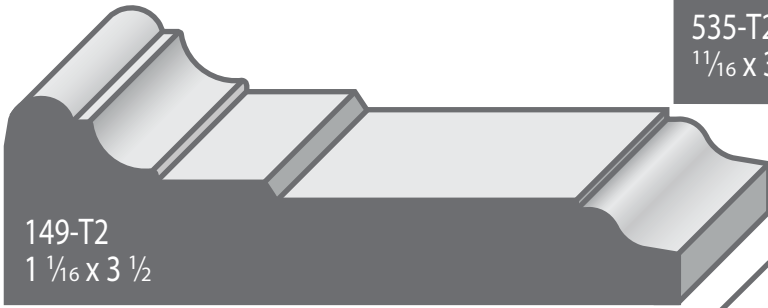



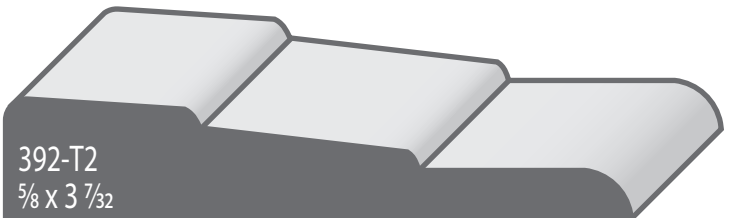
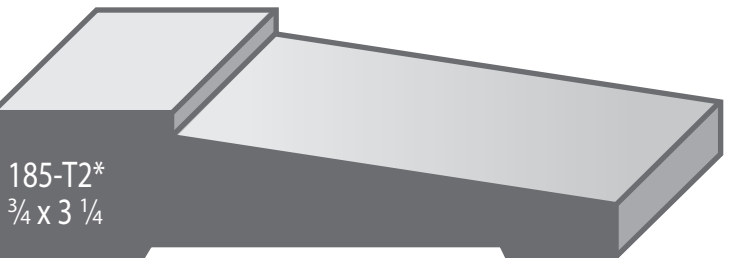
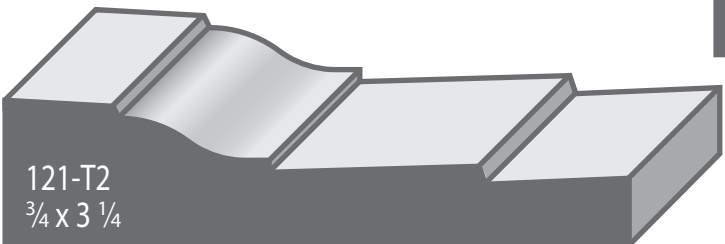
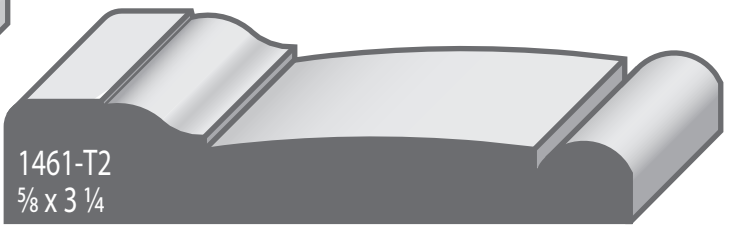
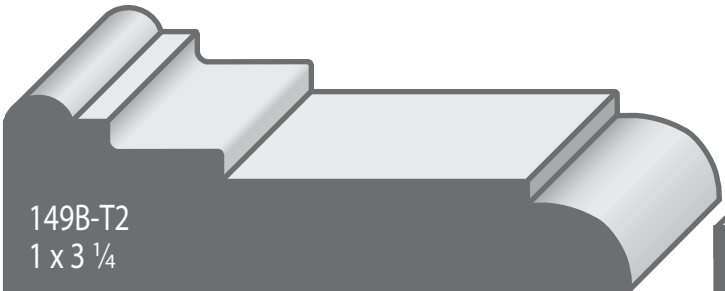
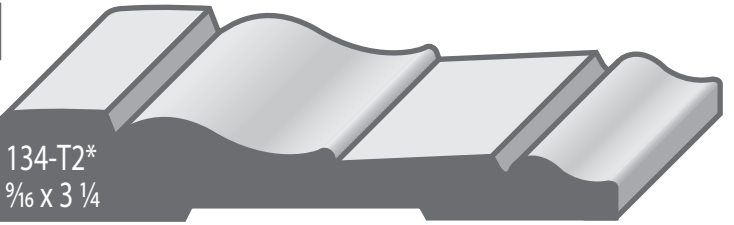
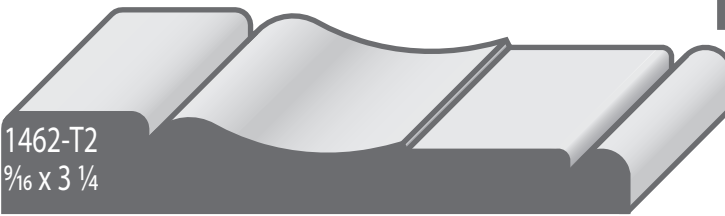
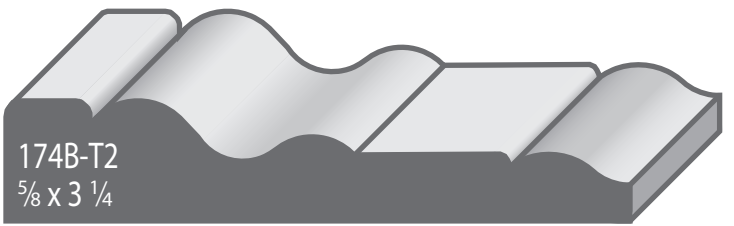
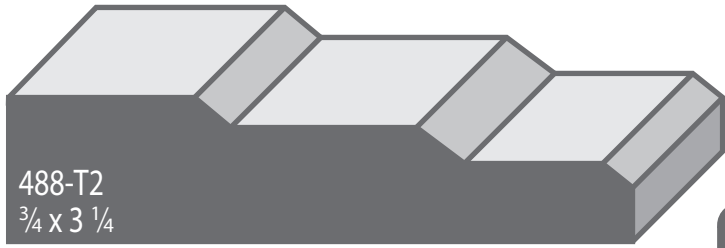
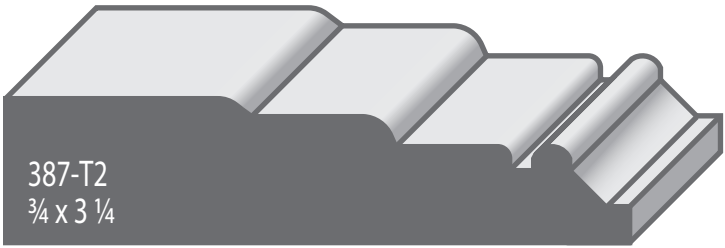
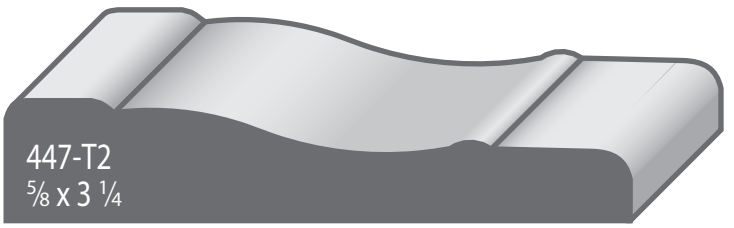
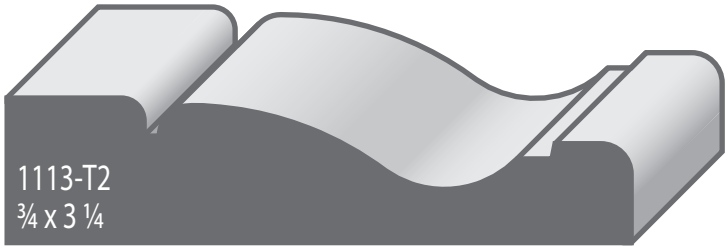

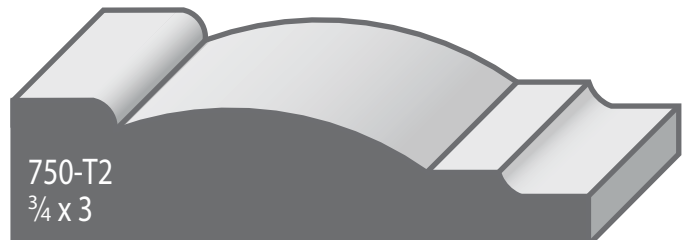
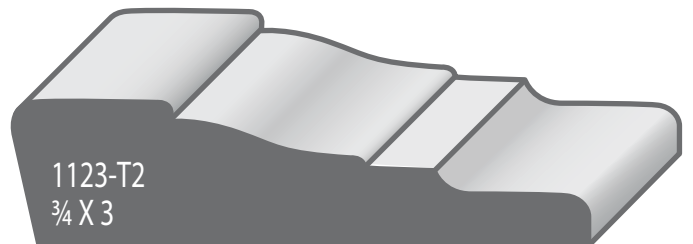
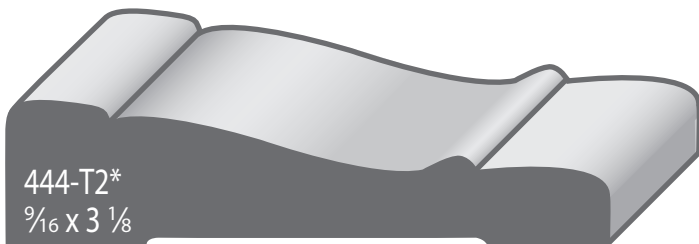
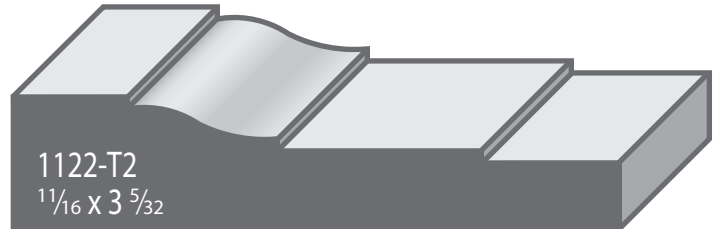
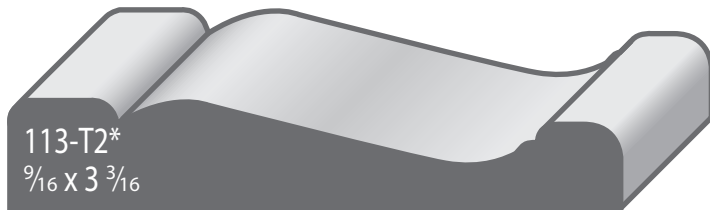
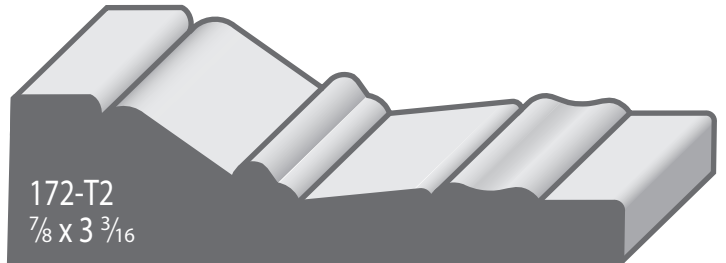
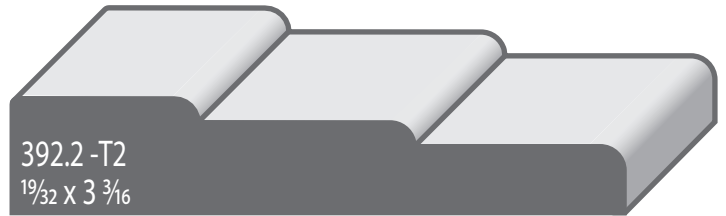
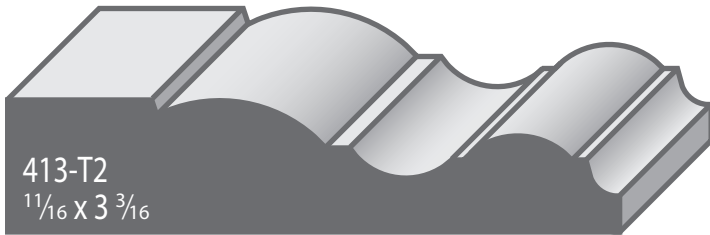
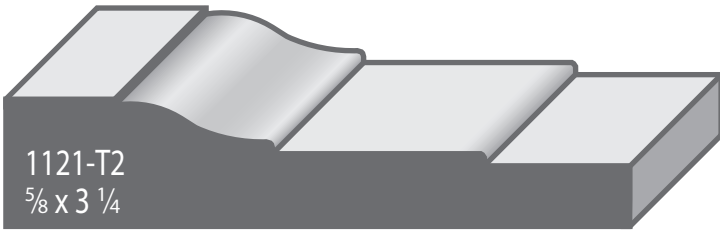

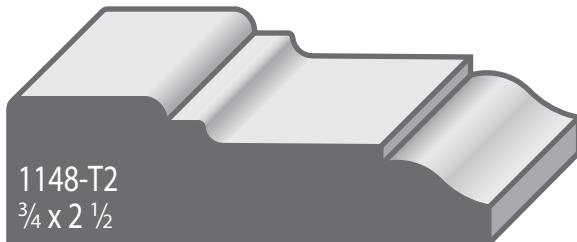
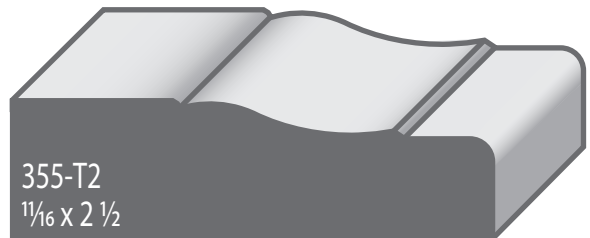
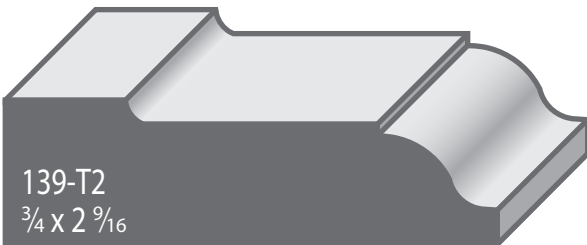
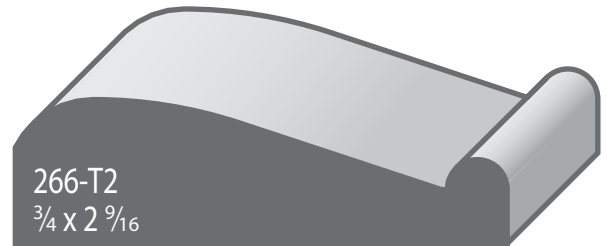
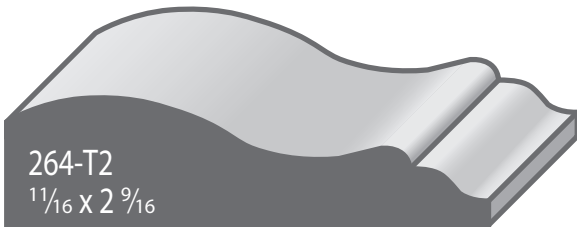
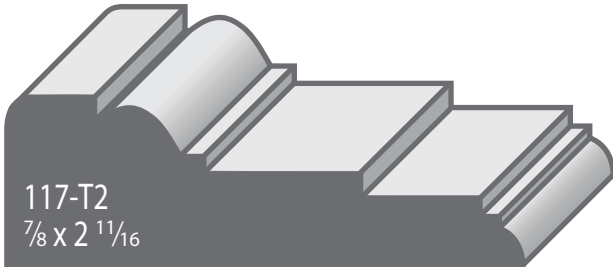
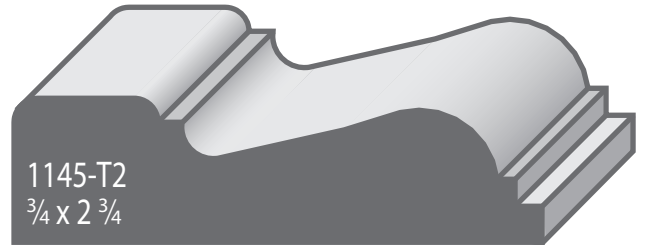
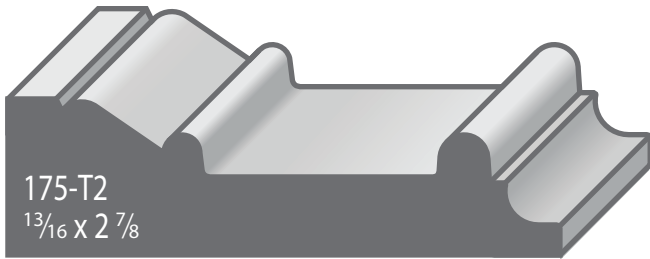
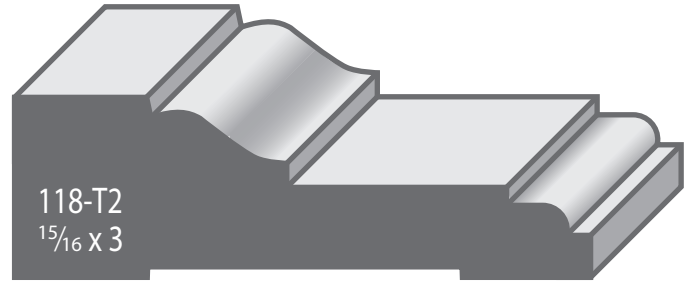
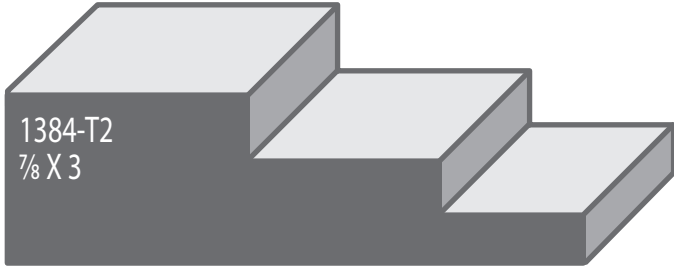
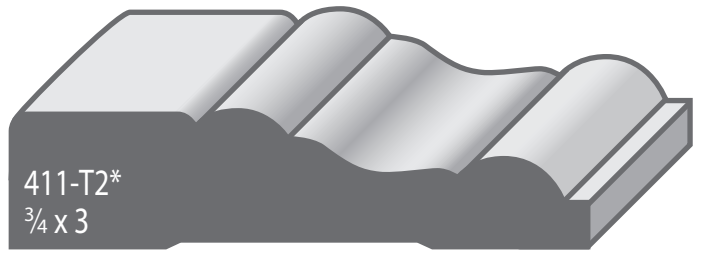
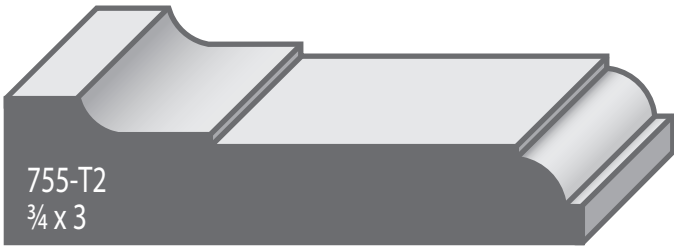

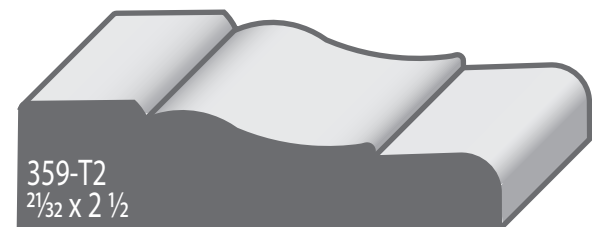
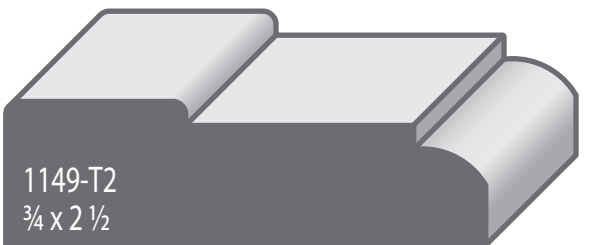
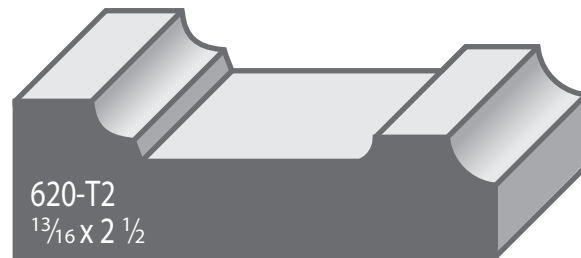
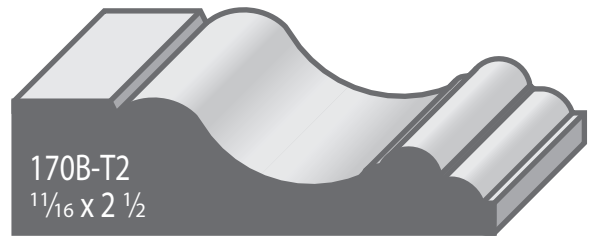
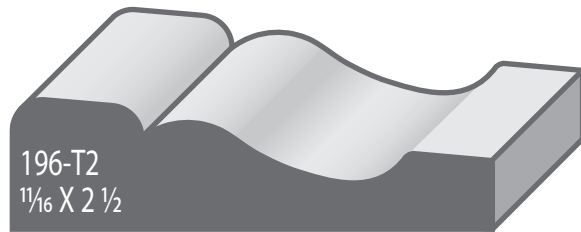
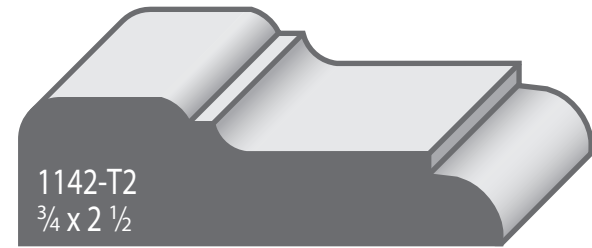
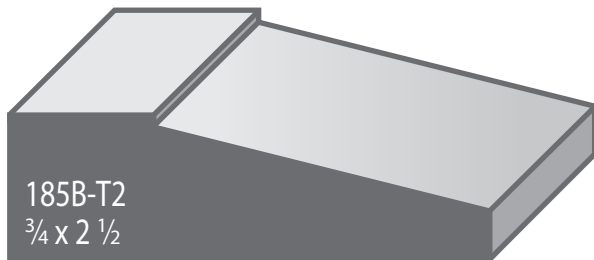
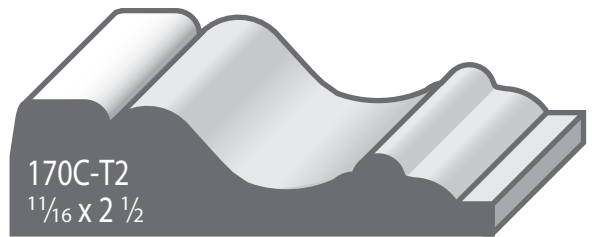
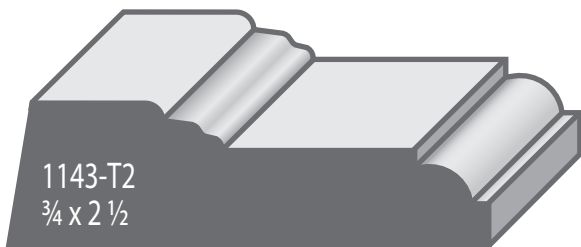
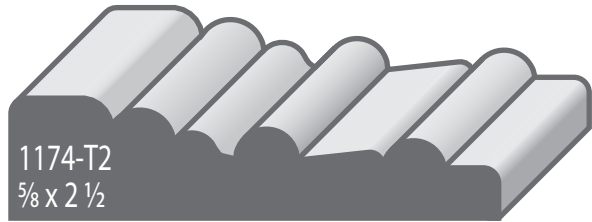
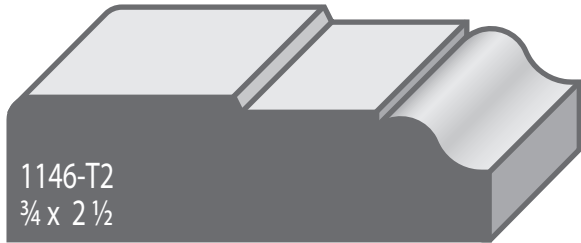
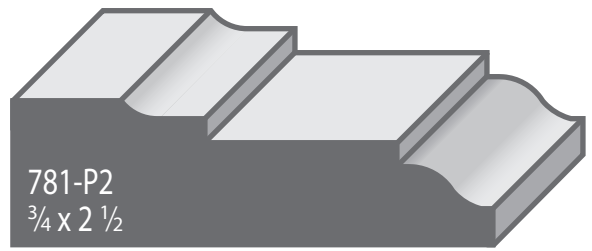
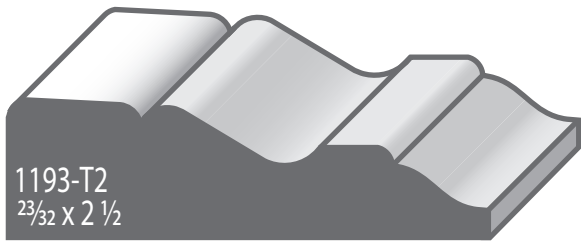

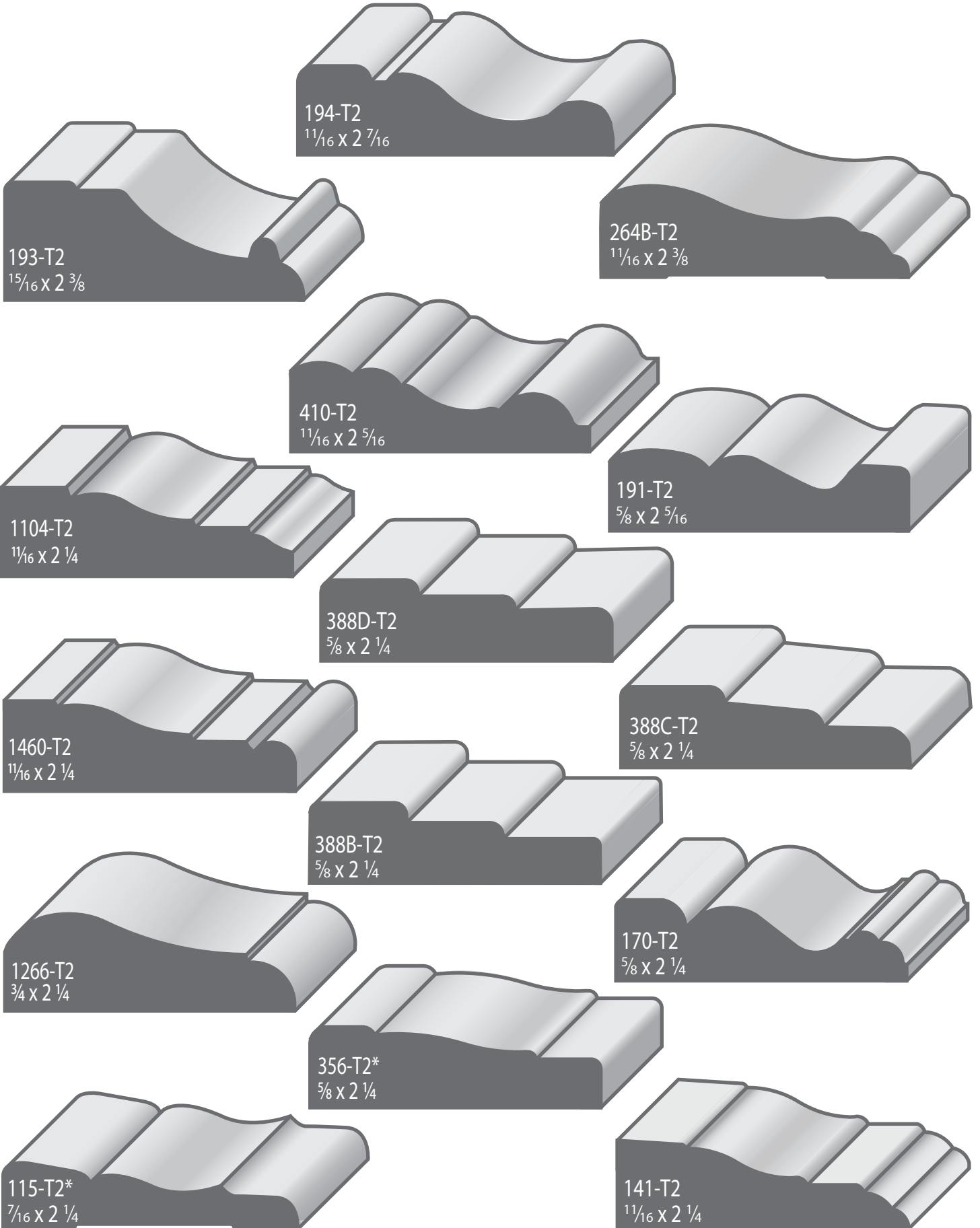



808-T2  
 $\frac{3}{4} \times 2 \frac{1}{4}$

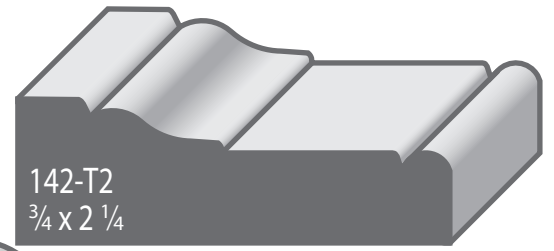

142-T2  
 $\frac{3}{4} \times 2 \frac{1}{4}$

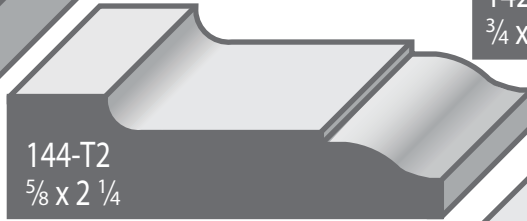

144-T2  
 $\frac{5}{8} \times 2 \frac{1}{4}$

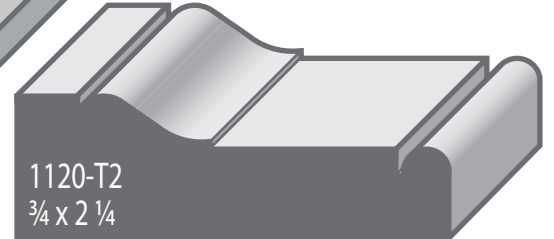

1120-T2  
 $\frac{3}{4} \times 2 \frac{1}{4}$

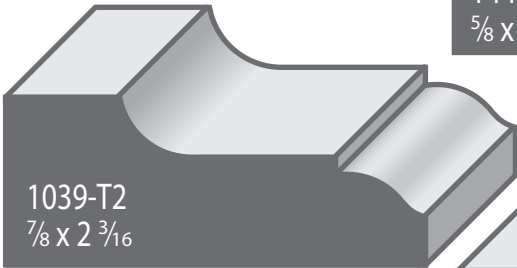

1039-T2  
 $\frac{7}{8} \times 2 \frac{3}{16}$

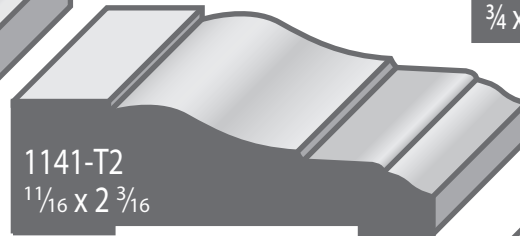

1141-T2  
 $1 \frac{1}{16} \times 2 \frac{3}{16}$

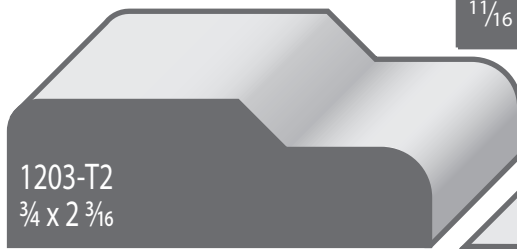

1203-T2  
 $\frac{3}{4} \times 2 \frac{3}{16}$

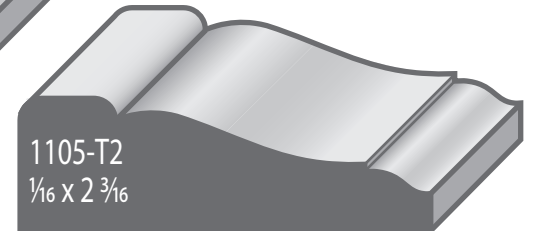

1105-T2  
 $\frac{1}{16} \times 2 \frac{3}{16}$



357-T2  
 $\frac{9}{16} \times 2 \frac{3}{16}$

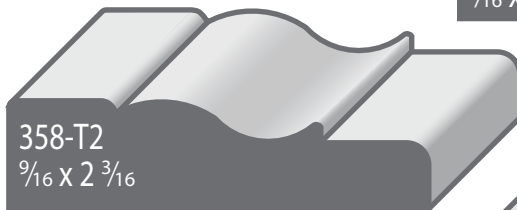

358-T2  
 $\frac{9}{16} \times 2 \frac{3}{16}$

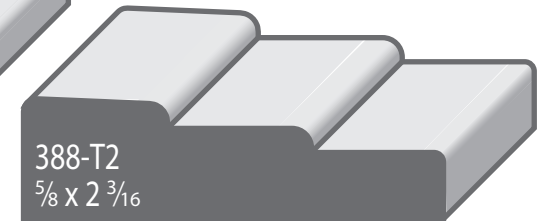

388-T2  
 $\frac{5}{8} \times 2 \frac{3}{16}$

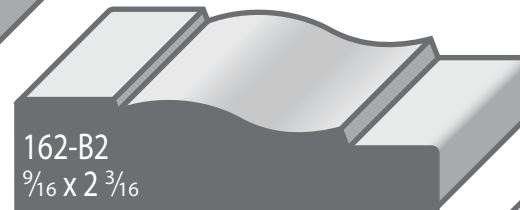

162-B2  
 $\frac{9}{16} \times 2 \frac{3}{16}$



248-P2  
1 x 2

Pair with Plinth #1037 T2 and Base 331 BV



1804-T2  
 $\frac{3}{4} \times 2 \frac{1}{8}$

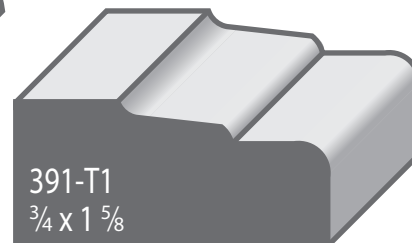

391-T1  
 $\frac{3}{4} \times 1 \frac{5}{8}$



112-T1\*  
 $\frac{1}{2} \times 1 \frac{1}{2}$

[sales@mccoymillwork.com](mailto:sales@mccoymillwork.com)

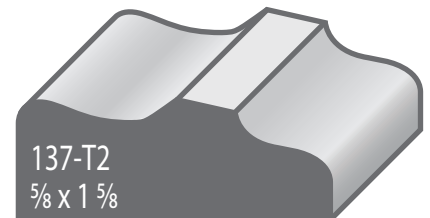

137-T2  
 $\frac{5}{8} \times 1 \frac{5}{8}$

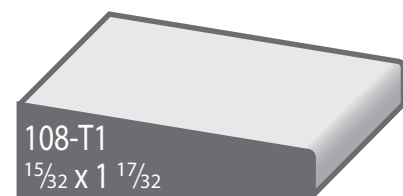
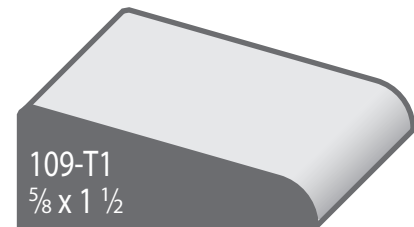
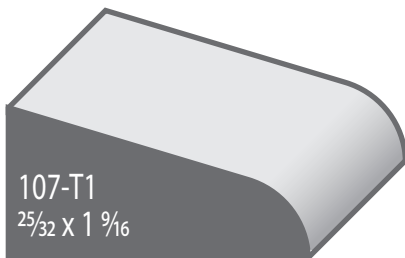
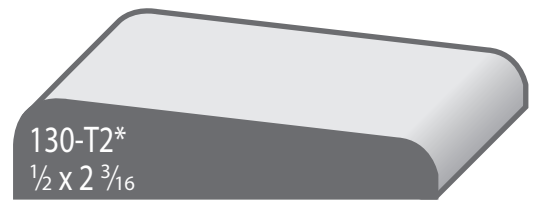
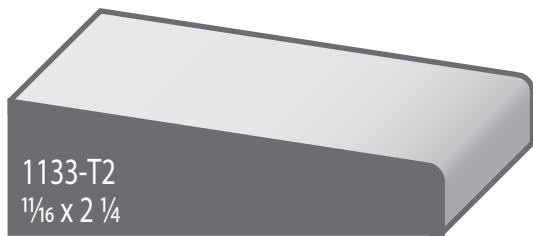
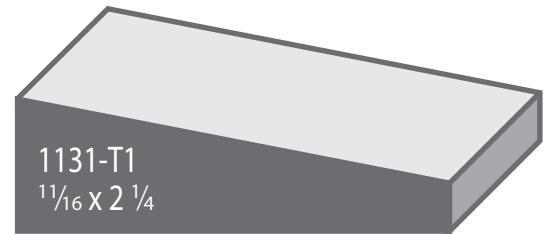
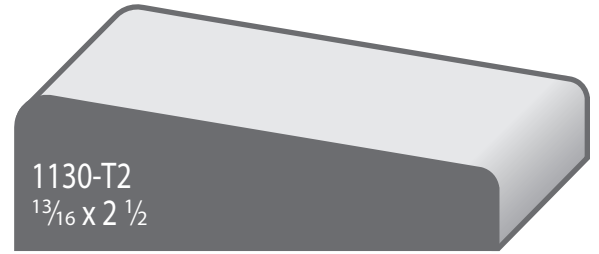
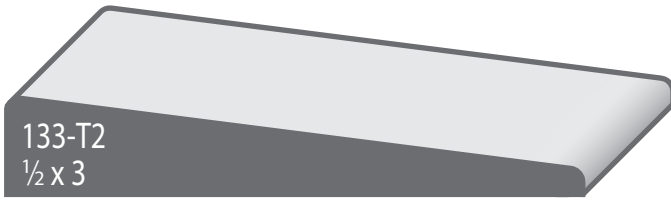

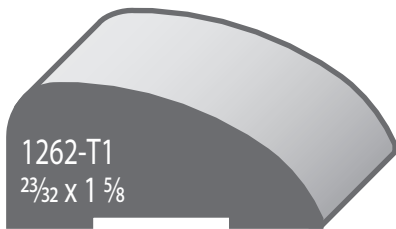
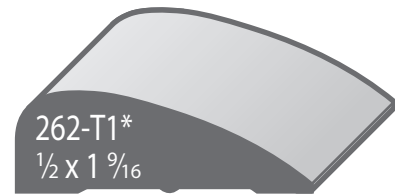
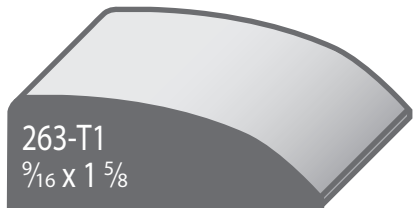
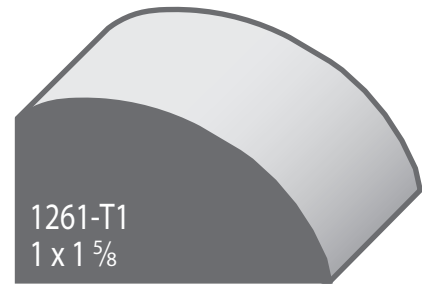
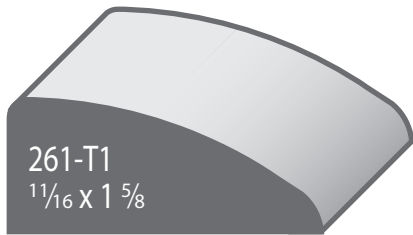
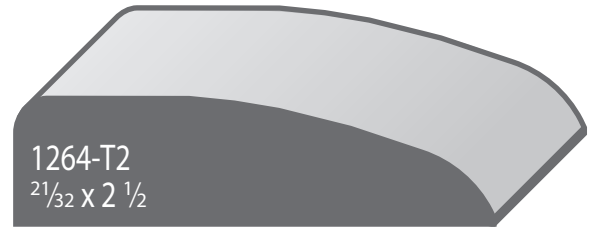



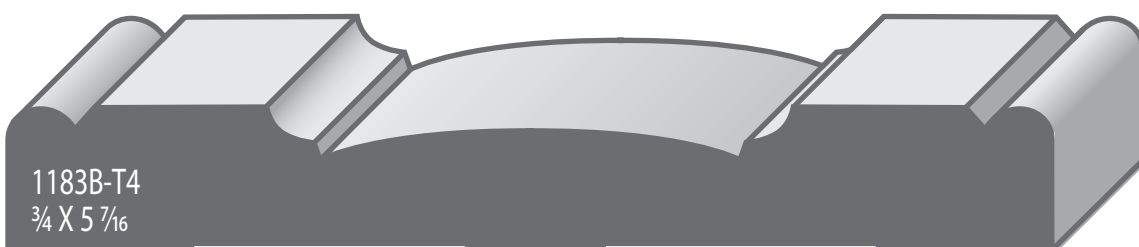
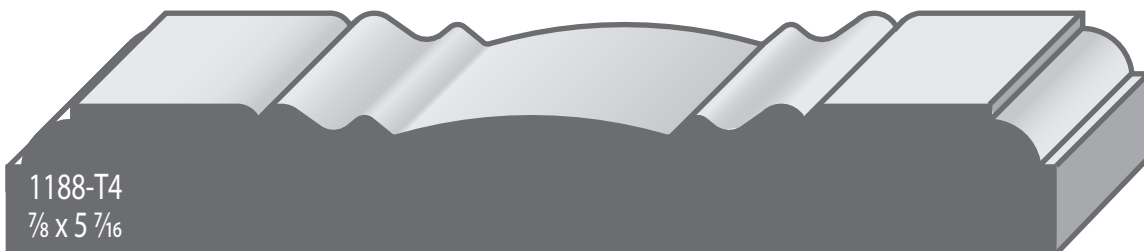
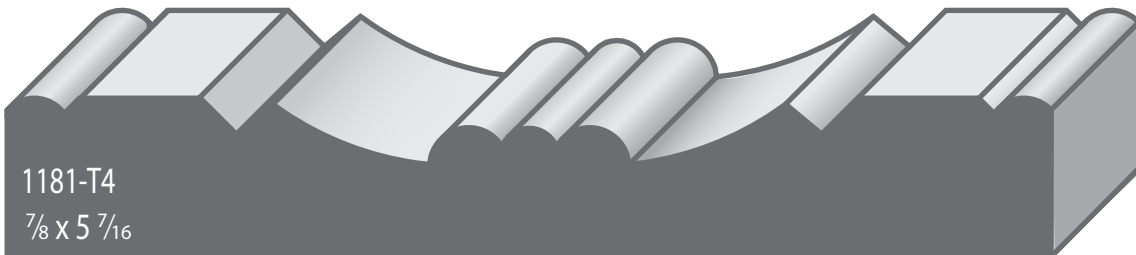
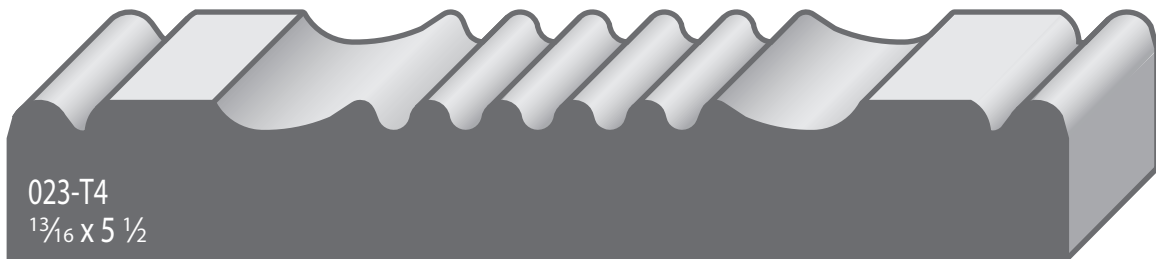

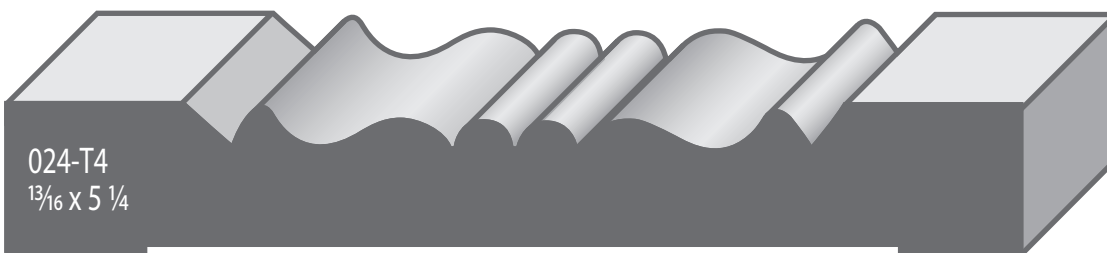
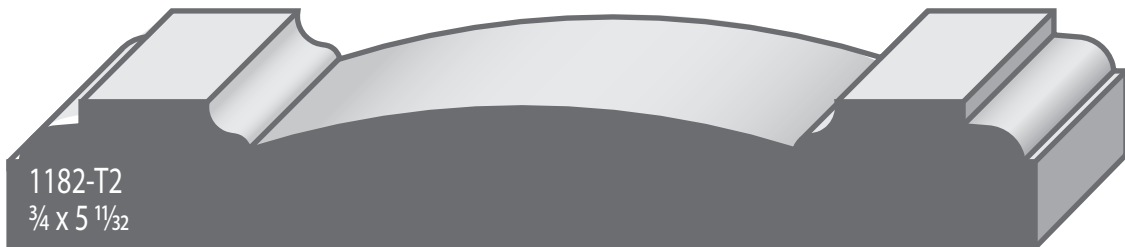
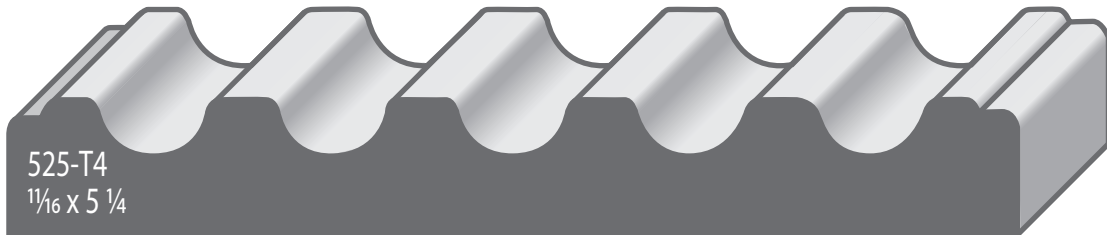
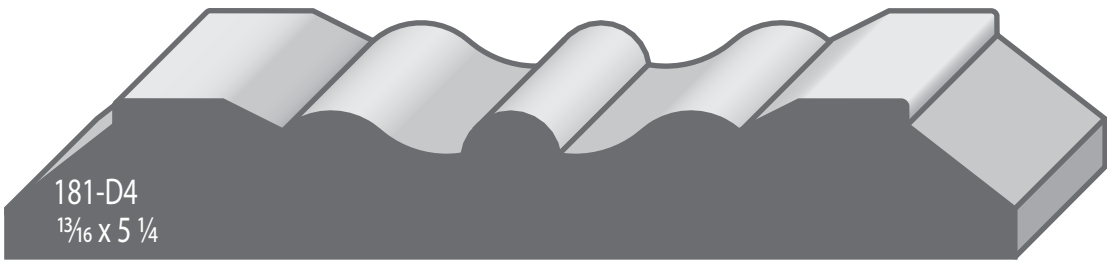
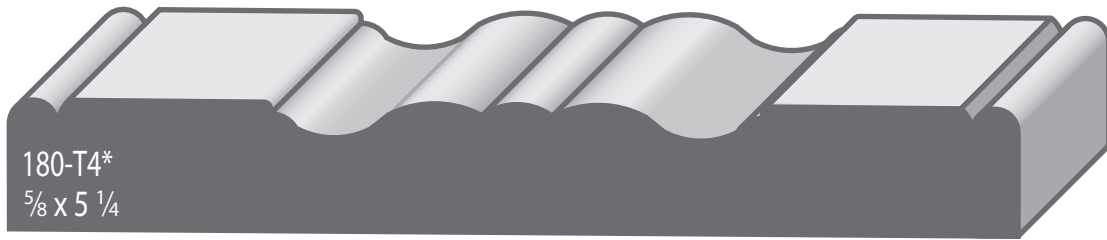

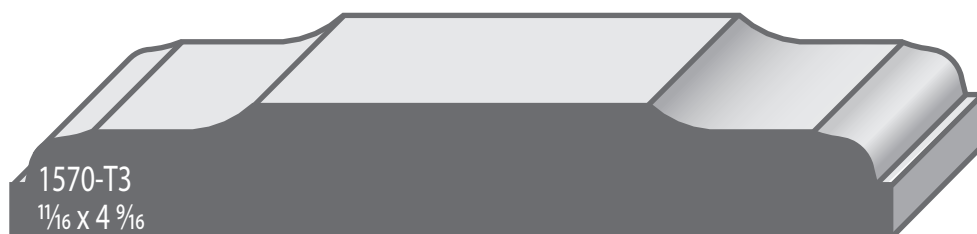
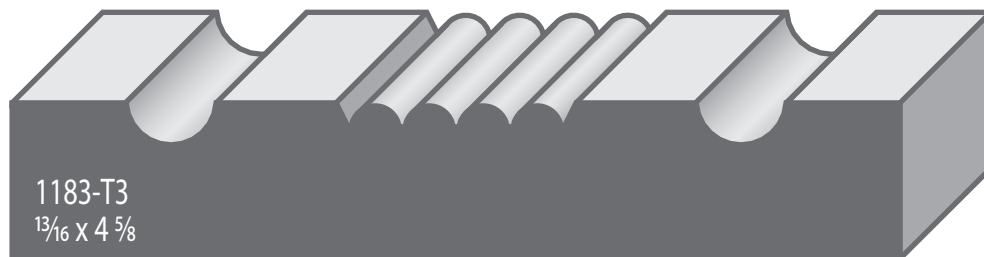
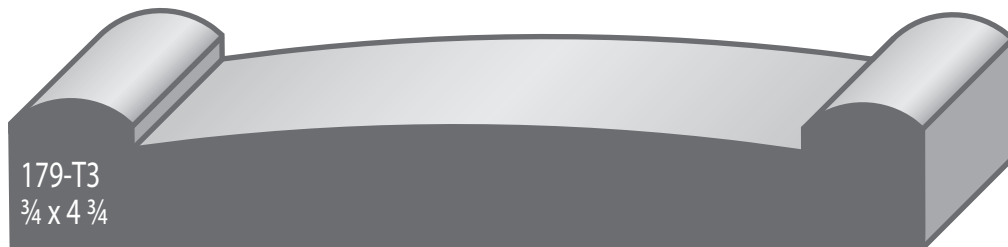
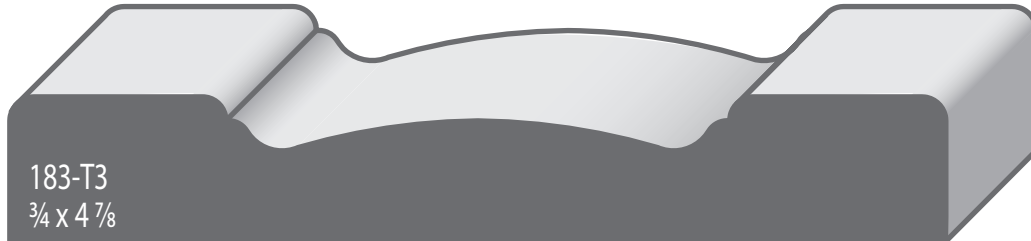
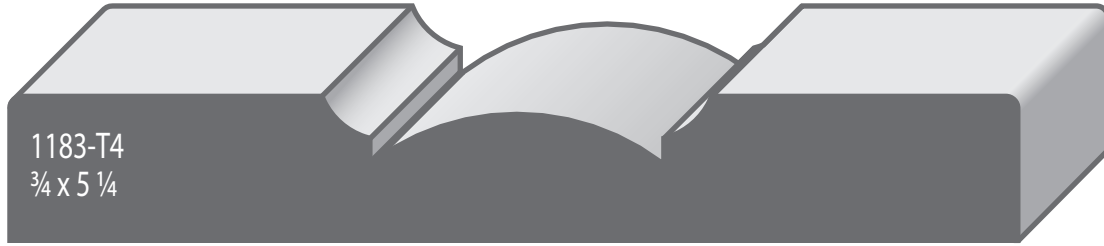

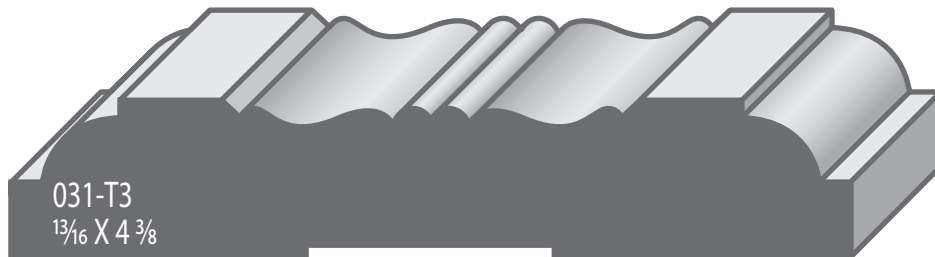
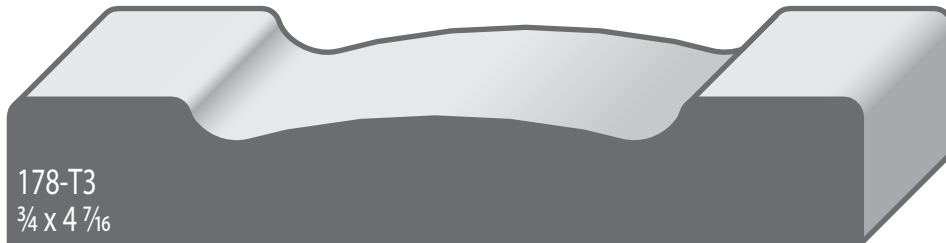
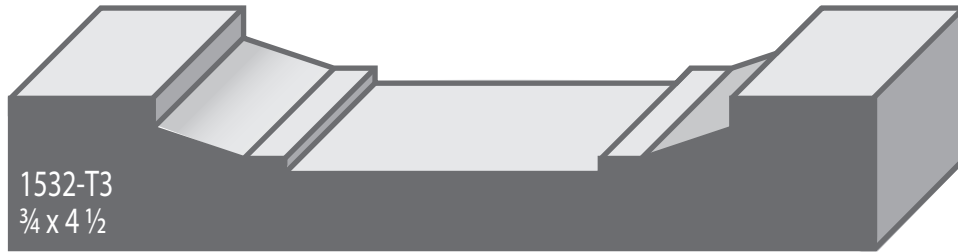
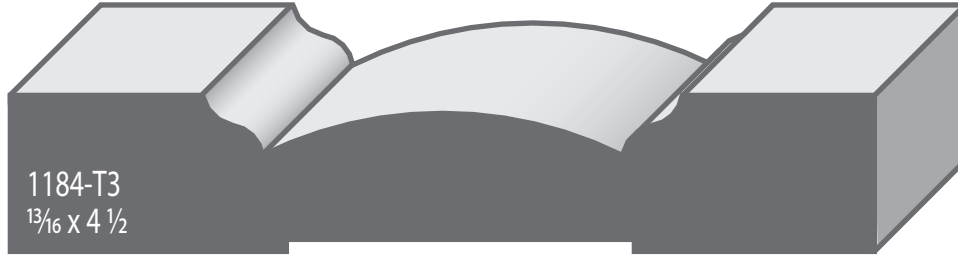
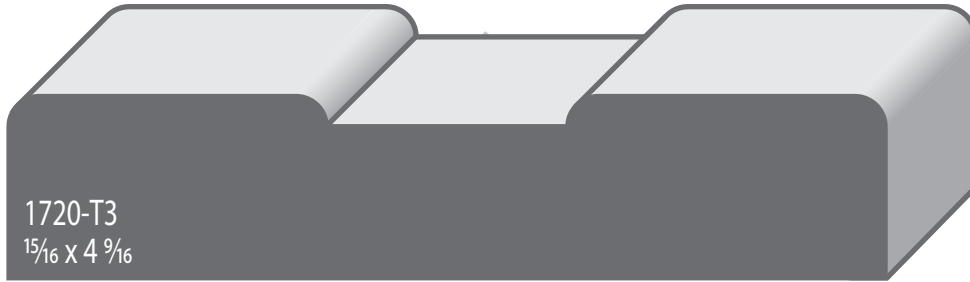

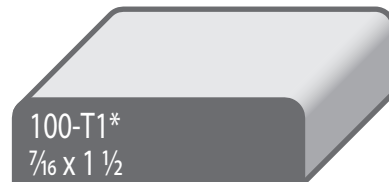
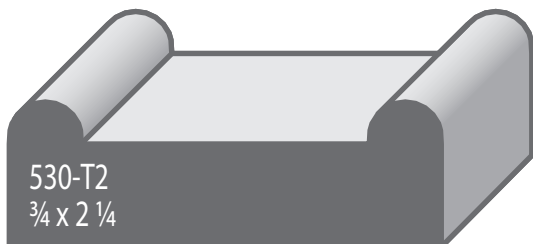
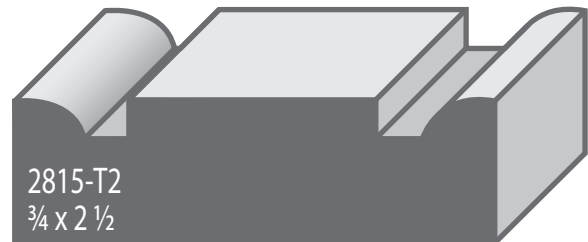
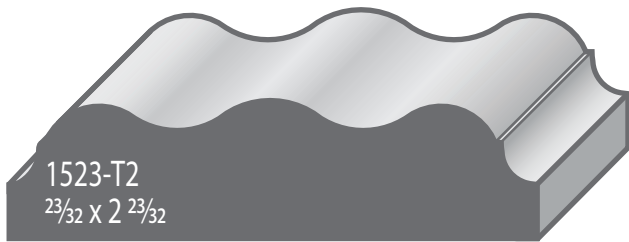
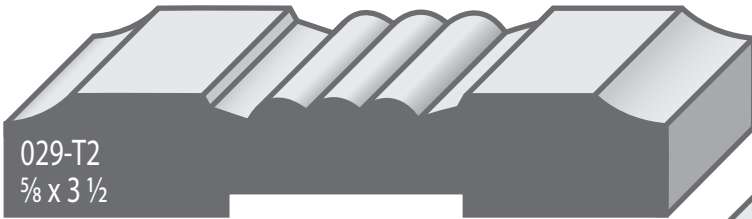
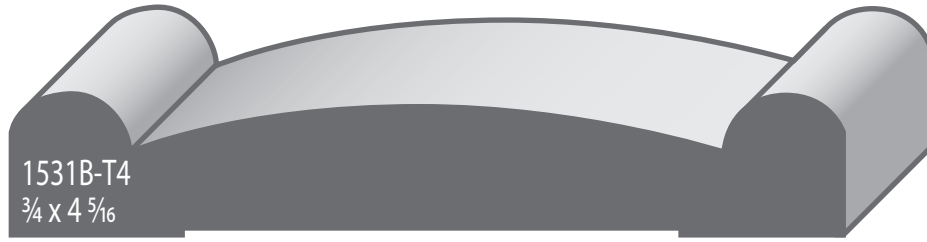

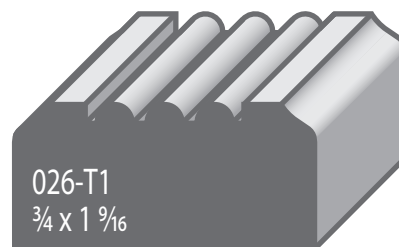
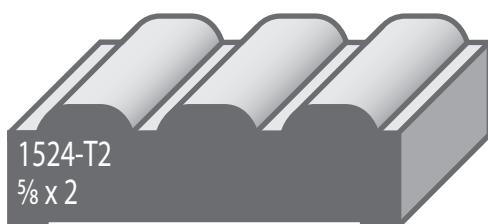
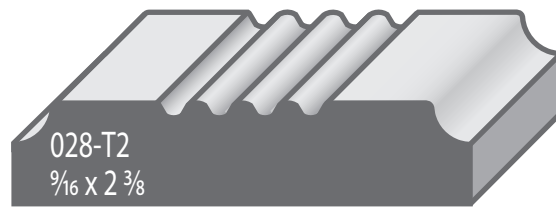
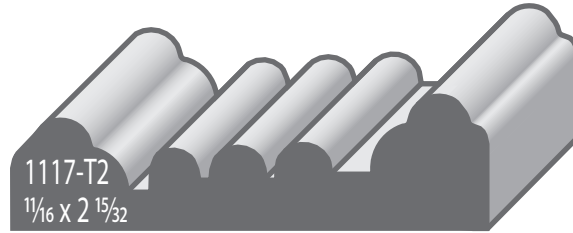
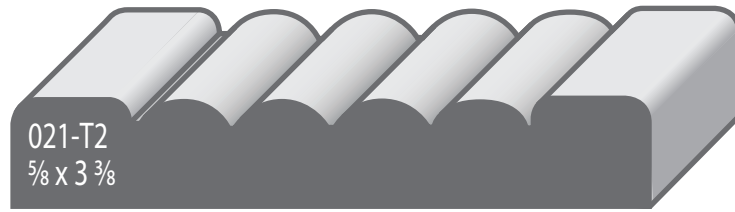

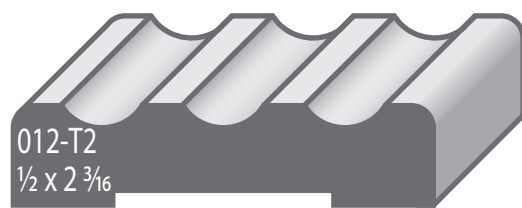
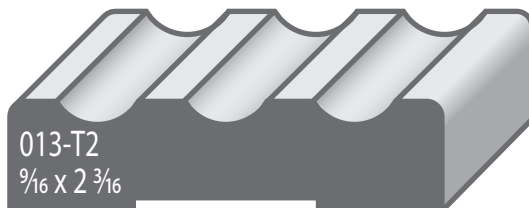
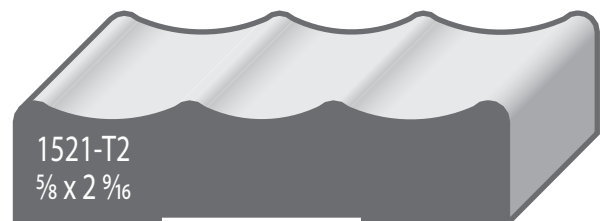
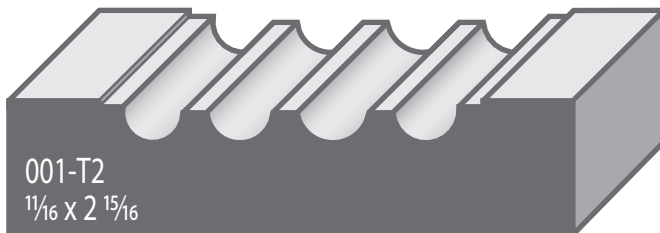
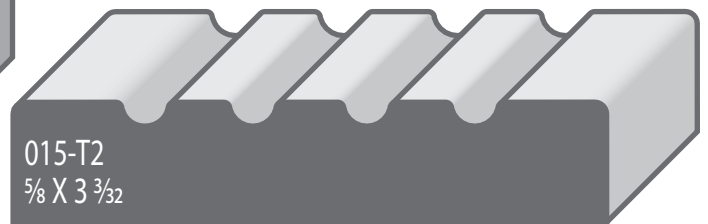
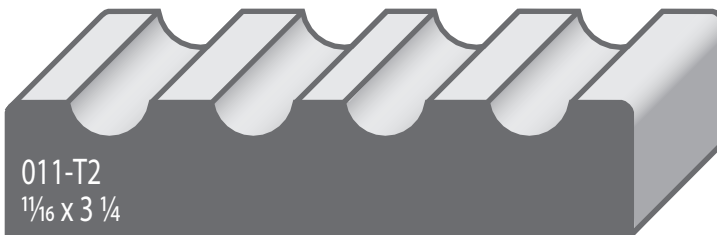
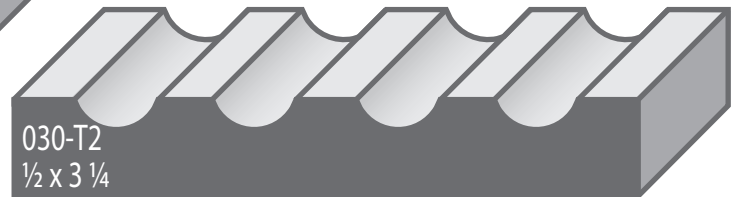
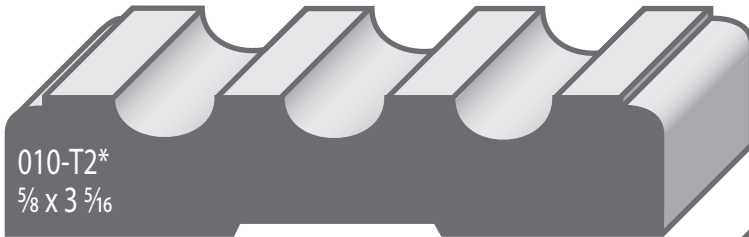
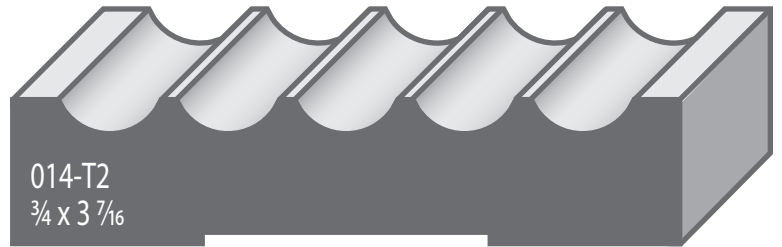
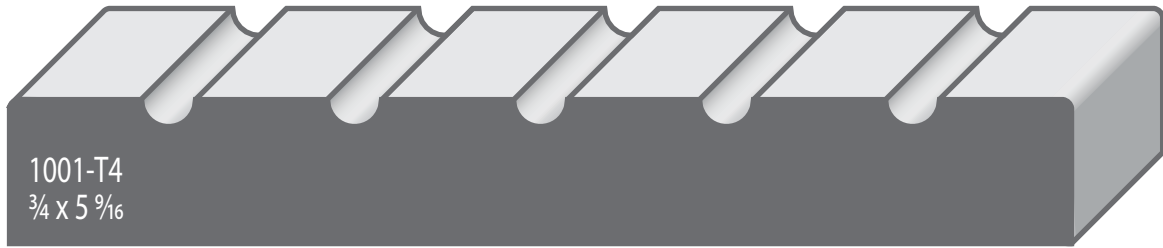

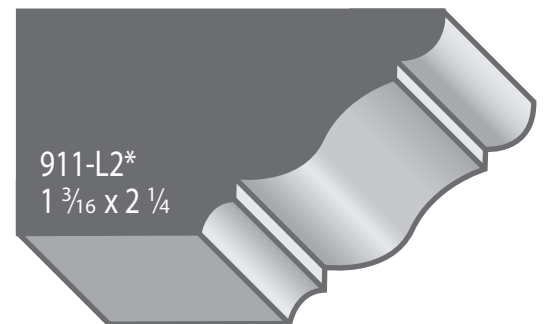
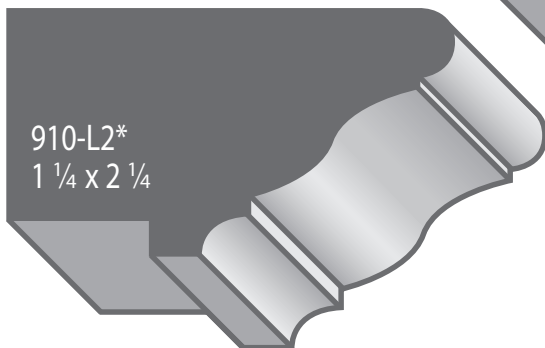
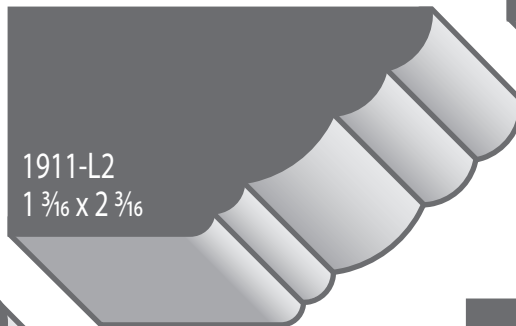
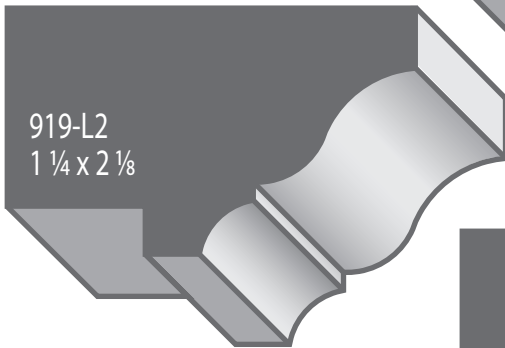
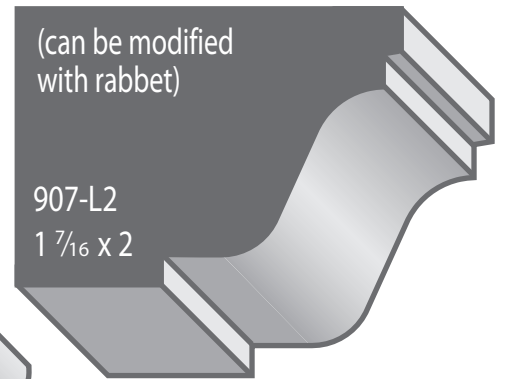
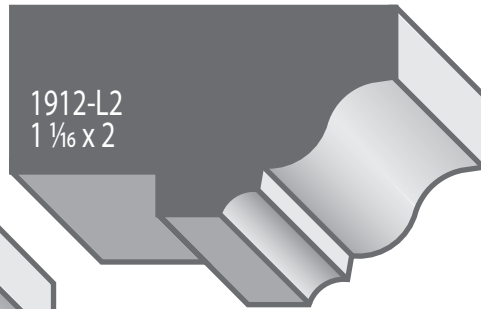
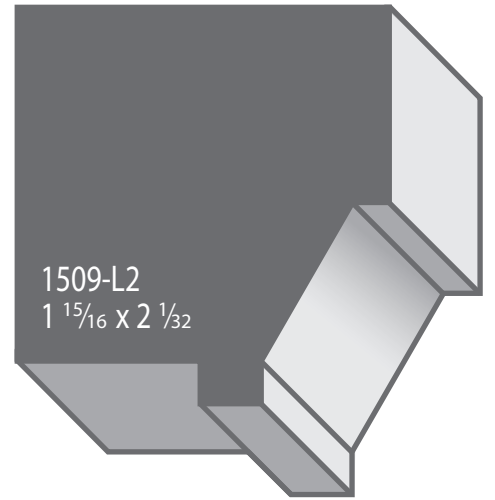
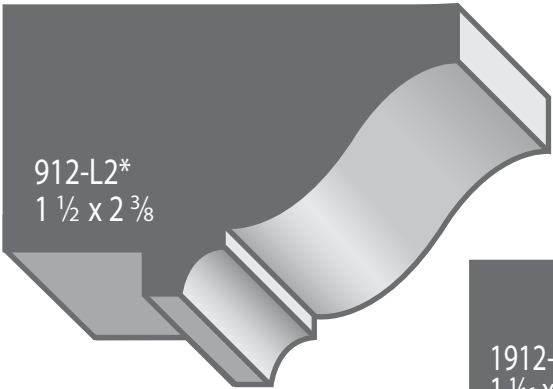
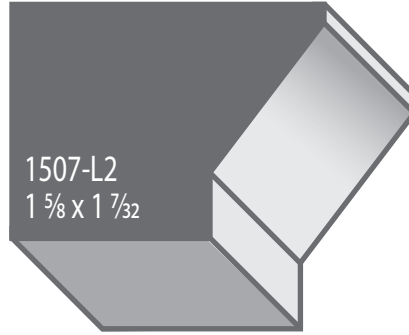
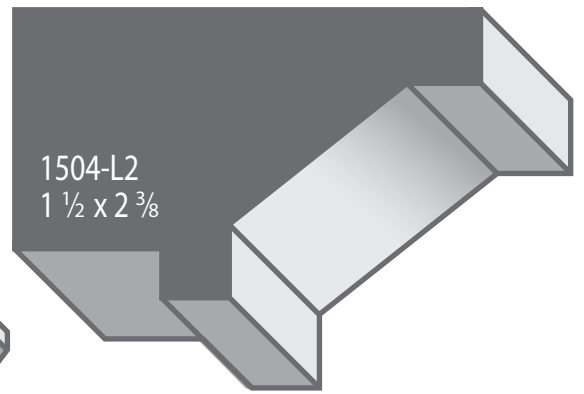
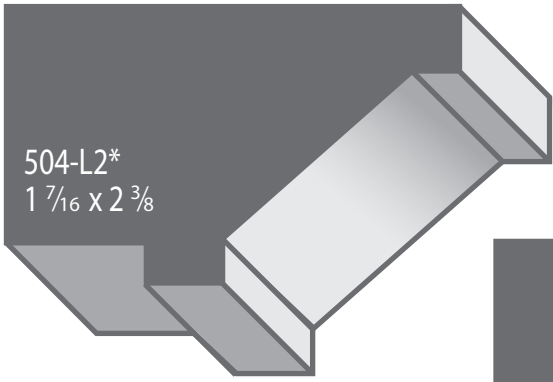



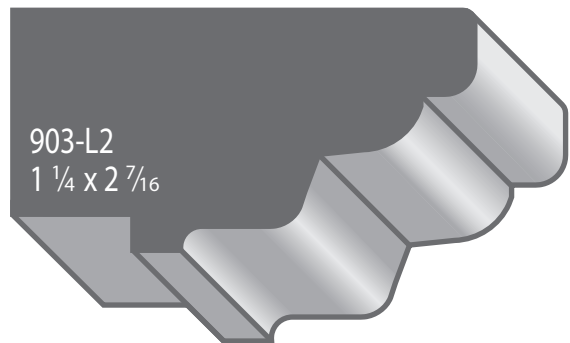
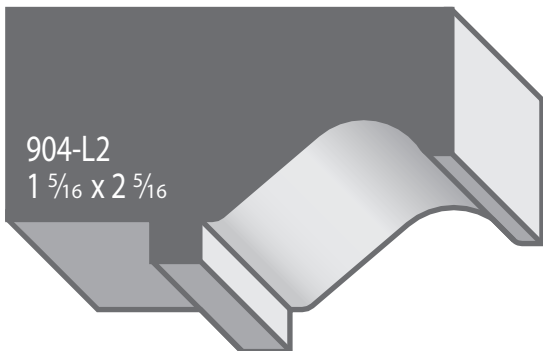
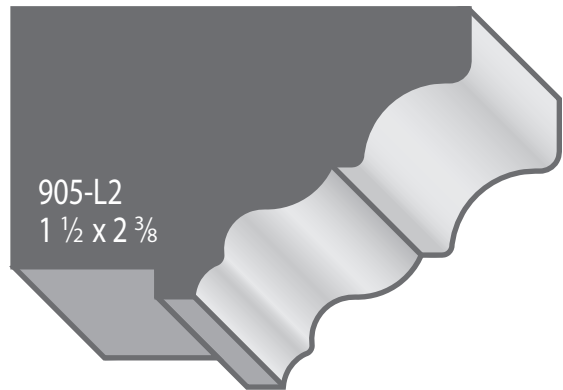
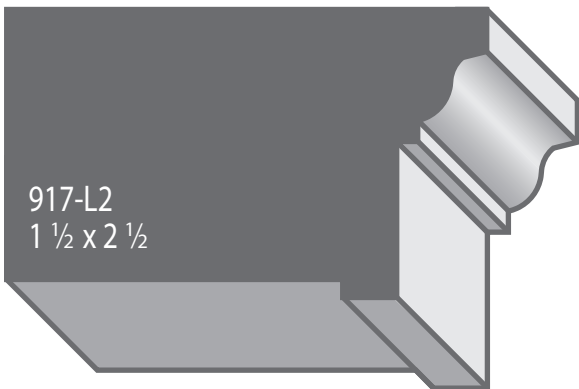
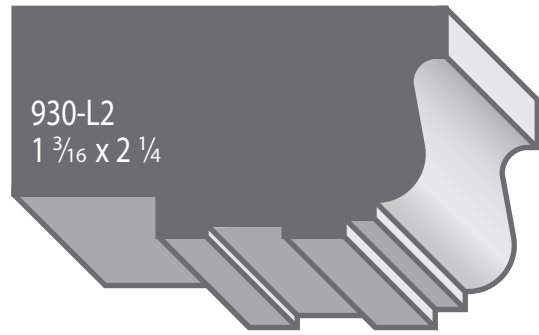
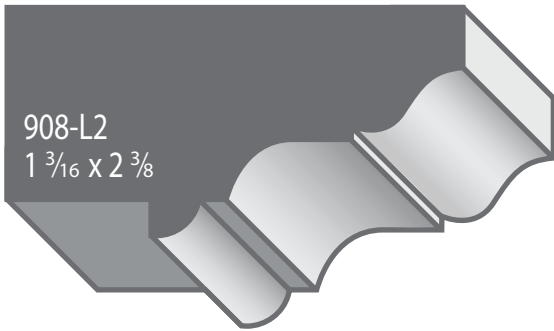
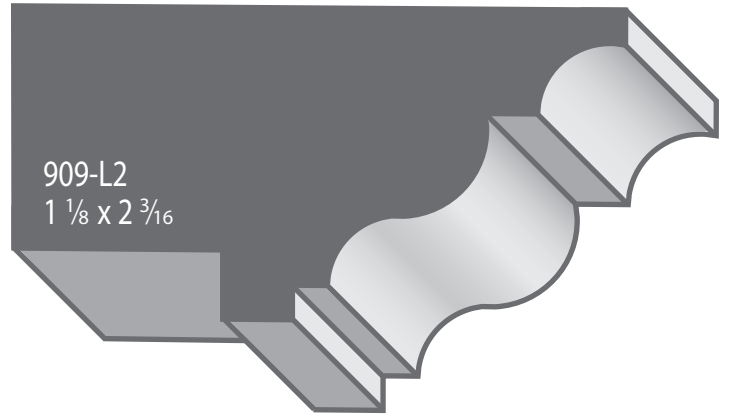
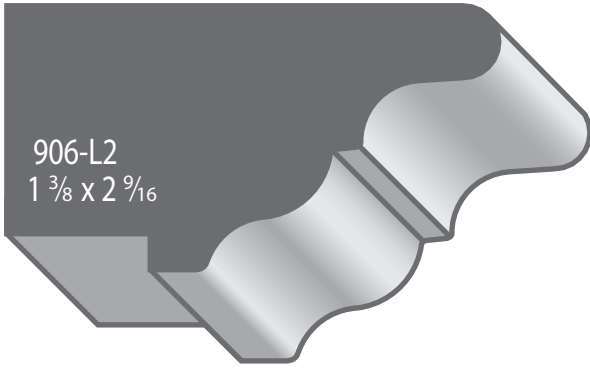
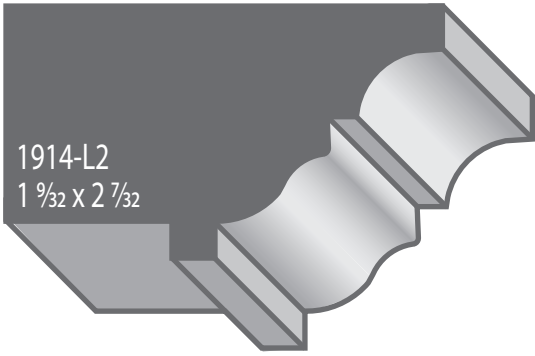

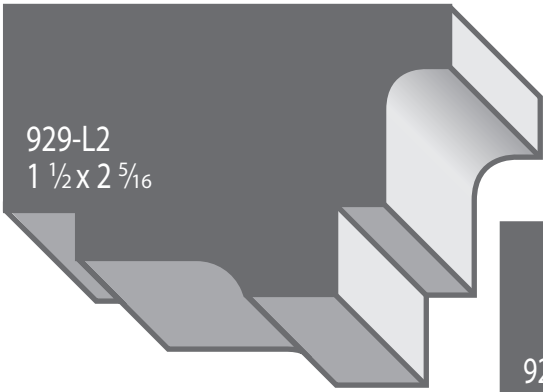

929-L2  
1 1/2 x 2 5/16

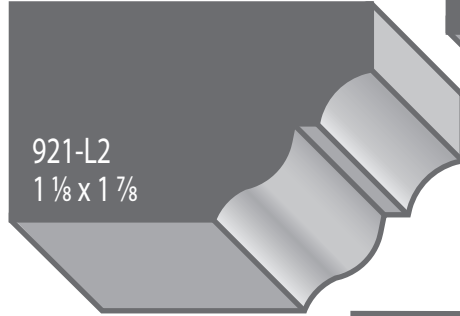

921-L2  
1 1/8 x 1 7/8

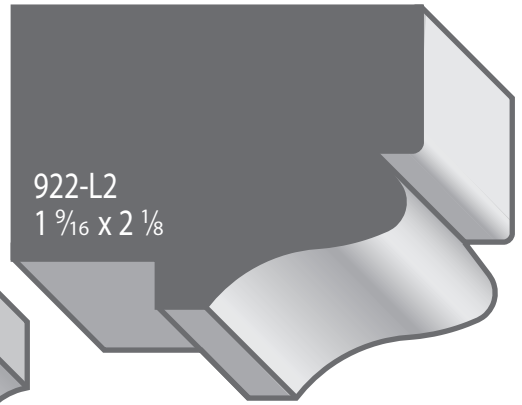

922-L2  
1 9/16 x 2 1/8

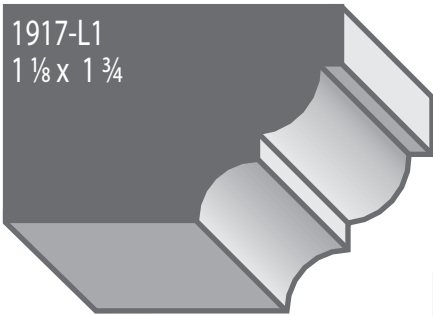

1917-L1  
1 1/8 x 1 3/4

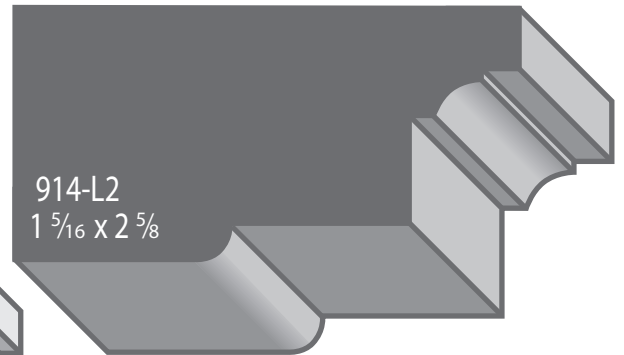

914-L2  
1 5/16 x 2 5/8

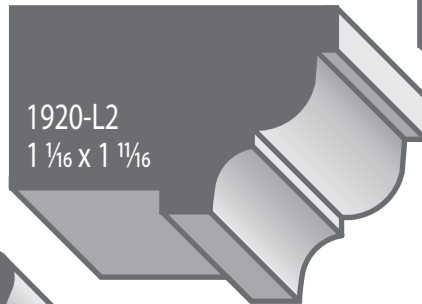

1920-L2  
1 1/16 x 1 11/16

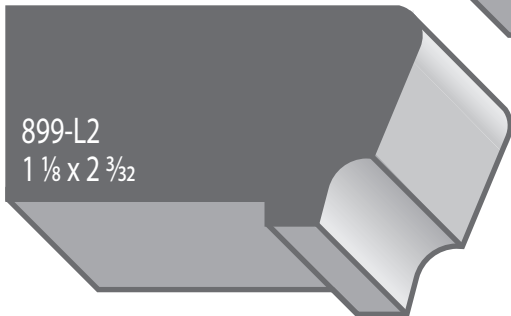

899-L2  
1 1/8 x 2 3/32

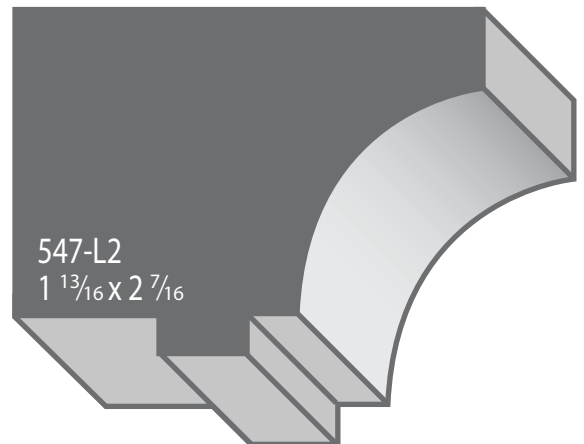

547-L2  
1 13/16 x 2 7/16

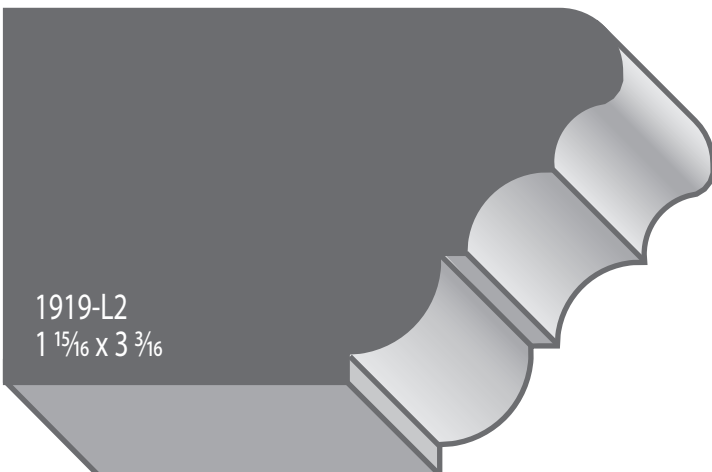

1919-L2  
1 15/16 x 3 3/16



916-L2  
1 3/4 x 2 1/4

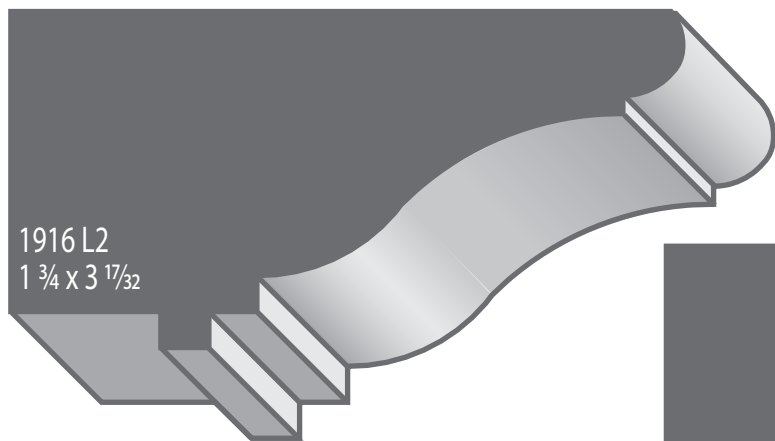

1916 L2  
1 3/4 x 3 17/32

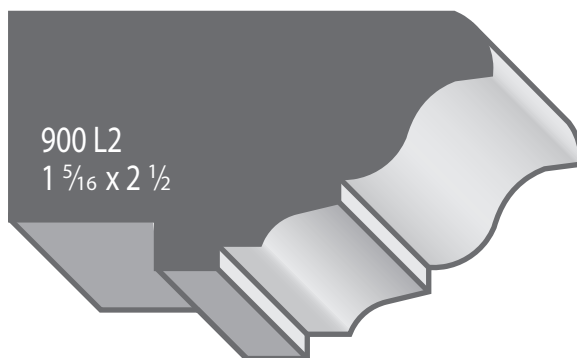

900 L2  
1 5/16 x 2 1/2

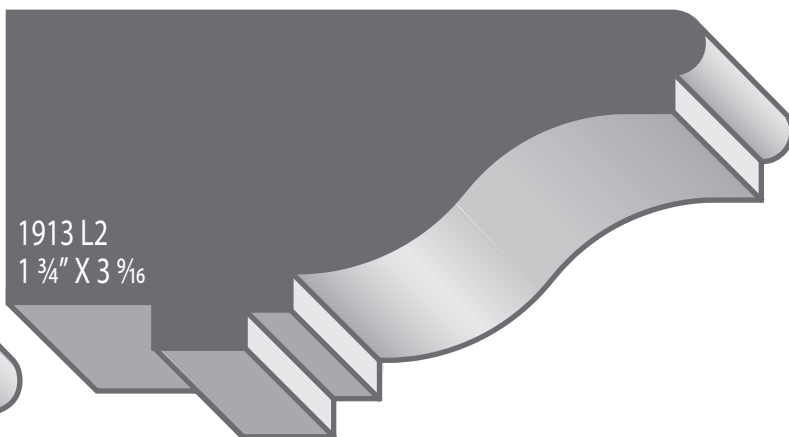

1913 L2  
1 3/4" X 3 5/16



913 L2  
1 1/2 x 3

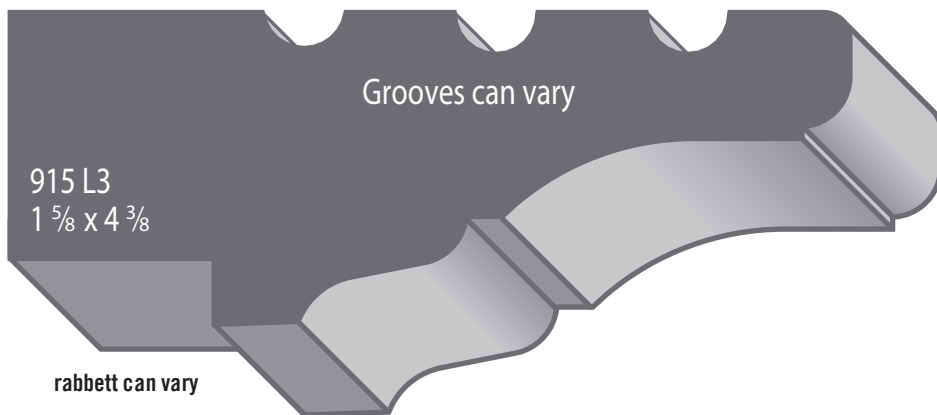

915 L3  
1 5/8 x 4 3/8

Grooves can vary

rabbet can vary

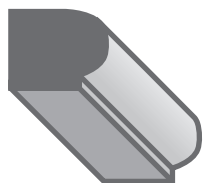

953B-S1  
1/2 x 3/8

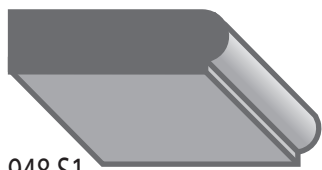

948 S1  
5/16 x 1 1/8



953 S1  
3/8 x 1 5/8



949 S1  
1/2 x 1 5/8



950 S1\*  
7/16 x 1 1/4



503 S1\*  
1/2 x 1 1/8



955 S1\*  
1/2 x 1 1/4



954 M1  
1 1/16 x 1 1/2



956 S1  
3/8 x 1 1/8

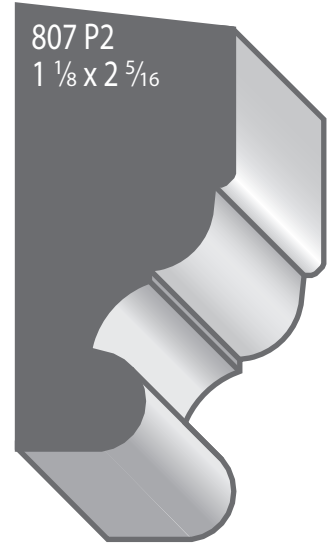

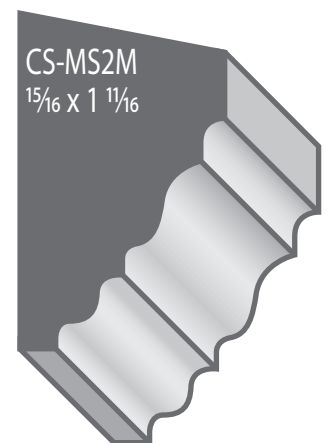
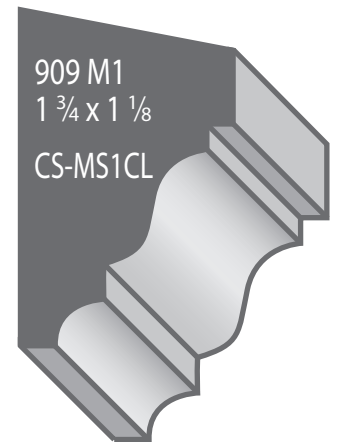
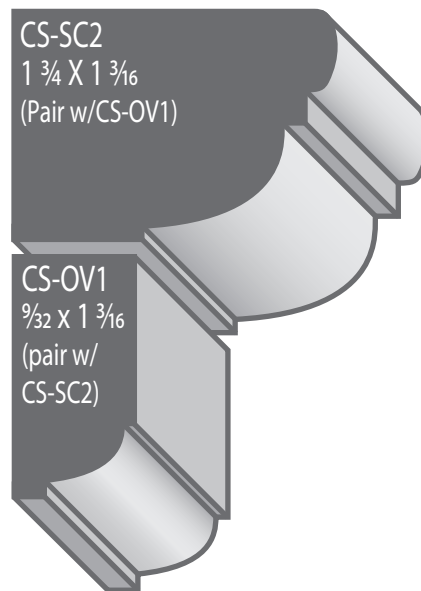
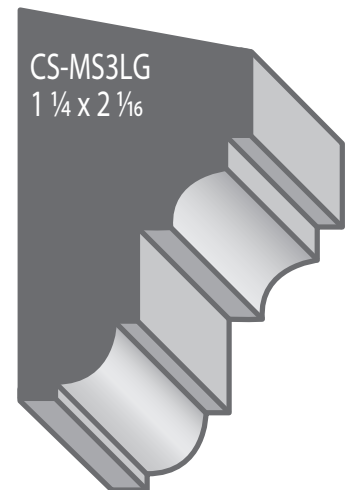
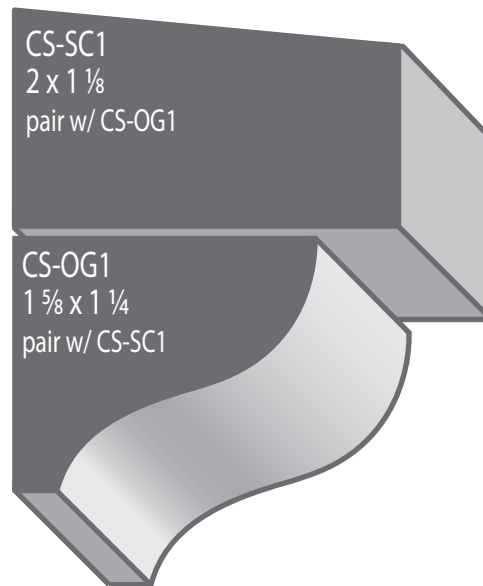
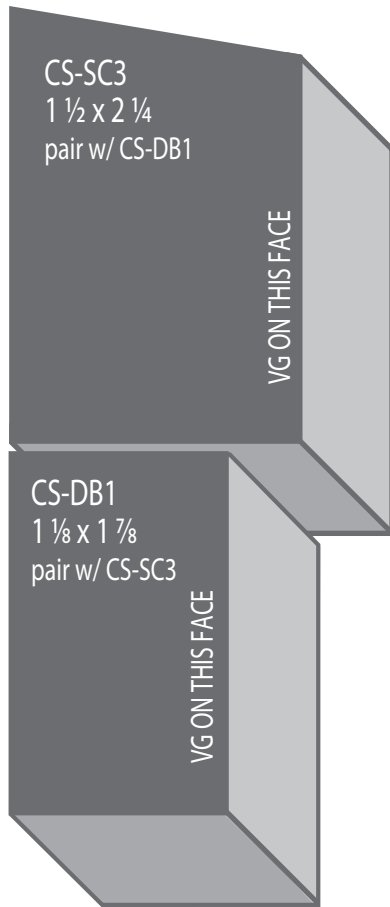

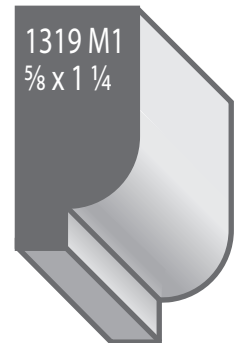
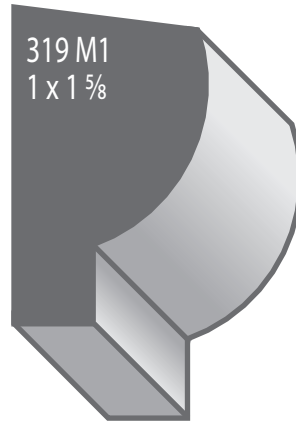
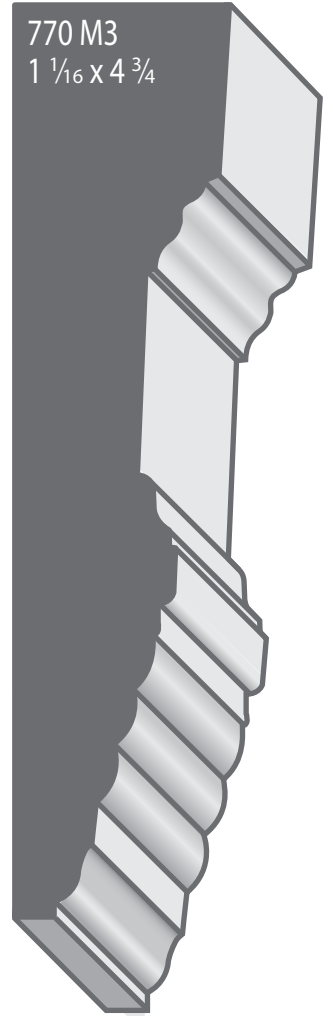
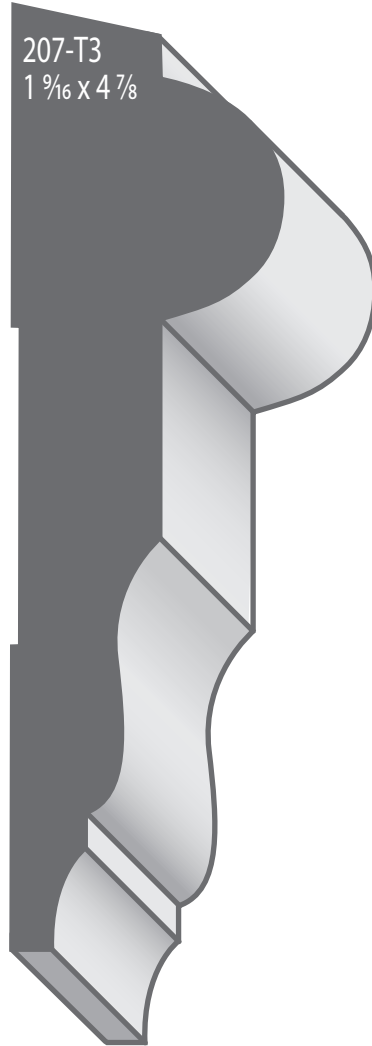
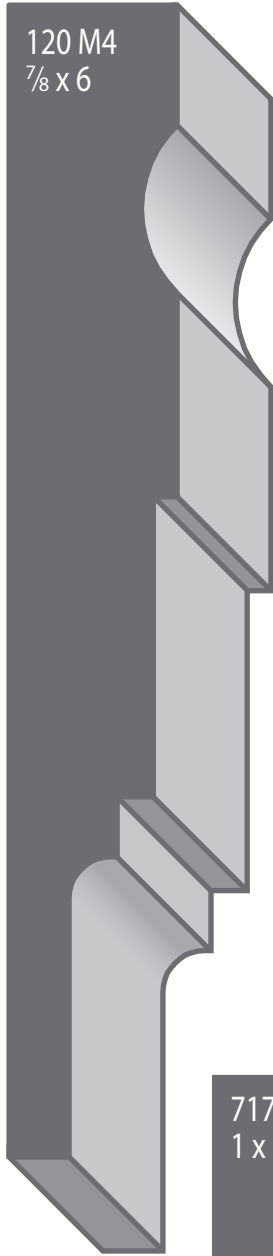

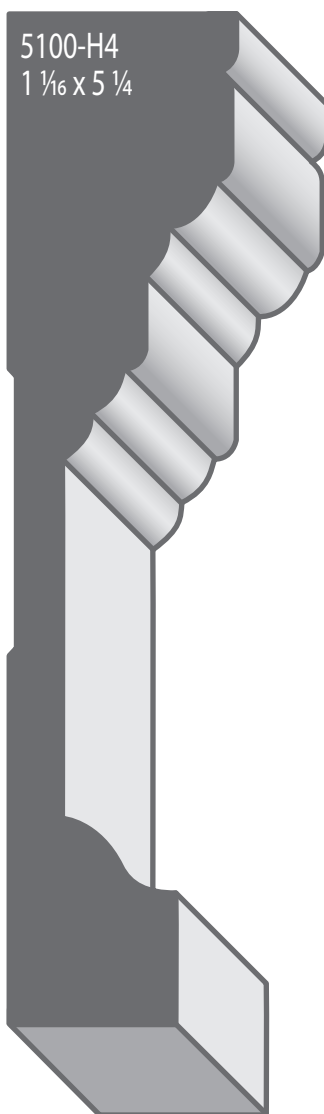
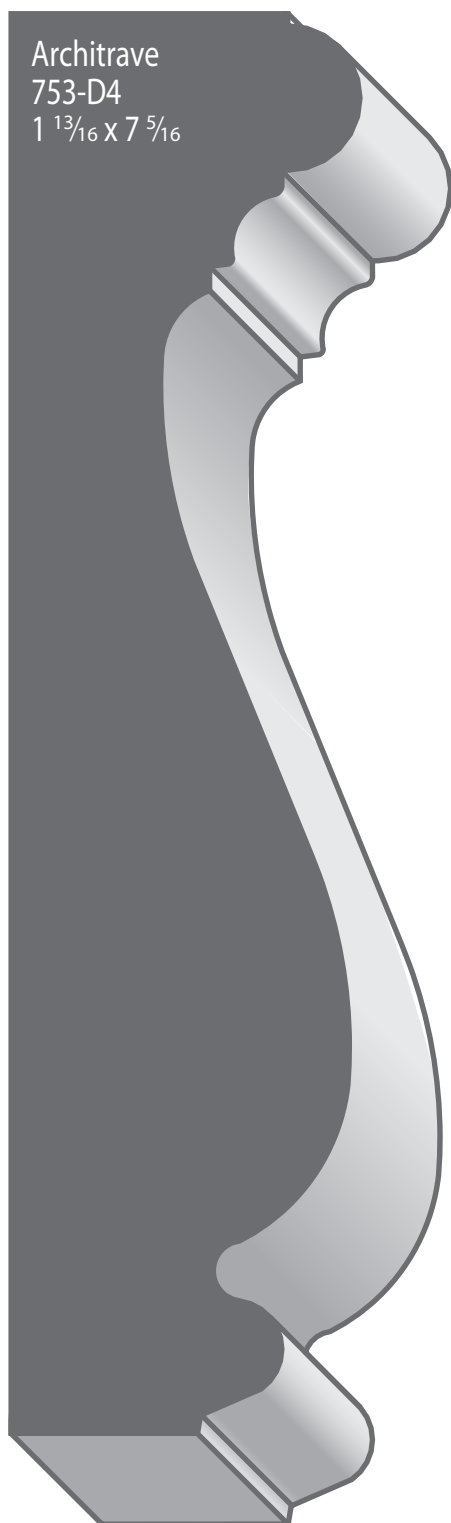

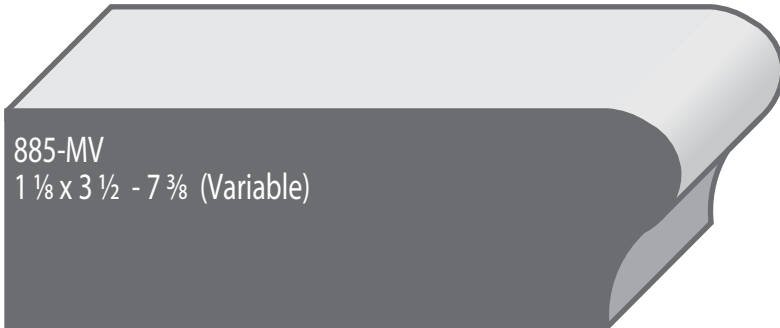
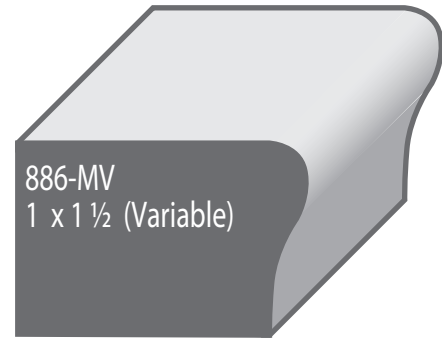
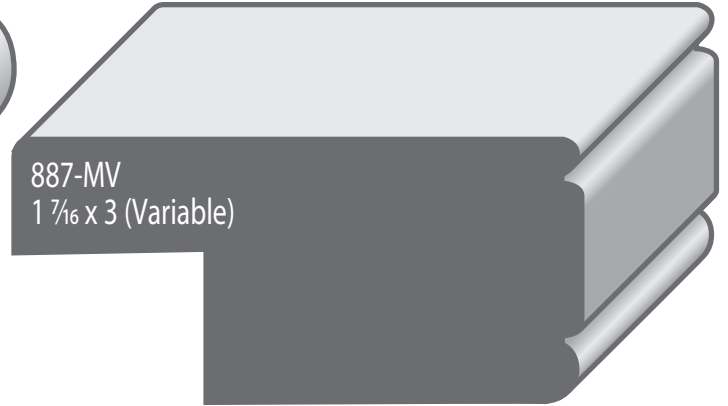





422 S1  
 $\frac{3}{4} \times 1 \frac{11}{16}$

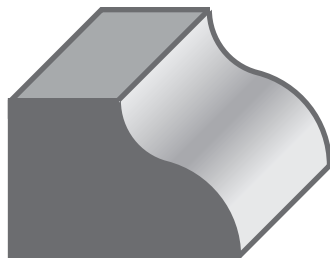

423 S1  
 $1 \frac{3}{16} \times 1 \frac{3}{16}$

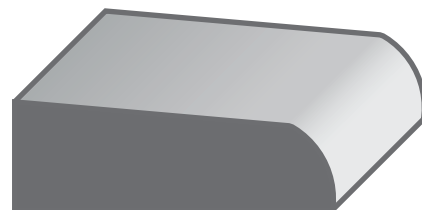

409 S1  
 $\frac{9}{16} \times 1 \frac{11}{16}$



415 S1  
 $\frac{1}{2} \times 1 \frac{1}{2}$

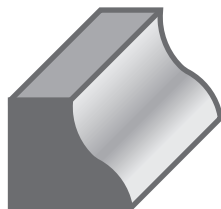

419 S1  
 $\frac{9}{16} \times \frac{5}{8}$

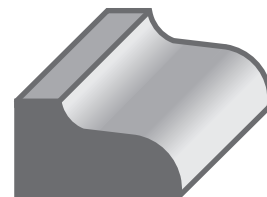

424 S1  
 $\frac{1}{2} \times \frac{7}{8}$



420 S1\*  
 $\frac{3}{8} \times 1 \frac{9}{16}$



417 S1\*  
 $\frac{3}{8} \times \frac{7}{8}$



1701-S1  
 $\frac{1}{2} \times 1 \frac{25}{32}$

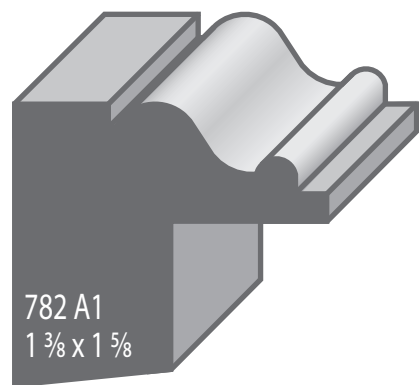

782 A1  
 $1 \frac{3}{8} \times 1 \frac{5}{8}$

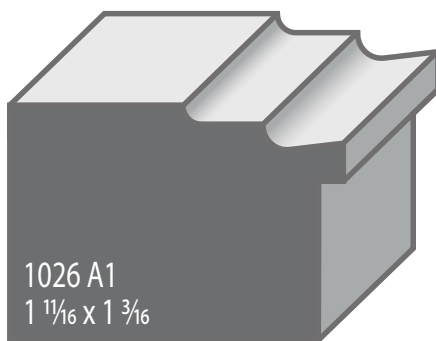

1026 A1  
 $1 \frac{11}{16} \times 1 \frac{3}{16}$

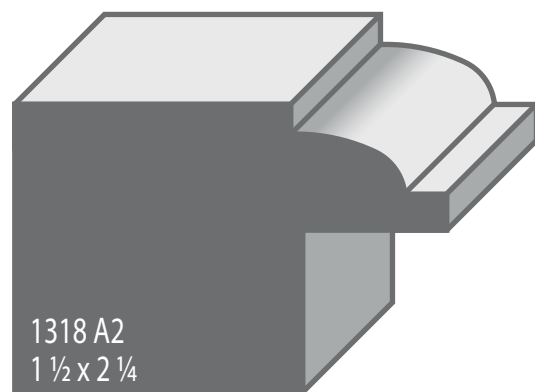

1318 A2  
 $1 \frac{1}{2} \times 2 \frac{1}{4}$

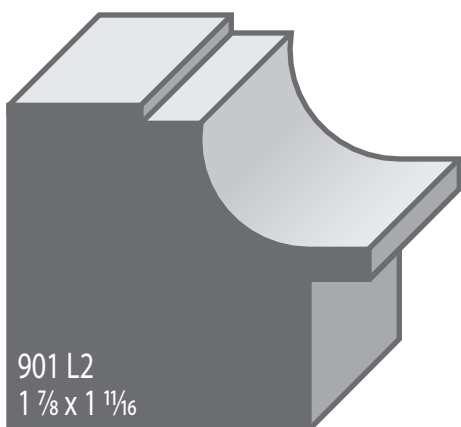

901 L2  
 $1 \frac{7}{8} \times 1 \frac{11}{16}$

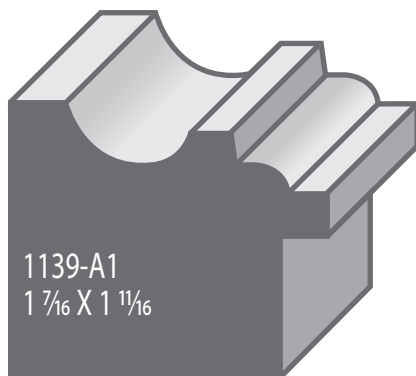

1139-A1  
 $1 \frac{7}{16} \times 1 \frac{11}{16}$

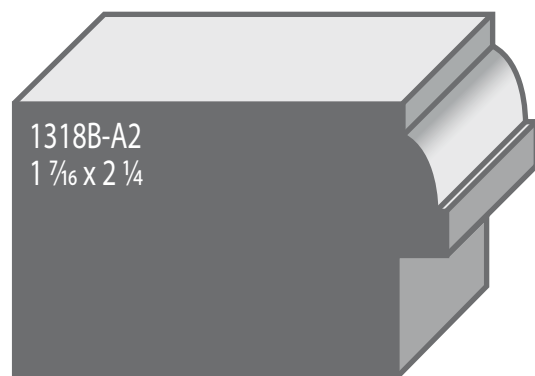

1318B-A2  
 $1 \frac{7}{16} \times 2 \frac{1}{4}$

