

Section B - Casings

McCOY MILLWORK

Custom Shop Services

For custom profiles pricing is determined by the chosen species of wood and quantity. Provide the following:

1. A sample or scale drawing of the profile.
2. Amount of moulding needed in Lineal Feet.
3. Preferred species of wood.
4. Preferred final finish (paint or stain).

Send us your information via email or come in for a quote. You can expect to hear from us regarding pricing in 2 days.

Manufacturing time varies: 2 days-2 weeks.

| Profile # | Pg # | Profile # | Pg # | Profile # | Pg # | Profile # | Pg # |
|----------------------------|------|-------------------------|--------|----------------------------|------|--------------------------|------|
| 001-T2 Fluted Casing | 74 | 120-T2 Casing | 60 | 170C-T2 Casing | 46 | 264-T2 Casing | 61 |
| 010-T2* Fluted Casing | 74 | 121-T2 Casing | 58 | 170-T2 Casing | 46 | 265-T2* Clamshell Casing | 65 |
| 011-T2 Fluted Casing | 74 | 122-T2 Casing | 61 | 171B-T2 Center Bead Casing | 42 | 266-T2 Casing | 61 |
| 012-T2 Fluted Casing | 74 | 130-T2* Casing | 64 | 171-T2 Center Bead Casing | 42 | 268B-T2 Clamshell Casing | 65 |
| 013-T2 Fluted Casing | 74 | 131-T2* Sanitary Casing | 64 | 172-T2 Casing | 60 | 268-T2 Clamshell Casing | 65 |
| 014-T2 Fluted Casing | 74 | 133-T2 Casing | 64 | 173B-T2 Center Bead Casing | 41 | 269-M2 Apron | 79 |
| 015-T2 Fluted Casing | 74 | 134-T2* Casing | 58 | 173-T2 Casing | 41 | 304-A2 Backband | 84 |
| 021-T2 Reeded Casing | 73 | 137-T2 Casing | 63 | 174B-T2 Casing | 58 | 319-M1 Apron | 80 |
| 022-T2 Casing | 61 | 138-T4 Casing | 52 | 174-T2 Center Bead Casing | 42 | 355-T2 Casing | 47 |
| 023-T4 Sym Casing | 66 | 139-T2 Casing | 61 | 175-T2 Casing | 60 | 356-T2* Casing | 47 |
| 024-T4 Sym Casing | 67 | 140-T2* Casing | 44 | 176-T2 Casing | 57 | 357-T2 Casing | 47 |
| 025-T2 Reeded Casing | 73 | 141-T2 Casing | 44, 63 | 177B-T3 Casing | 53 | 358B-T2 Col Casing | 47 |
| 026-T1 Reeded Casing | 73 | 142-T2 Casing | 63 | 177-T3 Casing | 55 | 358-T2 Casing | 47 |
| 027-T2 Reeded Casing | 73 | 143-T2 Casing | 44 | 178-T2 Casing | 71 | 359-T2 Casing | 47 |
| 028-T2 Sym Casing | 73 | 144-T2 Casing | 63 | 178-T3 Symm Casing | 70 | 384-BV Apron | 79 |
| 029-T2 Symmetrical Casing | 71 | 145-T3 Casing | 58 | 179-T3 Sym Casing | 68 | 386-T3 Casing | 53 |
| 030-T2 Fluted Casing | 74 | 148-T2 Casing | 56 | 180-T4* Sym Casing | 67 | 387-MV Casing | 59 |
| 031-T3 Symm Casing | 70 | 149B-T2 Casing | 59 | 181B-T4 Casing | 66 | 387-T2 Casing | 59 |
| 100-T1* Sym Casing | 72 | 149-T2 Casing | 58 | 181-D4 Sym Casing | 67 | 388B-T2 Casing | 49 |
| 107-T1 Casing | 64 | 150B-T2 Casing | 43 | 181-T4 Sym Casing | 68 | 388C-T2 Casing | 49 |
| 108-T1 Casing | 64 | 150C-T2 Casing | 43 | 183-T3 Sym Casing | 68 | 388D-T2 Casing | 49 |
| 109-T1 Casing | 64 | 150-T2* Casing | 44 | 185B-T2 Sym Casing | 62 | 388-T2 Casing | 49 |
| 110-T1* Casing | 64 | 151-T3 Casing | 52 | 185-T2* Casing | 59 | 390-T2 Casing | 49 |
| 111B-T2 Center Bead Casing | 41 | 152-T3 Casing | 52 | 187-D2 Symm Casing | 71 | 391-T1 Casing | 63 |
| 111C-T2 Center Bead Casing | 42 | 153-M2 Apron | 79 | 191-T2 Casing | 48 | 392.2-T2 Step Casing | 49 |
| 111-T2* Center Bead Casing | 42 | 153-T3 Casing | 51 | 193-T2 Casing | 62 | 392-T2 Step Casing | 49 |
| 112-T1* Casing | 63 | 155-T3* Casing | 54 | 194-T2 Casing | 48 | 409-S1 Stop | 83 |
| 113B-T3 Casing | 48 | 156-T2 Casing | 43 | 196-T2 Casing | 48 | 410-T2 Casing | 62 |
| 113-T2* Casing | 48 | 158B-T3 Casing | 54 | 207-T3 Apron/Casing | 80 | 411-T2* Casing | 60 |
| 114-BV Casing | 50 | 158-T2 Casing | 56 | 245-T2 Casing | 60 | 413-T2 Casing | 59 |
| 115-T2* Colonial casing | 47 | 158-T3 Casing | 51 | 248-P2 Casing | 63 | 415-S1 Stop | 83 |
| 116-T2 Casing | 57 | 158-T4 Casing | 50 | 261-T1 Clamshell Casing | 65 | 416-T3 Casing | 52 |
| 117-T2 Casing | 61 | 159B-T3 Casing | 43 | 262-T1* Clamshell Casing | 65 | 417-S1* Stop | 83 |
| 118-T2 Casing | 60 | 159-T3 Casing | 43 | 263-T1 Clamshell Casing | 65 | 419-S1 Stop | 83 |
| 119-T3 Casing | 54 | 162-B2 Casing | 47 | 263-T2 Clamshell Casing | 65 | 420-S1* Stop | 83 |
| 120-M4 Apron | 80 | 170B-T2 Casing | 46 | 264B-T2 Casing | 62 | 421-S1 Stop | 83 |



| Profile # | Pg # | Profile # | Pg # | Profile # | Pg # | Profile # | Pg # |
|----------------------|------|-----------------------|------|-----------------------------|------|-----------------------------|------|
| 422-S1 Stop | 83 | 885-MV Sill | 83 | 1022-A1* Backband | 85 | 1152-T2 Casing | 57 |
| 423-S1 Stop | 83 | 886-MV Sill | 83 | 1024-A1 Backband | 85 | 1153-T2 Casing | 57 |
| 424-P2 Misc/Apron | 79 | 887-MV Sill | 83 | 1025-A1* Backband | 85 | 1154-T2 Casing | 56 |
| 424-S1 Stop | 83 | 888-MV* Sill | 83 | 1026-A1 Backband | 84 | 1156-T2 Casing | 58 |
| 427-P2 Apron | 79 | 889-MV Sill | 83 | 1027-A1 Backband | 85 | 1157-T2 Casing | 56 |
| 436-P1 Apron | 79 | 894-D2 Sym Casing | 71 | 1028-P2 Backband | 85 | 1158-T2 Casing | 56 |
| 444-T2* Casing | 47 | 899-L2 Lintel | 77 | 1029-A1* Backband | 85 | 1159-T2 Casing | 58 |
| 447-T2 Casing | 47 | 900-L2 Lintel | 78 | 1039-T2 Casing | 63 | 1170B-T2 Center Bead Casing | 42 |
| 448-T2 Casing | 47 | 901-L2 Backband | 84 | 1104-T2 Casing | 63 | 1170-T2 Center Bead Casing | 42 |
| 487-T2 Casing | 60 | 902-L2 Lintel | 76 | 1105-T2 Casing | 63 | 1171-T2 Center Bead Casing | 42 |
| 488-T2 Casing | 49 | 903-L2 Lintel | 76 | 1111B-T2 Center Bead Casing | 41 | 1172-T2 Center Bead Casing | 42 |
| 496-T3 Casing | 52 | 904-L2 Lintel | 76 | 1111-T2 Center Bead Casing | 41 | 1173B-T2 Center Bead Casing | 42 |
| 503-S1* Parting Bead | 78 | 905-L2 Lintel | 76 | 1113-T2 Casing | 48 | 1173-T2 Center Bead Casing | 42 |
| 504-L2* Lintel | 75 | 906-L2 Lintel | 76 | 1114-T3 Casing | 48 | 1174-T2 Casing | 62 |
| 525-T4 Symm Casing | 67 | 907-L2 Lintel | 75 | 1117-T2 Reeded Casing | 73 | 1175-T2 Center Bead Casing | 42 |
| 528-PV Apron | 79 | 908-L2 Lintel | 76 | 1118-T2 Casing | 44 | 1176-T2 Center Bead Casing | 41 |
| 529-T2 Sym Casing | 71 | 909-L2 Lintel | 76 | 1120-T2 Casing | 63 | 1177-T2 Center Bead Casing | 41 |
| 530-T2 Symm Casing | 72 | 909-M1 Apron | 81 | 1121-T2 Casing | 59 | 1181-T4 Sym Casing | 66 |
| 533B-T2 Casing | 44 | 910-L2* Lintel | 75 | 1122-T2 Casing | 60 | 1182-T4 Sym Casing | 67 |
| 533-T2 Casing | 44 | 911-L2* Lintel | 75 | 1123-A1 Backband | 85 | 1183B-T4 Sym Casing | 67 |
| 534-T2 Casing | 59 | 912-L2* Lintel | 75 | 1123-T2 Casing | 60 | 1183-T3 Sym Casing | 69 |
| 534-T3 Casing | 53 | 913-L2 Lintel | 78 | 1124-T2 Casing | 57 | 1183-T4 Sym Casing | 68 |
| 535-T2* Casing | 57 | 914-L2 Lintel | 77 | 1125-A1 Backband | 85 | 1184-T3 Sym Casing | 69 |
| 536-T3 Casing | 53 | 915-L3 Lintel | 78 | 1126-A1 Backband | 84 | 1188-T4 Sym Casing | 66 |
| 547-L2 Lintel | 77 | 916-L2 Lintel | 77 | 1127-A1 Backband | 85 | 1193-T2 Casing | 61 |
| 620-T2 Casing | 61 | 917-L2 Lintel | 76 | 1128-A1 Backband | 85 | 1203-T2 Casing | 63 |
| 717-D2 Apron | 58 | 919-L2 Lintel | 75 | 1129-A1 Backband | 85 | 1211-T4 Casing | 50 |
| 726-P2 Apron | 79 | 921-L2 Lintel | 77 | 1130-T2 Casing | 64 | 1212-T4 Casing | 50 |
| 746-P2 Casing/Apron | 61 | 922-L2 Lintel | 77 | 1131-T1 Casing | 64 | 1213-T3 Casing | 53 |
| 750-T2 Casing | 60 | 929-L2 Lintel | 77 | 1132-T2 Sanitary Casing | 64 | 1214-T4 Casing | 50 |
| 751-MV Apron | 79 | 930-L2 Lintel | 76 | 1133-T2 San Casing | 64 | 1261-T1 Clamshell Casing | 65 |
| 753-D4 Architrave | 82 | 931-M2 Apron | 80 | 1136-A1 Backband | 84 | 1262-T1 Clamshell Casing | 65 |
| 755-T2 Casing | 60 | 948-S1 Bead | 78 | 1137-T4 Casing | 43 | 1264-T2 Clamshell Casing | 65 |
| 756-T2 Casing | 55 | 949-S1 Bead | 78 | 1138-T3 Casing | 52 | 1266-T2 Casing | 63 |
| 757-T4 Casing | 50 | 950-S1* Parting Bead | 78 | 1139B-TV Casing | 57 | 1270-T2 Casing | 46 |
| 758-T3 Casing | 52 | 953-S1 Bead | 78 | 1139T2 Casing | 56 | 1316-T3 Casing | 53 |
| 770-M3 Apron | 80 | 954-M1 Bead | 78 | 1139-T3 Casing | 51 | 1318-A2 Backband | 84 |
| 772-M4 Apron | 80 | 955-S1* Parting Bead | 78 | 1140-T2 Casing | 44 | 1318B-A2-1 Backband | 84 |
| 781-P2 Casing | 61 | 956-S1 Parting Bead | 78 | 1141-T2 Casing | 63 | 1318B-A2 Backband | 84 |
| 782-A1 Backband | 84 | 957-S1* Parting Bead | 78 | 1142-T2 Casing | 62 | 1319-M1 Apron | 80 |
| 803-T2 Symm Casing | 72 | 984-A1 Backband | 85 | 1143-T2 Casing | 62 | 1381-T3 Casing | 55 |
| 804-T3 Sym Casing | 70 | 985-A1 Backband | 85 | 1145-T2 Casing | 60 | 1384-T2 Casing | 49 |
| 806-T2 Casing | 62 | 990-A1 Backband | 85 | 1146-T2 Casing | 61 | 1438-T2 Colonial Casing | 47 |
| 807-P2 Apron | 79 | 994-T2 Casing | 58 | 1148-T2 Casing | 62 | 1439-T2 Colonial Casing | 47 |
| 808-T2 Casing | 63 | 1001-T4 Fluted Casing | 74 | 1149-T2 Casing | 62 | 1444-T3 Casing | 47 |
| 820-T2 Symm Casing | 72 | 1020-A1 Backband | 85 | 1150-T2 Casing | 43 | 1461-T2 Casing | 59 |
| 821-T2 Casing | 57 | 1021-A1* Backband | 85 | 1151-T2 Casing | 43 | 1462-T2 Casing | 59 |



| Profile # | Pg # | Profile # | Pg # | Profile # | Pg # | Profile # | Pg # |
|----------------------------|------|----------------------------|------|-----------|------|-----------|------|
| 1463-T2 Casing | 46 | 2175-T2 Casing | 55 | | | | |
| 1464-T2 Apron/Misc | 79 | 2178-T3 Sym Casing | 71 | | | | |
| 1467-T2 Casing | 59 | 2178-T4 Symm Casing | 68 | | | | |
| 1504-L2 Lintel | 75 | 2180-C4 Sym Casing | 66 | | | | |
| 1507-L2 Lintel | 75 | 2182-T3 Symm Casing | 69 | | | | |
| 1509-L2 Lintel | 75 | 2186-T4 Symm casing | 69 | | | | |
| 1521-T2 Sym Casing | 74 | 2190-C2 Casing | 62 | | | | |
| 1523-T2 Sym Casing | 71 | 2190-T2 Casing | 62 | | | | |
| 1524-T2 Reeded Casing | 73 | 2249-M2 Apron | 79 | | | | |
| 1526-T2 Symm Casing | 71 | 2264-T2 Casing | 65 | | | | |
| 1527-T3 Sym Casing | 66 | 2296-D2 Casing | 62 | | | | |
| 1528-T4 Sym Casing | 66 | 2316-T3 Casing | 53 | | | | |
| 1529-T4 Sym Casing | 66 | 2384-T2 Step Casing | 49 | | | | |
| 1530-T2 Casing | 56 | 2388-T2 Step Casing | 49 | | | | |
| 1531B-T4 Sym Casing | 70 | 2390-B3 Casing/Base | 54 | | | | |
| 1531-T4 Sym Casing | 68 | 2420-SV Stop | 83 | | | | |
| 1532-T3 Sym Casing | 70 | 2421-S1 Stop | 83 | | | | |
| 1560-T3 Casing | 54 | 2444-T2 Casing | 47 | | | | |
| 1561-T2 Casing | 55 | 2448-T2 Casing | 59 | | | | |
| 1570-T3 Sym Casing | 69 | 2449-T2 Casing | 59 | | | | |
| 1580-T4 Casing | 51 | 2472-T1 Casing | 63 | | | | |
| 1701-S1 Stop | 83 | 2509-L2 Lintel | 84 | | | | |
| 1720-T3 Symm Casing | 69 | 2528-T2 Casing | 61 | | | | |
| 1804-T2 Casing | 63 | 2534-T2 Casing | 44 | | | | |
| 1911-L2 Lintel | 75 | 2536-T2 Apron | 79 | | | | |
| 1912-L2 Lintel | 75 | 2746-T2 Casing/Apron | 62 | | | | |
| 1913-L2 Lintel | 78 | 2815-T2 Symmetrical Casing | 71 | | | | |
| 1914-L2 Lintel | 76 | 2833-T2 Step Casing | 49 | | | | |
| 1916-L2 Lintel | 78 | 3120-T2 Casing | 55 | | | | |
| 1917B-L1 Lintel | 77 | 3121-T3 Casing | 54 | | | | |
| 1917-L1 Lintel | 77 | 3122-T2* Casing | 45 | | | | |
| 1919-L2 Lintel | 77 | 3123-T3 Casing | 51 | | | | |
| 1920-L2 Lintel | 78 | 3131-T2 Casing | 46 | | | | |
| 1922-A1 Backband | 85 | 3133-T2 Casing | 57 | | | | |
| 2001-T2 Symm Casing | 73 | 3134B-T2 Casing | 45 | | | | |
| 2020-T2 Symm Casing | 71 | 3134B-T4 Casing | 45 | | | | |
| 2021-T2 Reeded Casing | 73 | 3134-T4 Casing | 45 | | | | |
| 2025-T2 Reeded Casing | 73 | 3135-T3 Casing | 54 | | | | |
| 2027-A1 Backband | 85 | 3136-T4 Casing | 51 | | | | |
| 2111-T2 Center Bead Casing | 41 | 3137-T4 Casing | 55 | | | | |
| 2116-T2 Casing | 56 | 3138-T3 Casing | 45 | | | | |
| 2130-T2 Casing | 64 | 5100B-H4 Architrave | 82 | | | | |
| 2138-T3 Casing | 45 | 5100-H4 Architrave | 82 | | | | |
| 2139-A0 Backband | 84 | 93041-A1 Backband | 85 | | | | |
| 2141-T2 Base | 61 | | | | | | |
| 2151-T2 Casing | 58 | | | | | | |
| 2156-T2 Symm Casing | 70 | | | | | | |

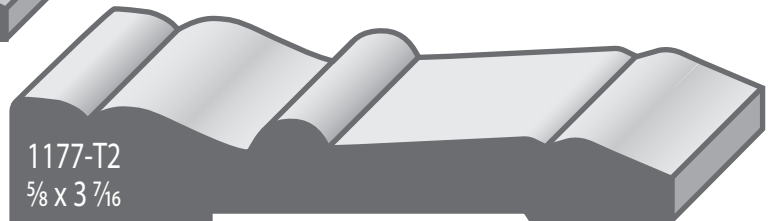
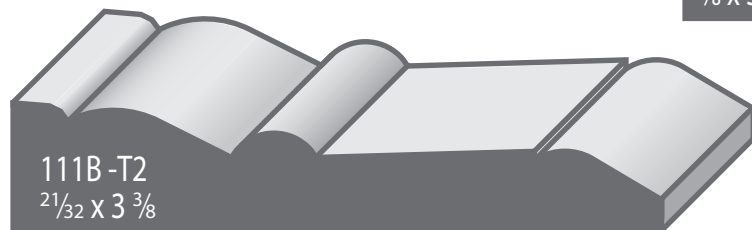
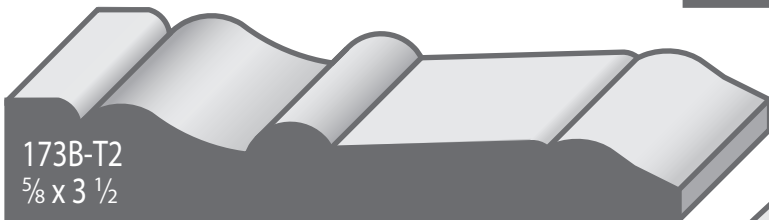
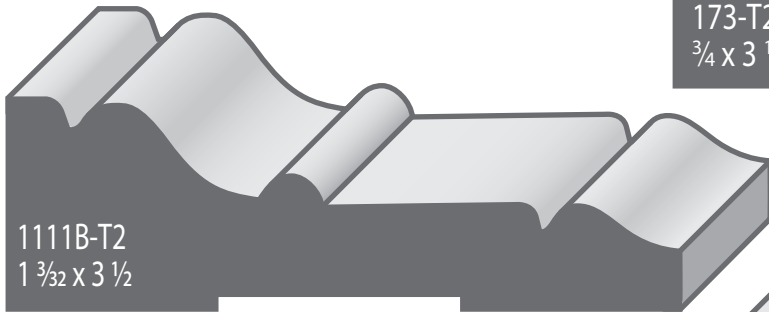
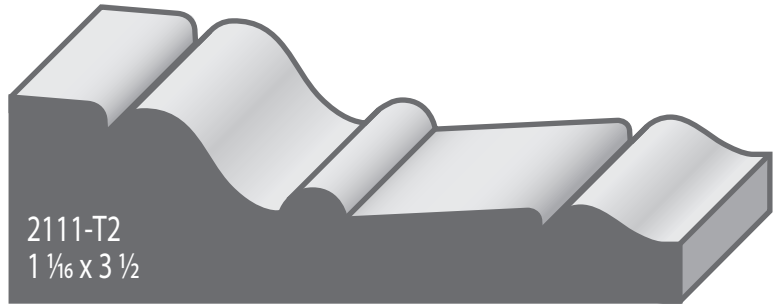
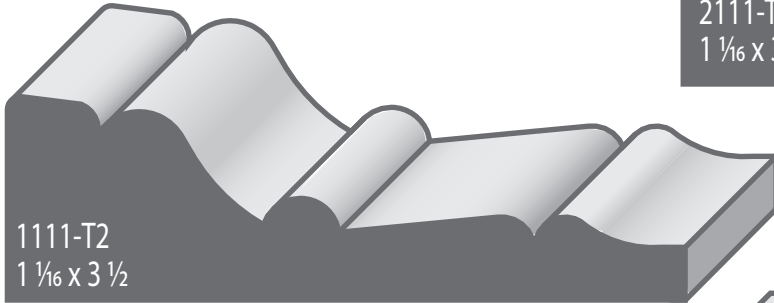

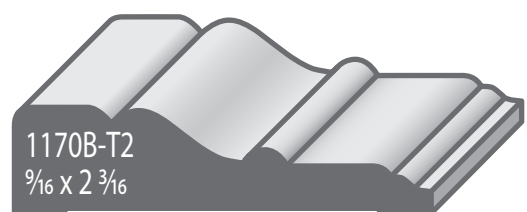
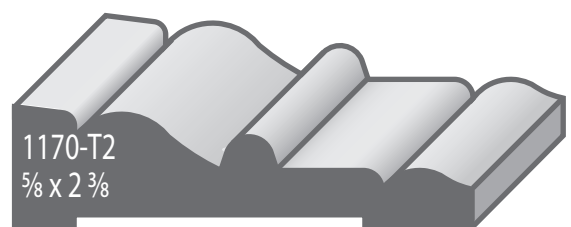
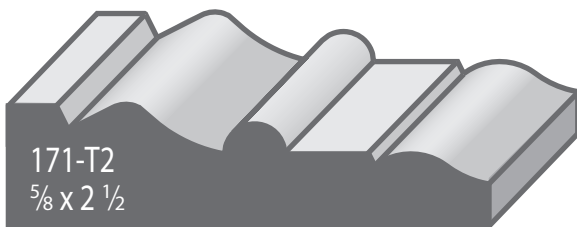
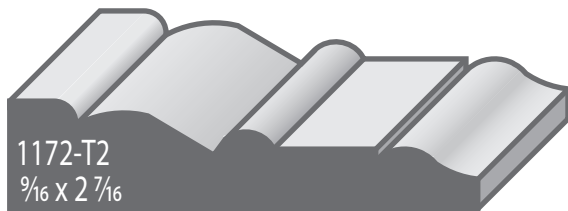
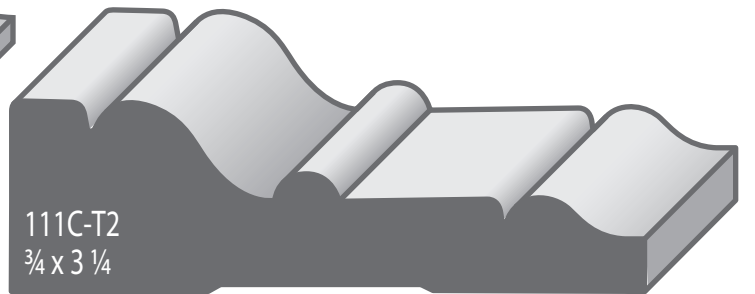
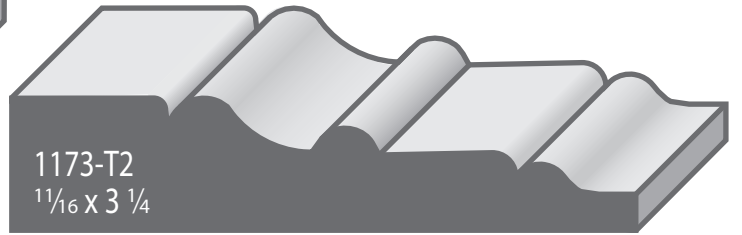
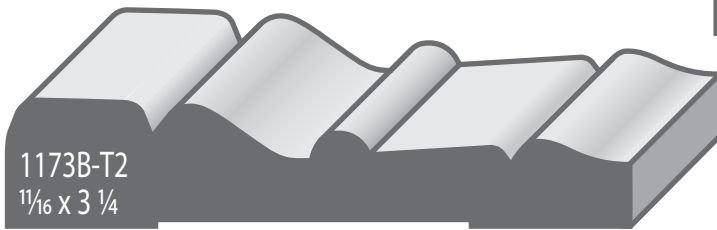
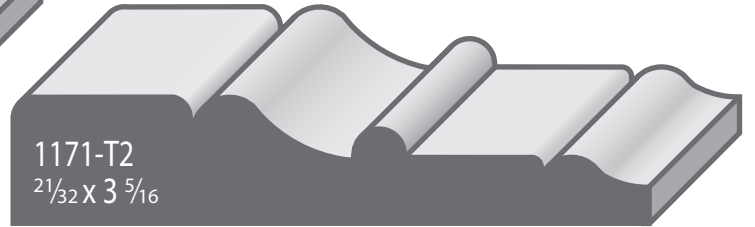
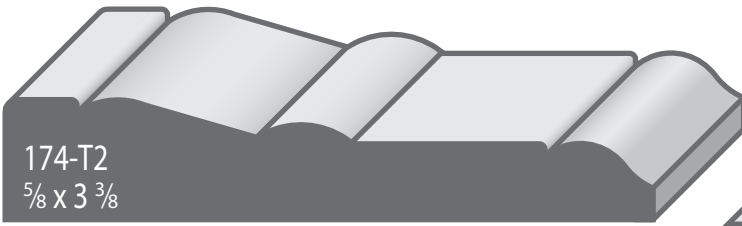

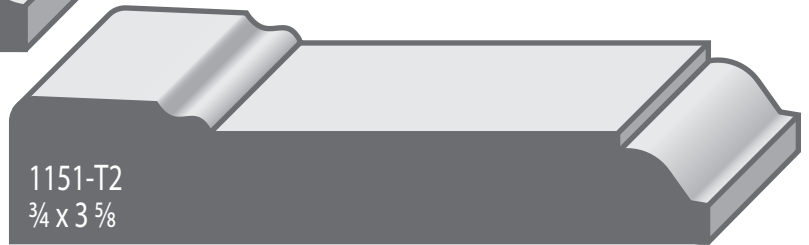
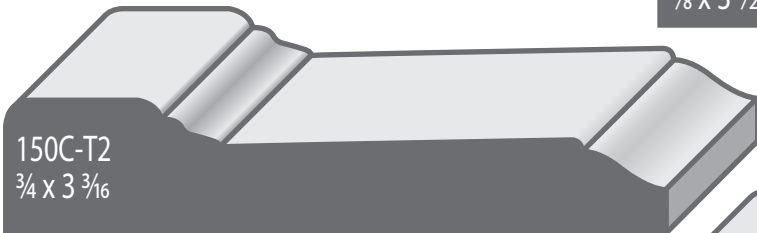
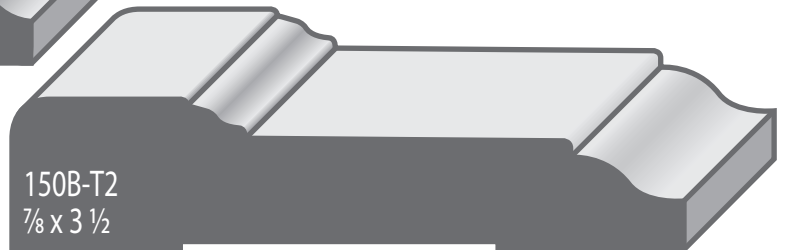
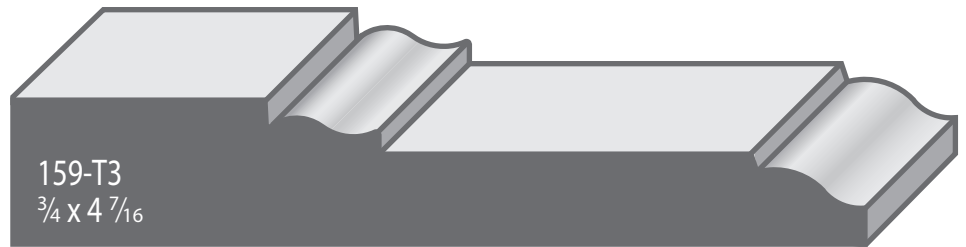
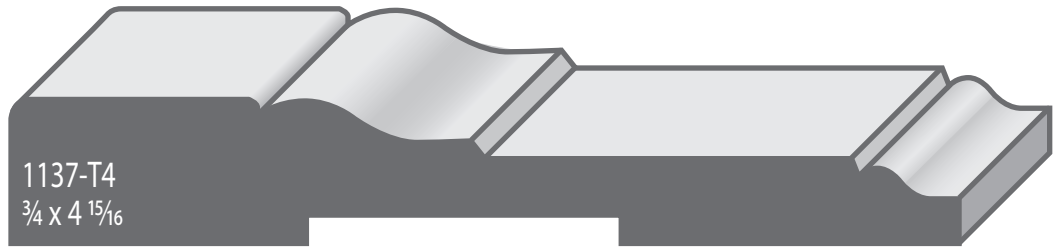

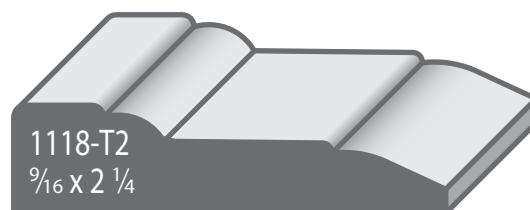
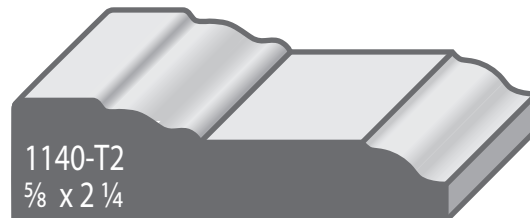
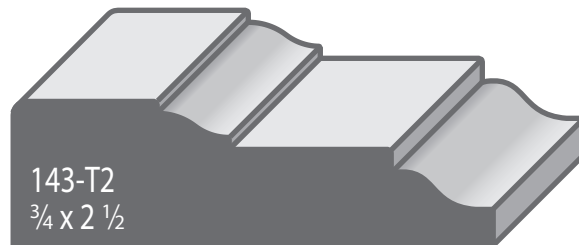
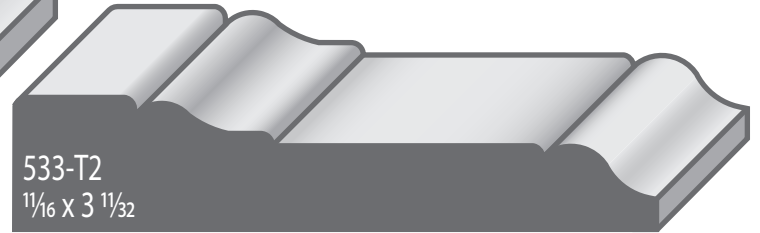

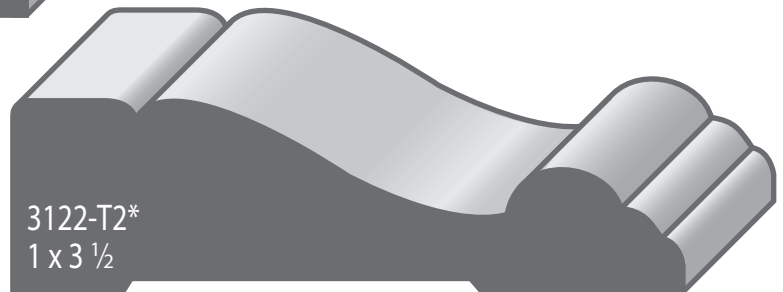
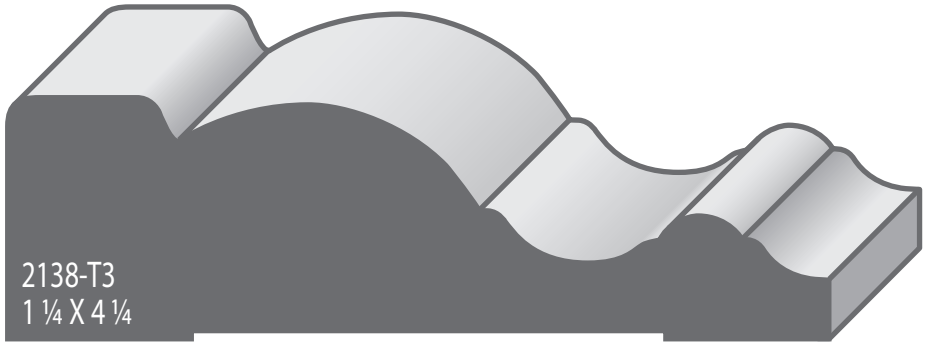
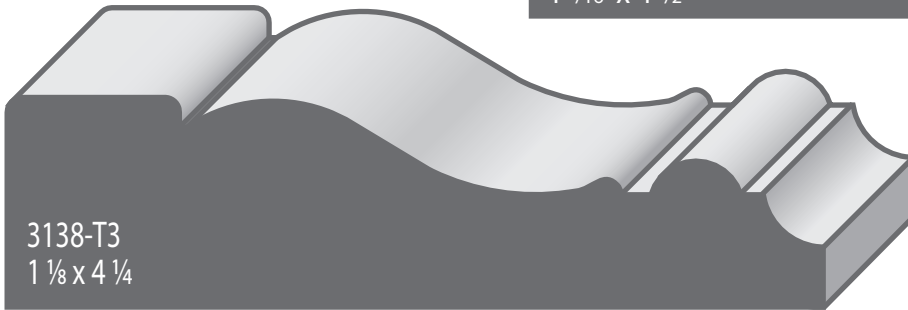
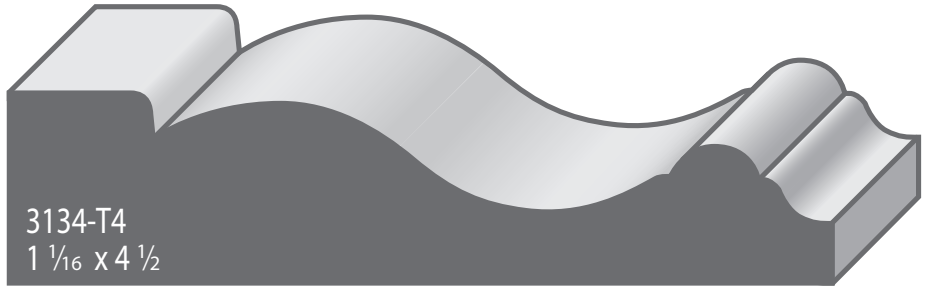
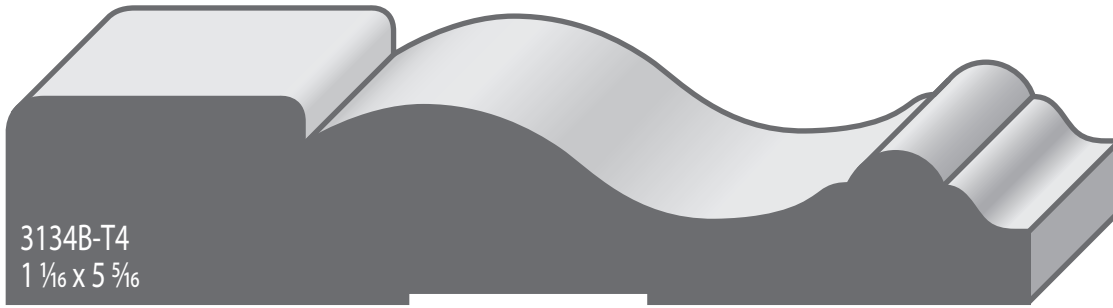

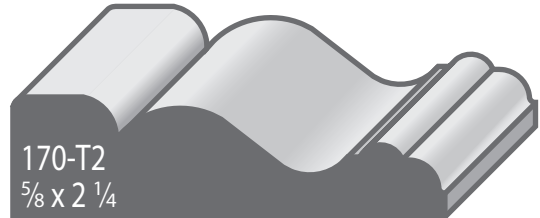
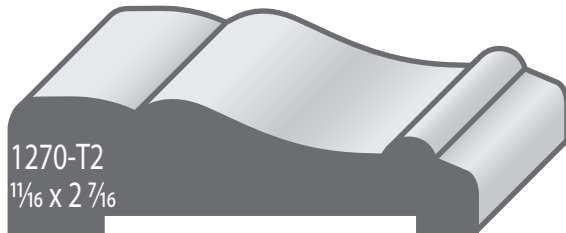
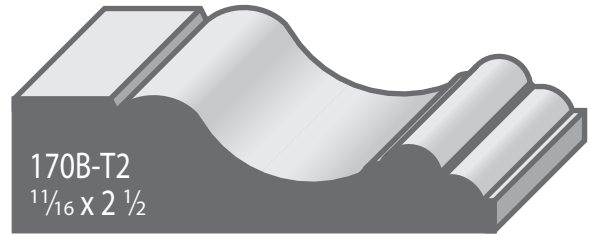
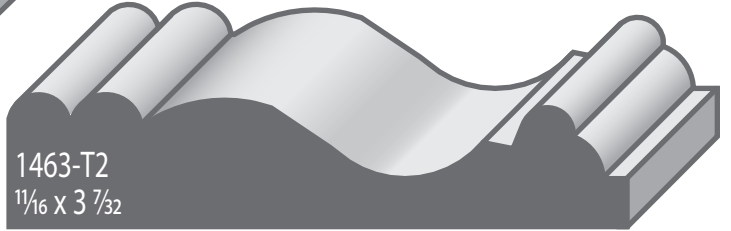
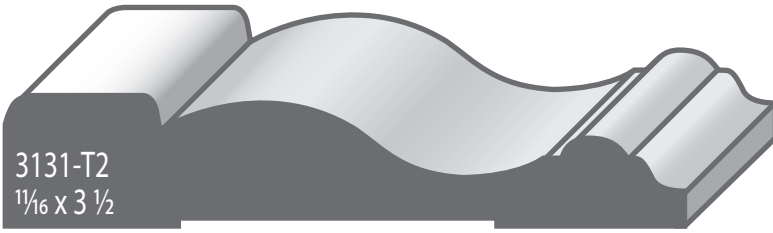

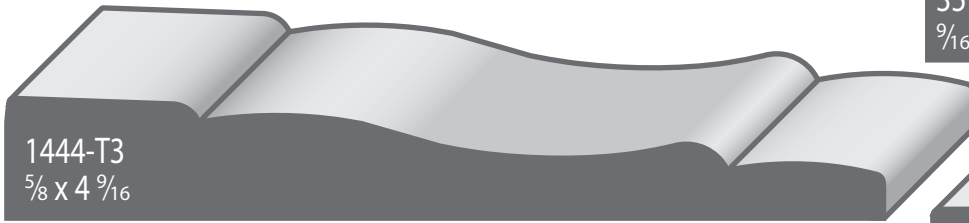

1444-T3
 $\frac{5}{8} \times 4 \frac{9}{16}$

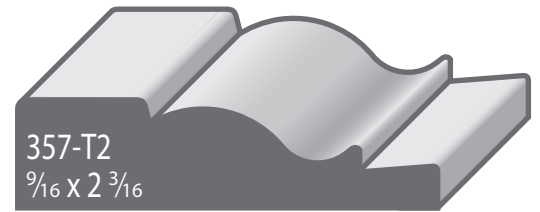

357-T2
 $\frac{9}{16} \times 2 \frac{3}{16}$

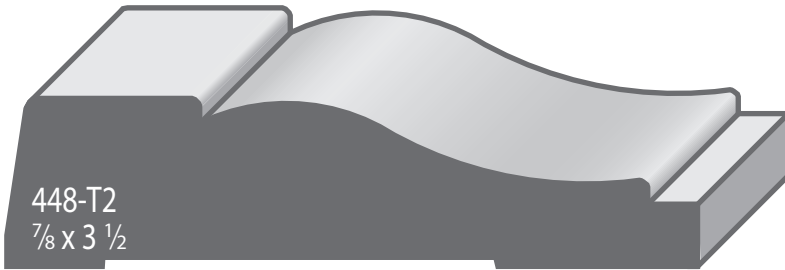

448-T2
 $\frac{7}{8} \times 3 \frac{1}{2}$

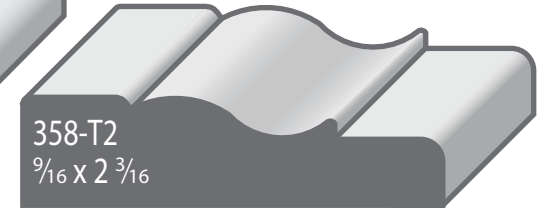

358-T2
 $\frac{9}{16} \times 2 \frac{3}{16}$

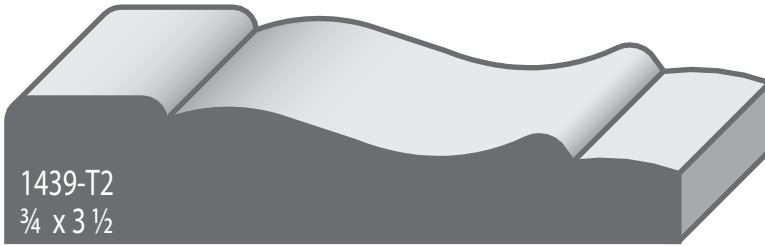

1439-T2
 $\frac{3}{4} \times 3 \frac{1}{2}$

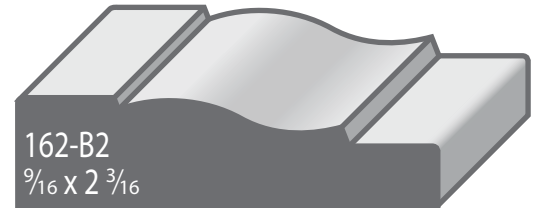

162-B2
 $\frac{9}{16} \times 2 \frac{3}{16}$

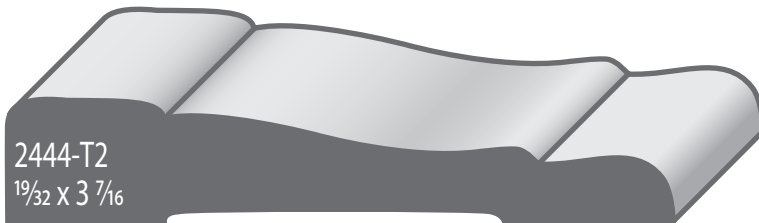

2444-T2
 $1 \frac{9}{32} \times 3 \frac{7}{16}$

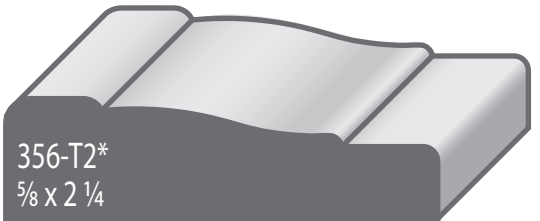

356-T2*
 $\frac{5}{8} \times 2 \frac{1}{4}$

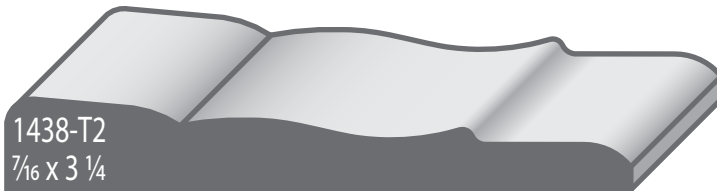

1438-T2
 $\frac{7}{16} \times 3 \frac{1}{4}$

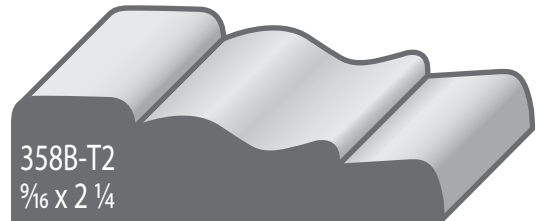

358B-T2
 $\frac{9}{16} \times 2 \frac{1}{4}$

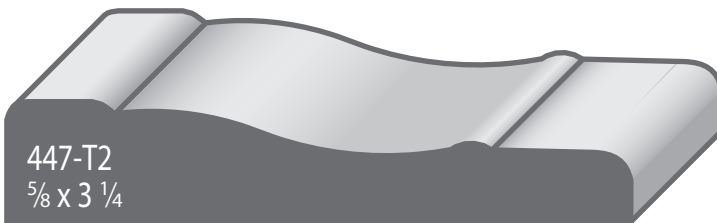

447-T2
 $\frac{5}{8} \times 3 \frac{1}{4}$

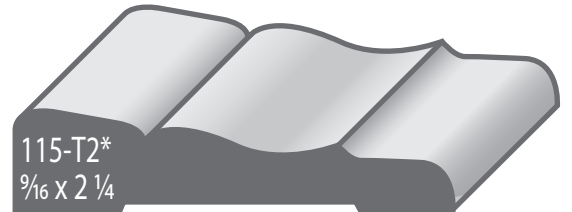

115-T2*
 $\frac{9}{16} \times 2 \frac{1}{4}$

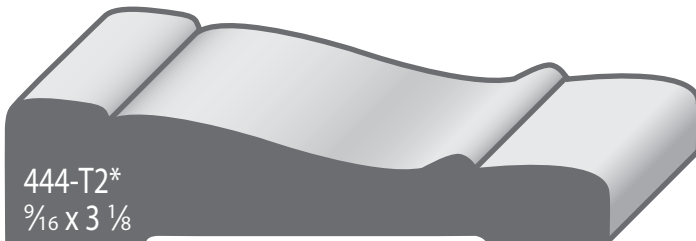

444-T2*
 $\frac{9}{16} \times 3 \frac{1}{8}$

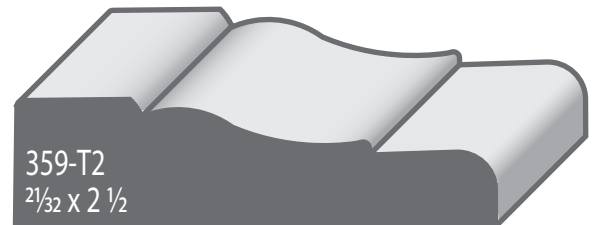

359-T2
 $2 \frac{1}{32} \times 2 \frac{1}{2}$

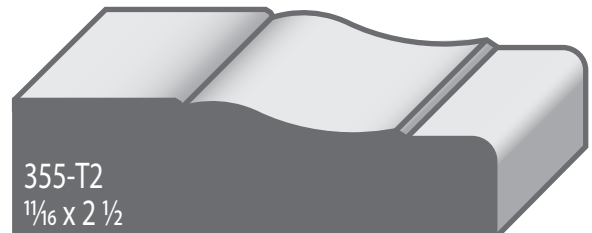

355-T2
 $1 \frac{1}{16} \times 2 \frac{1}{2}$

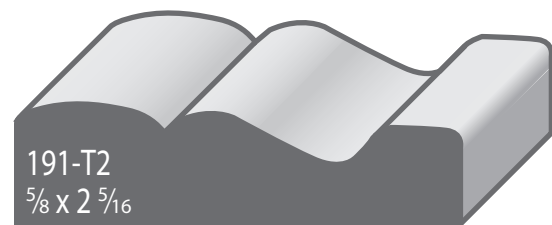
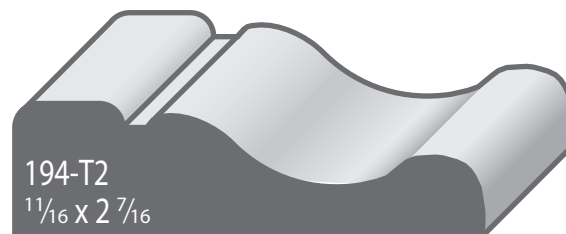
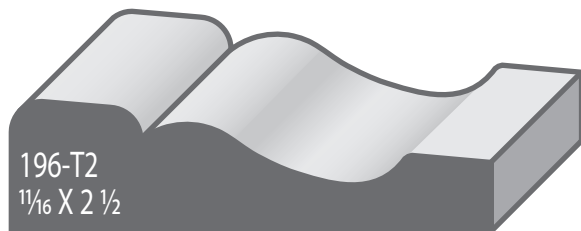
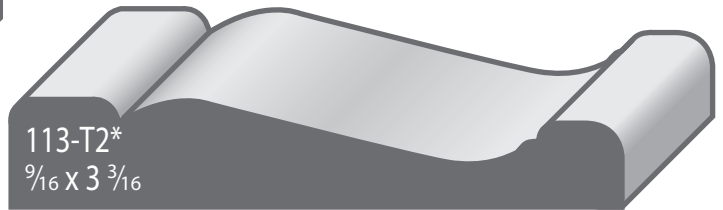
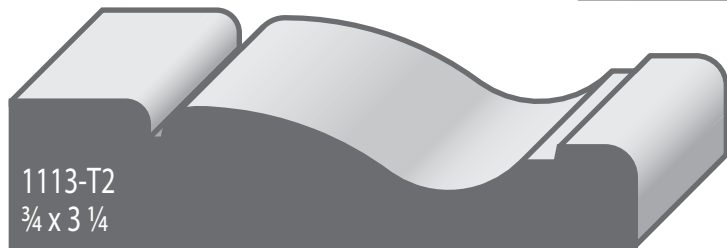
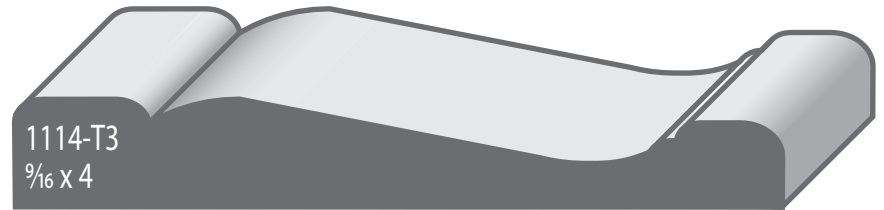

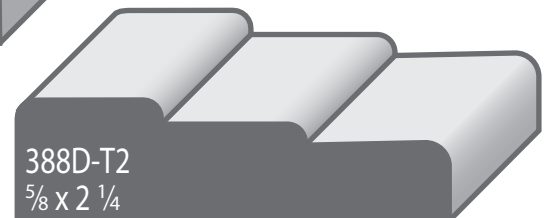
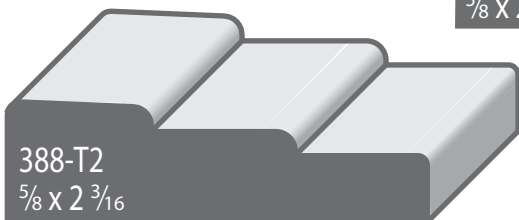
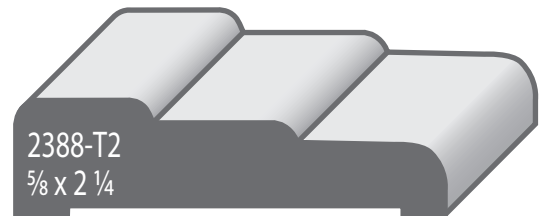
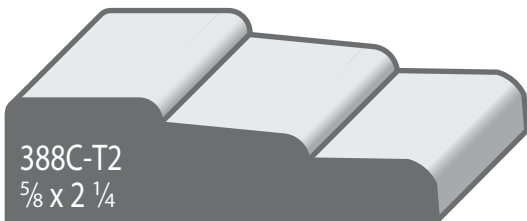
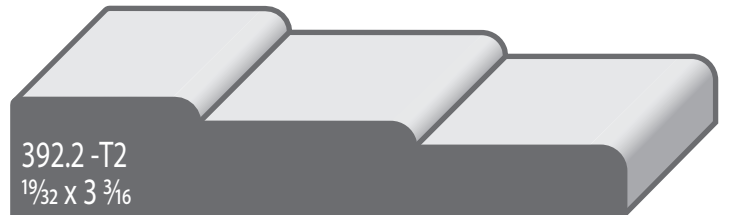
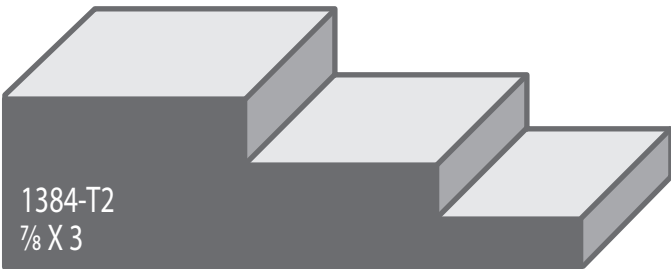
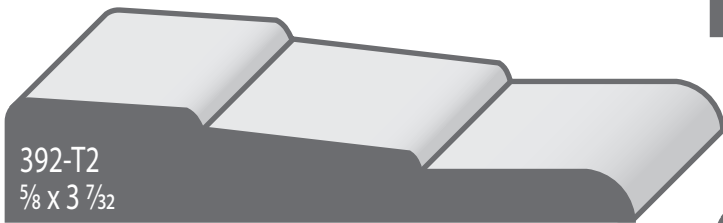
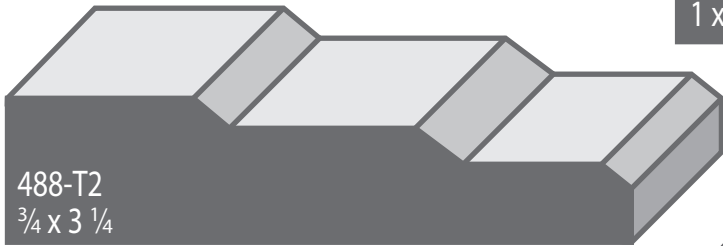
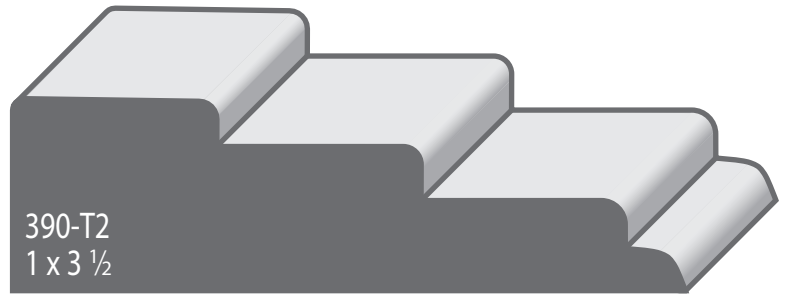

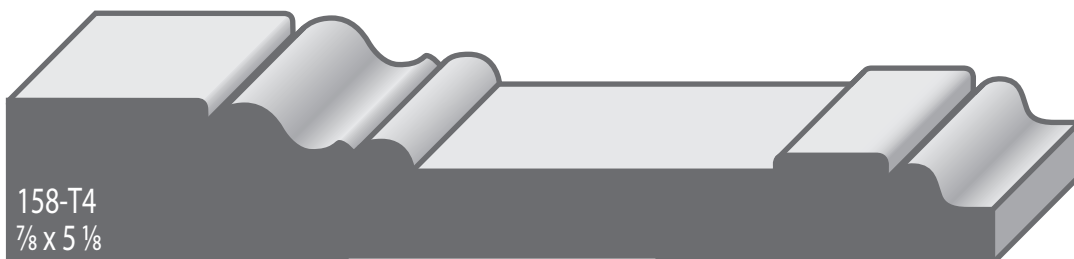
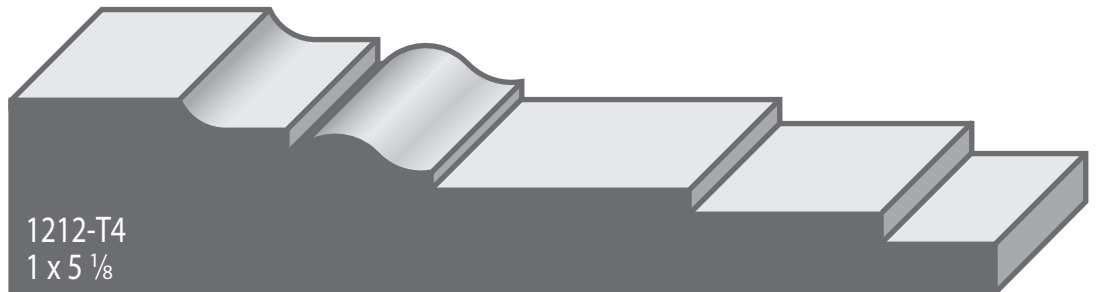
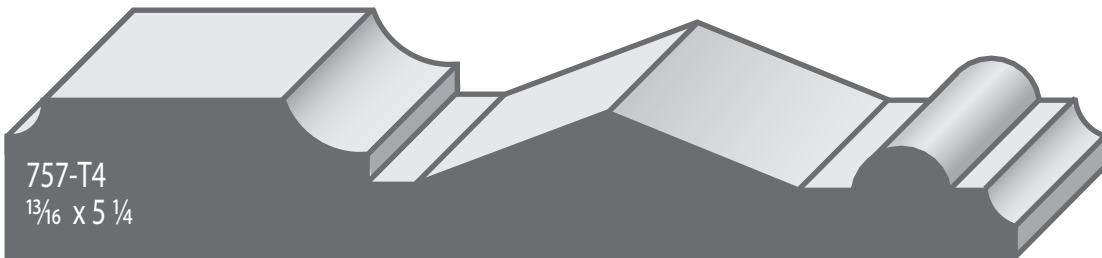
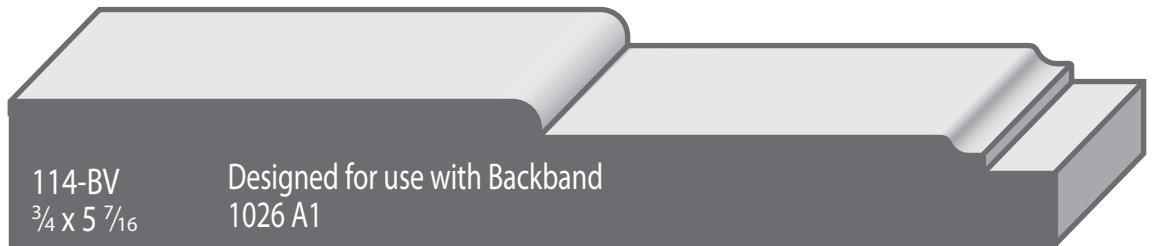
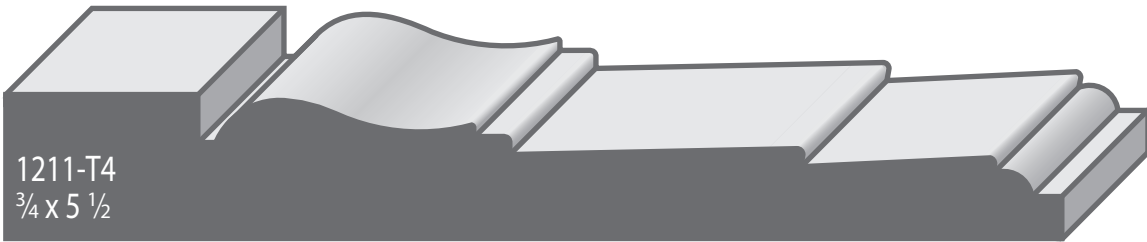
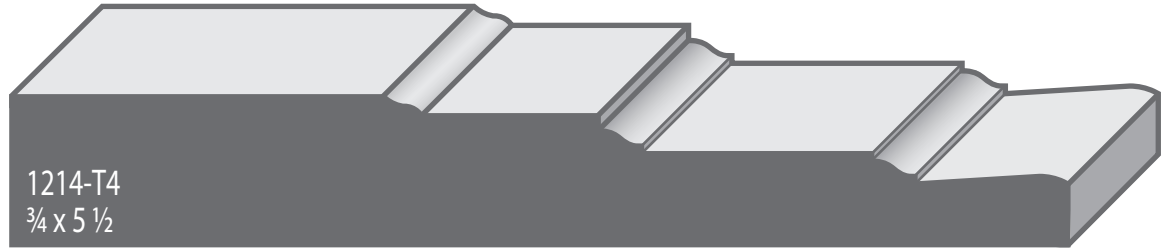

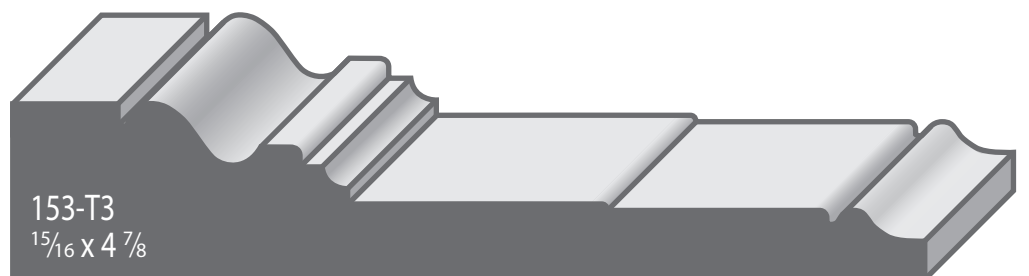
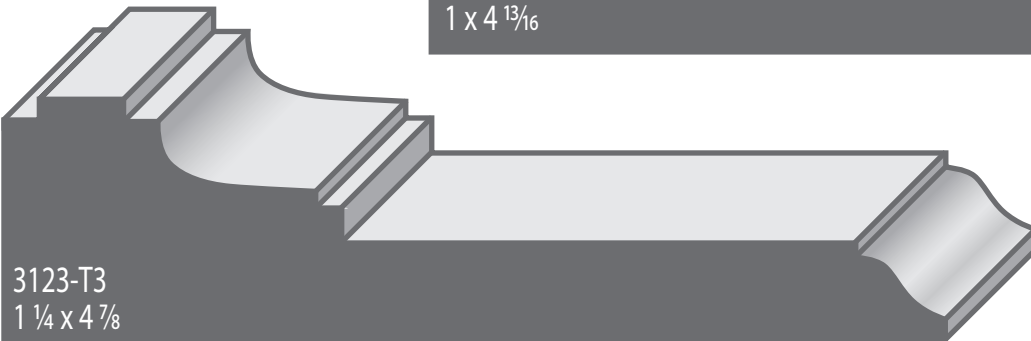
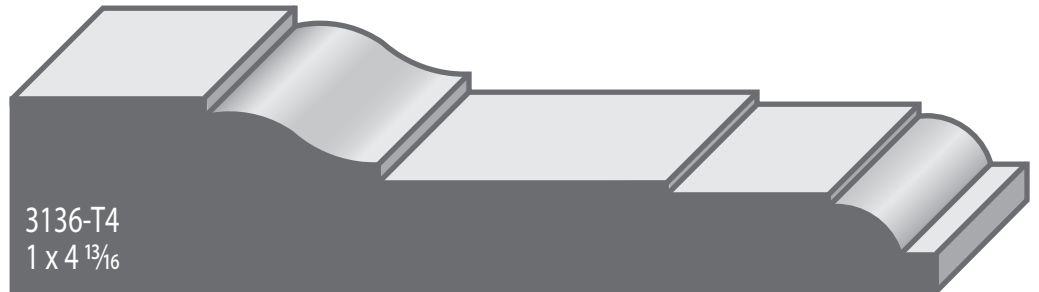
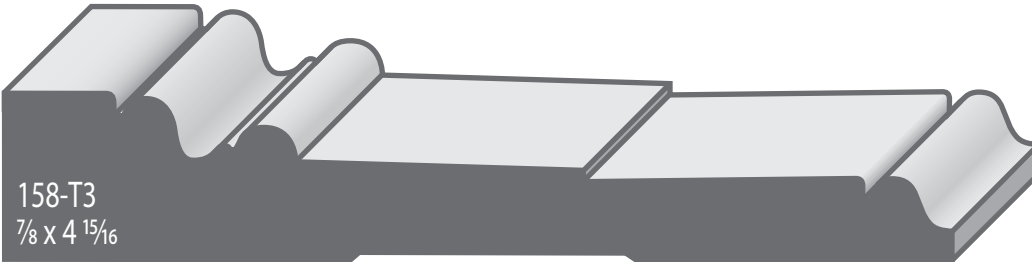
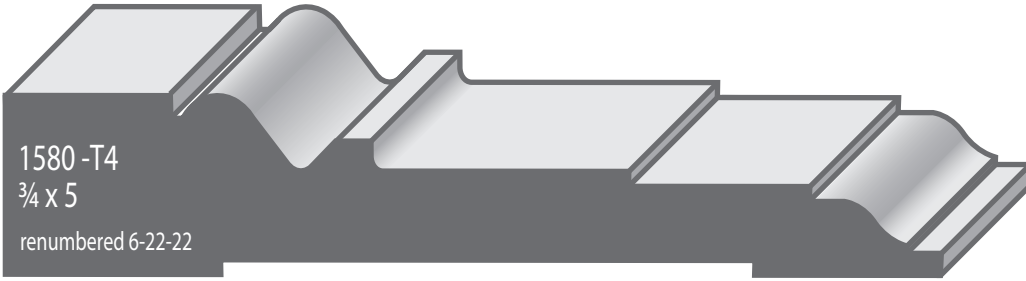

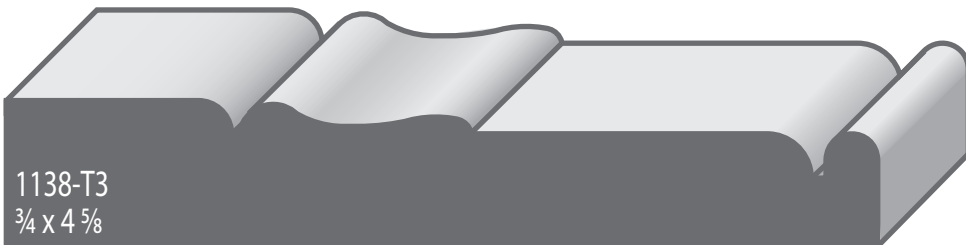
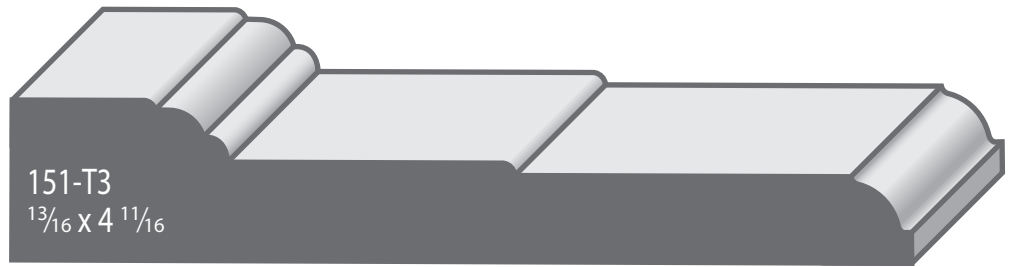
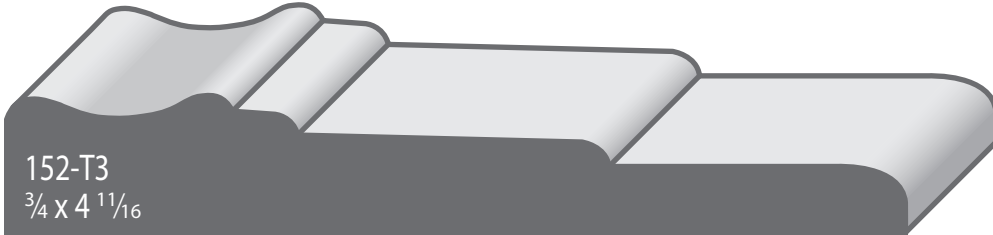
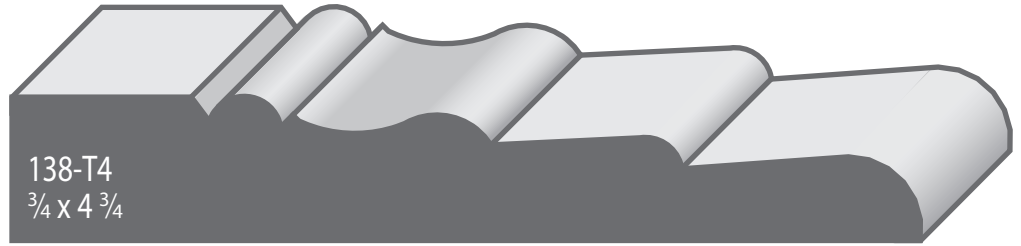

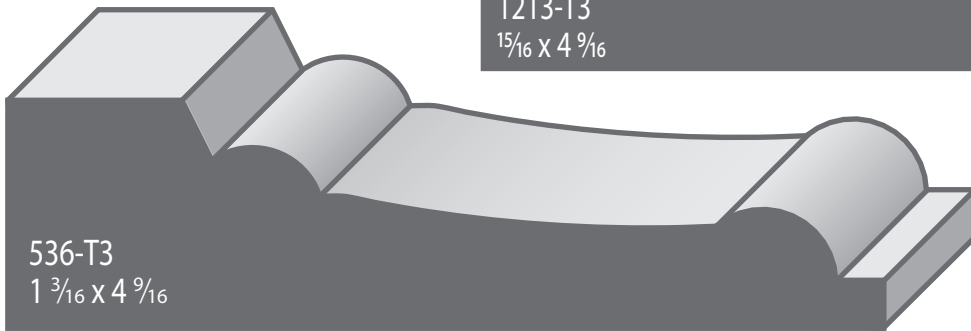
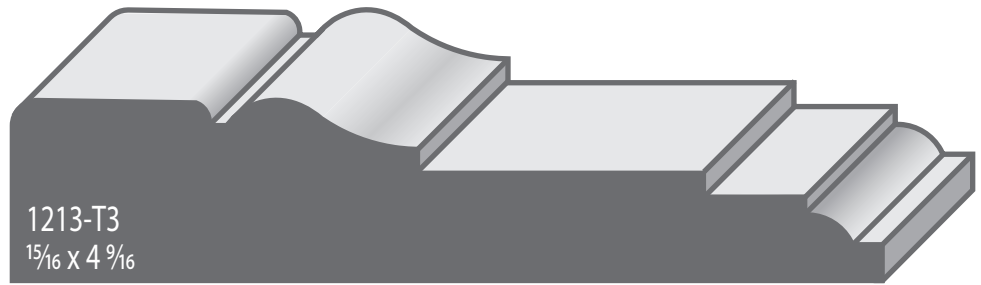
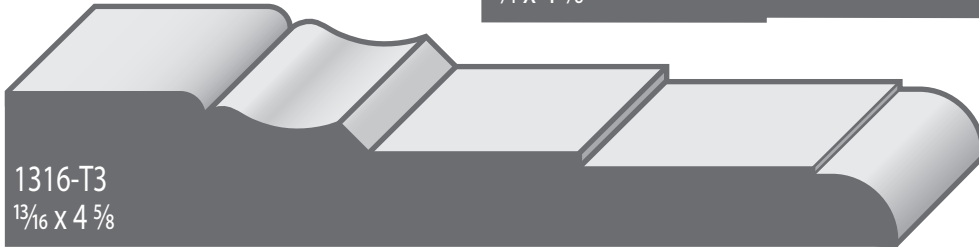
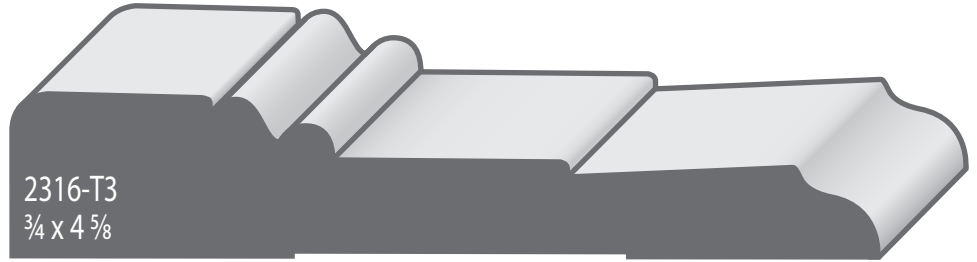

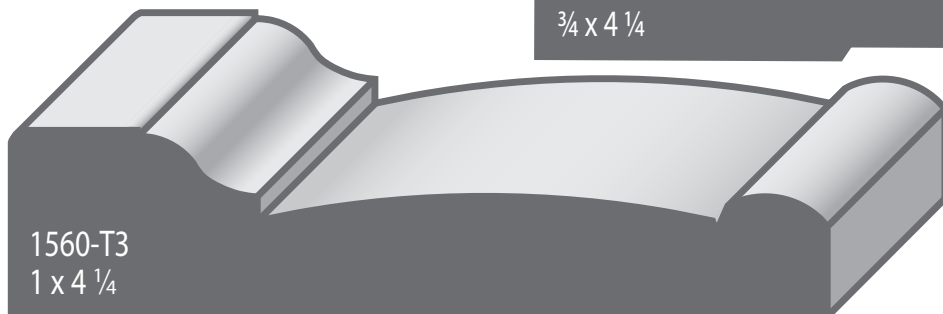
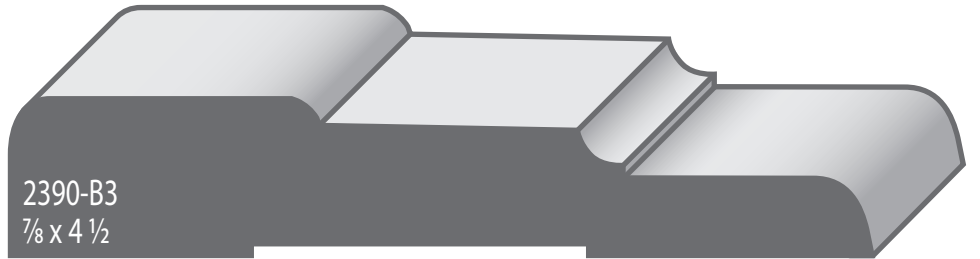
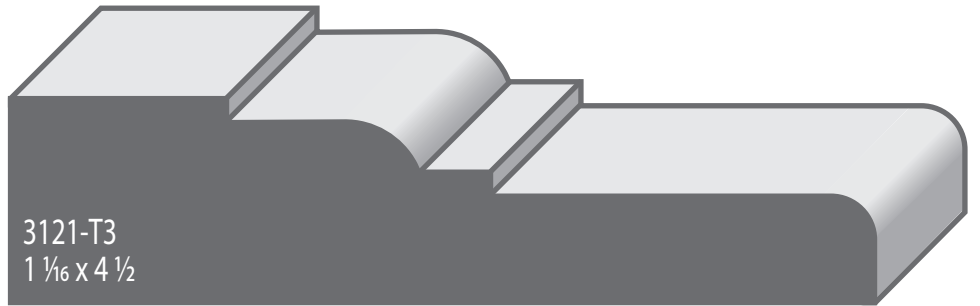
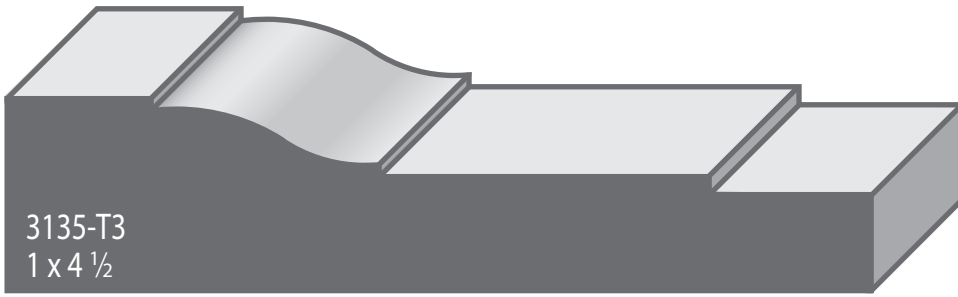

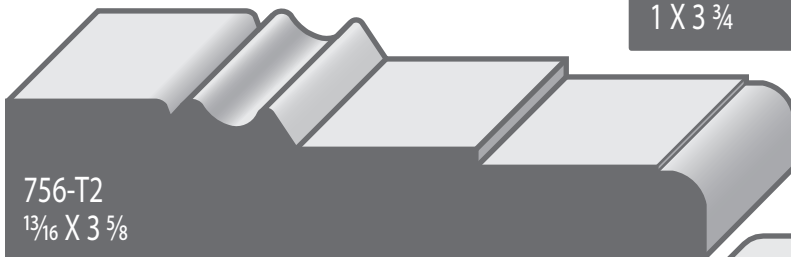
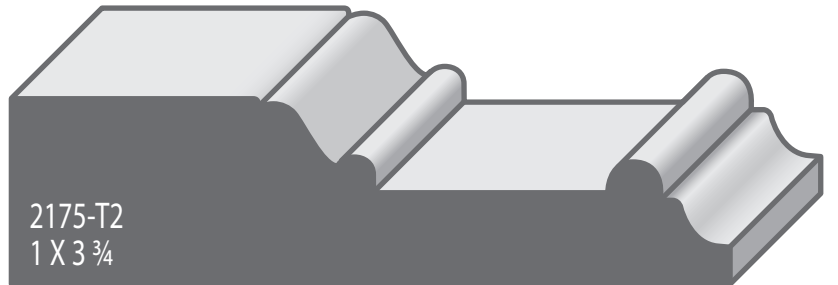
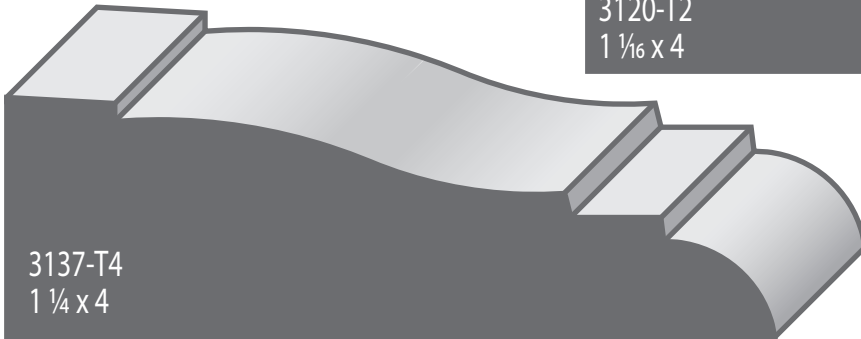
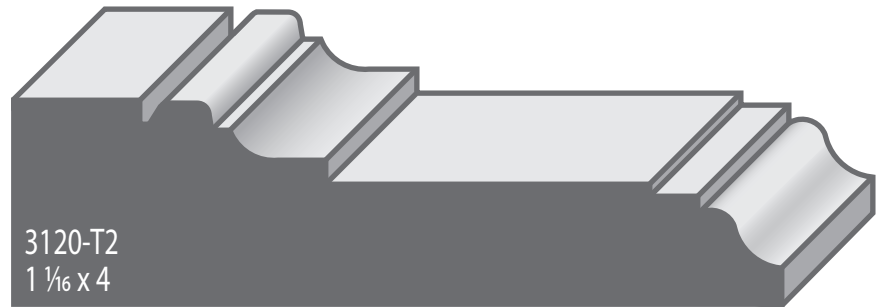
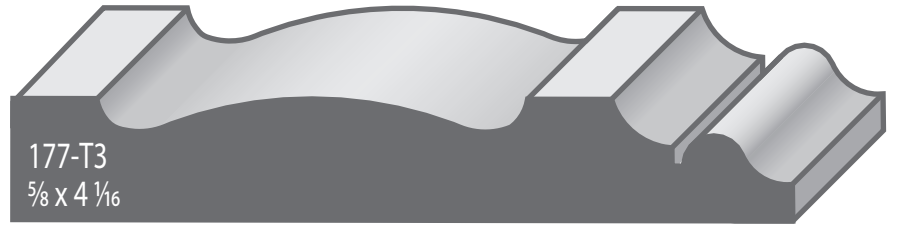

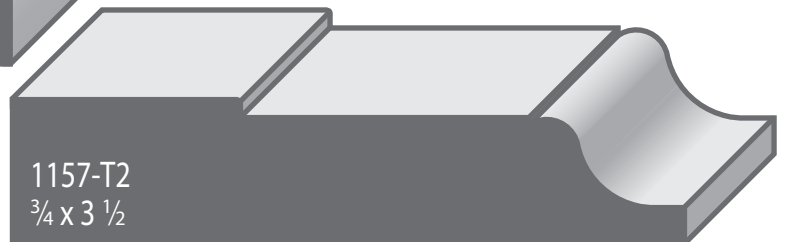
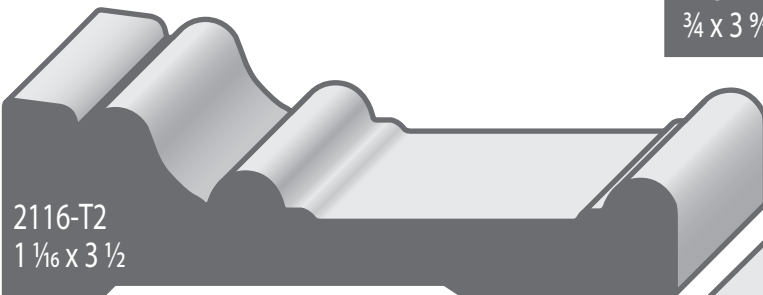
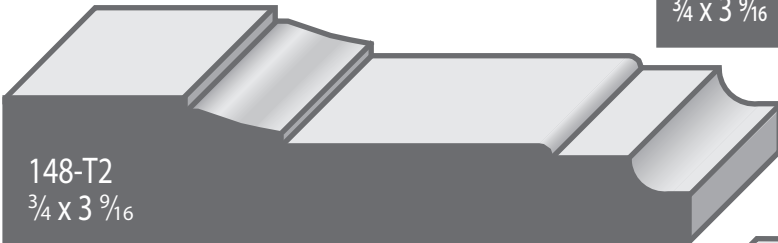
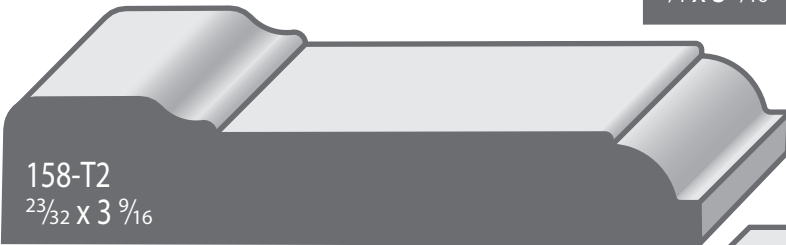
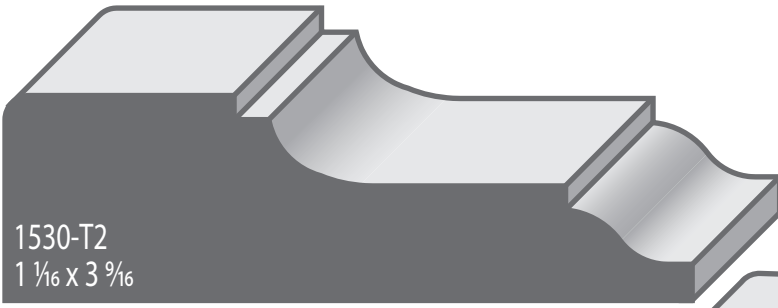

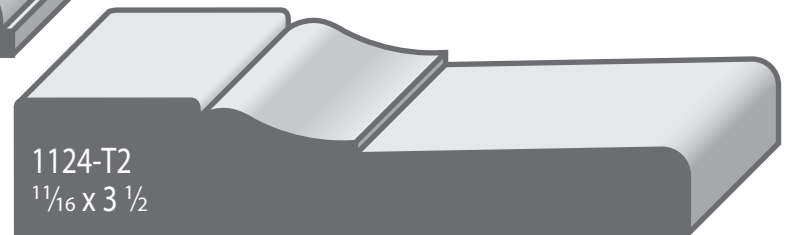
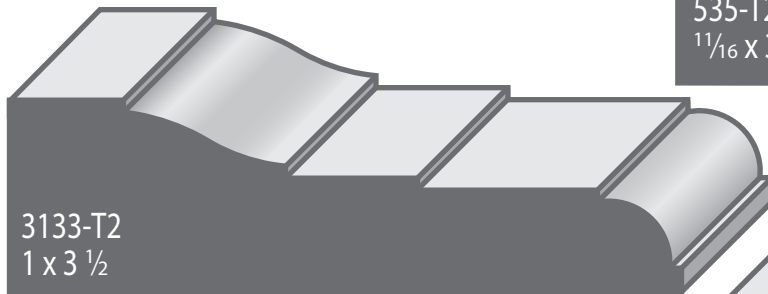
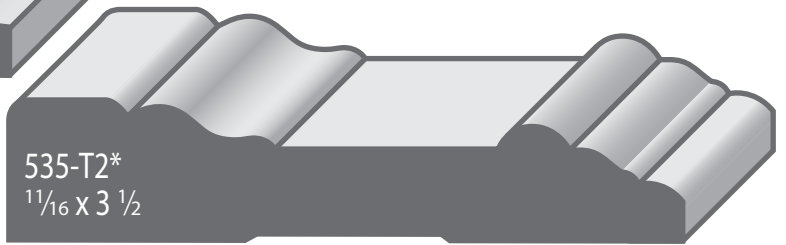
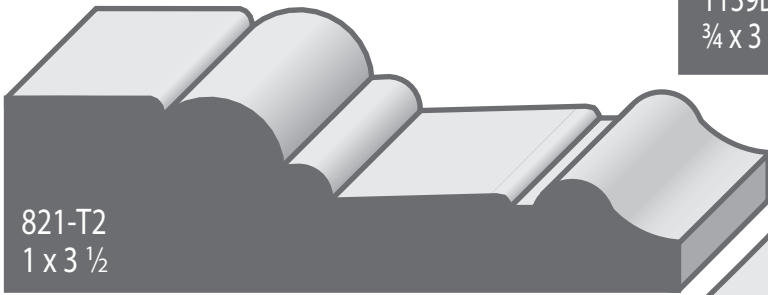
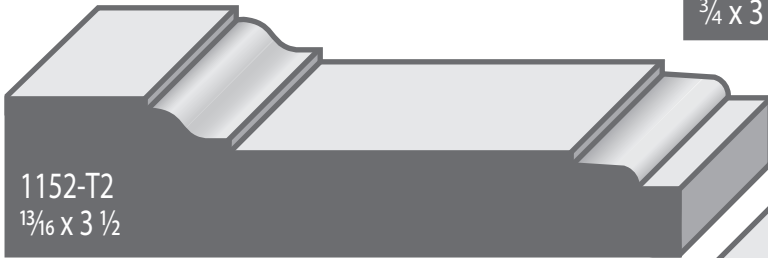
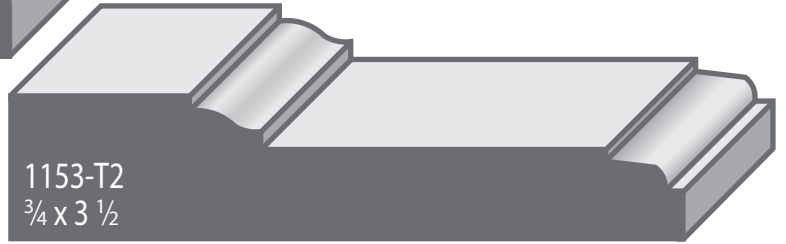
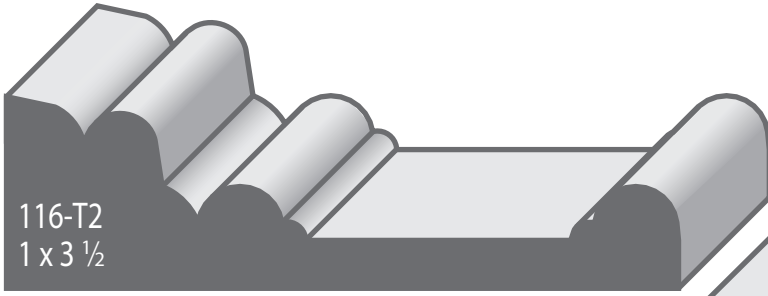

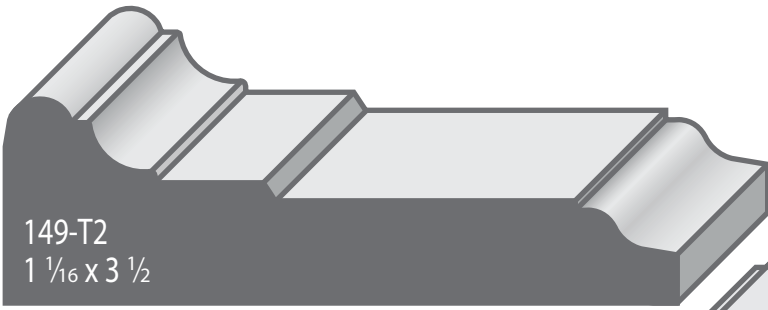

149-T2
1 1/16 x 3 1/2



1159-T2
1 x 3 1/2

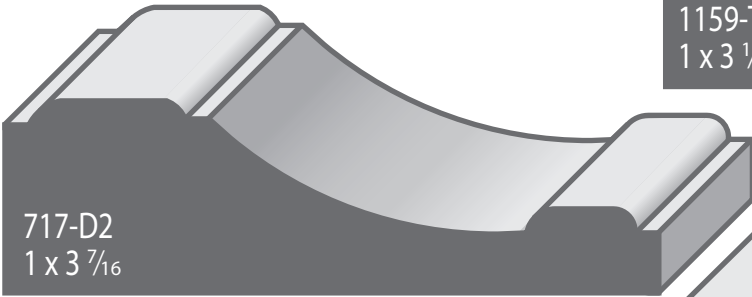

717-D2
1 x 3 7/16

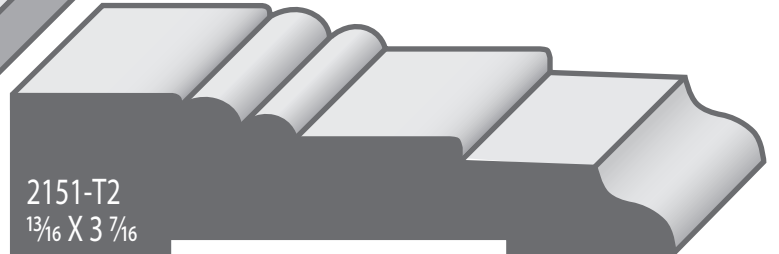

2151-T2
1 3/16 x 3 7/16

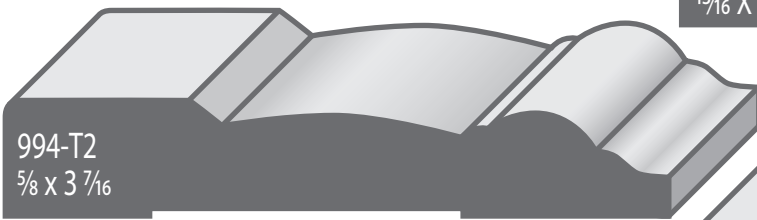

994-T2
5/8 x 3 7/16



1156-T2
3/4 x 3 3/8

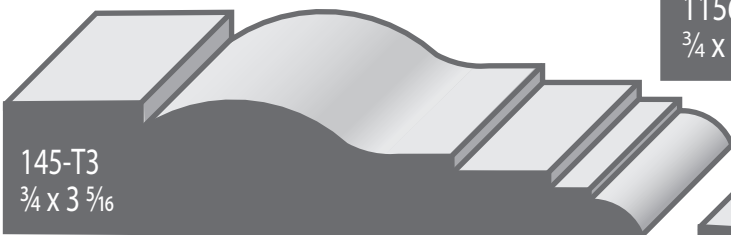

145-T3
3/4 x 3 5/16

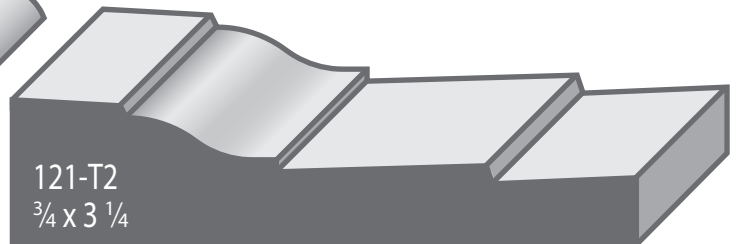

121-T2
3/4 x 3 1/4

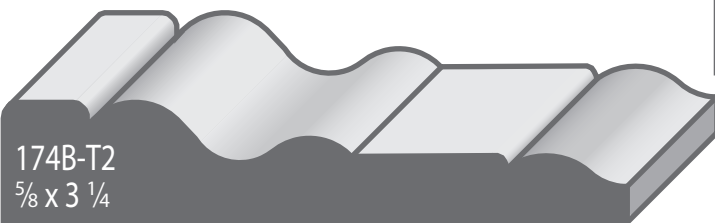

174B-T2
5/8 x 3 1/4

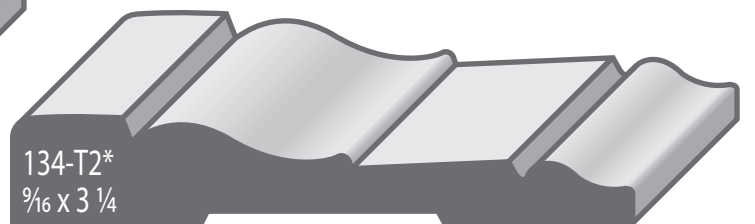

134-T2*
5/16 x 3 1/4

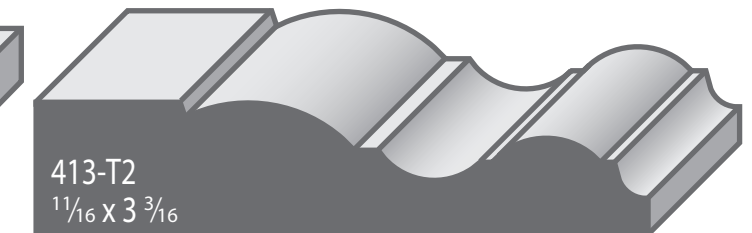
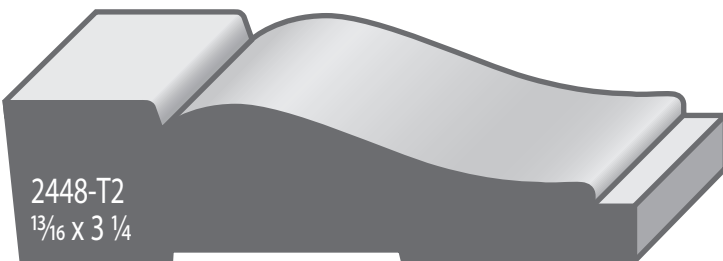
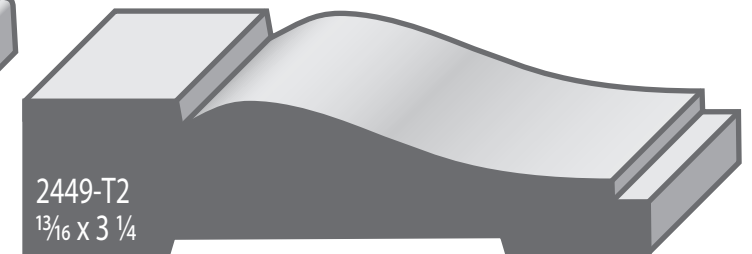
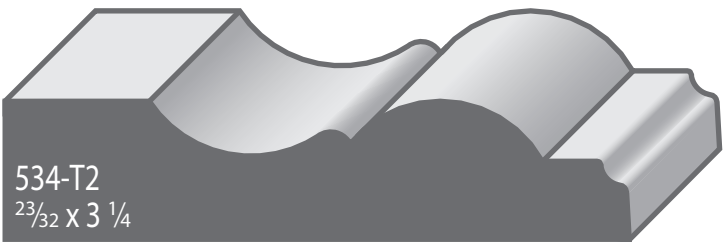
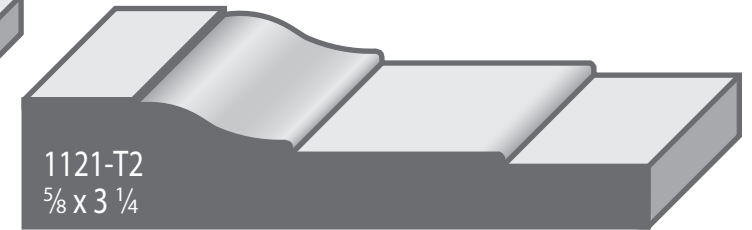
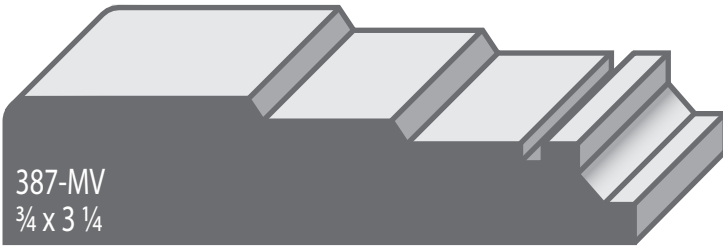
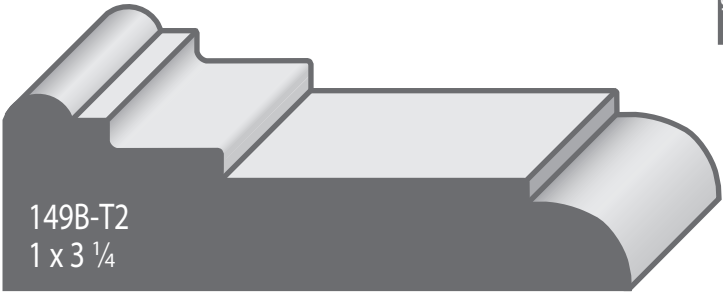
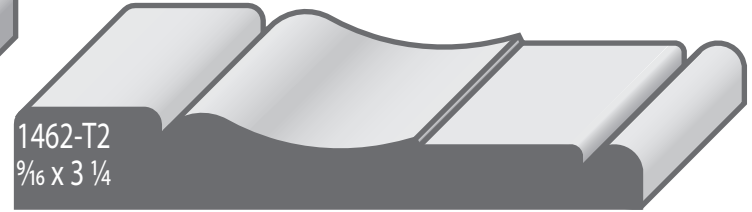
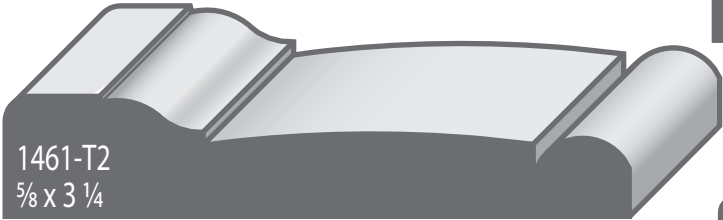
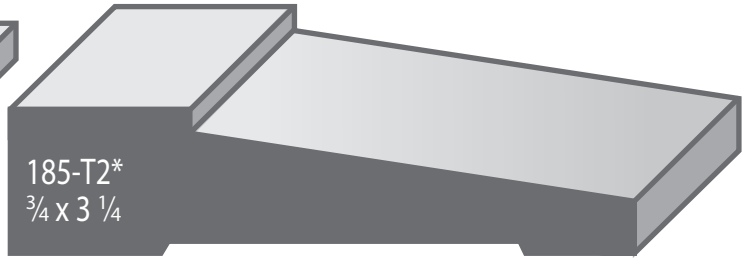

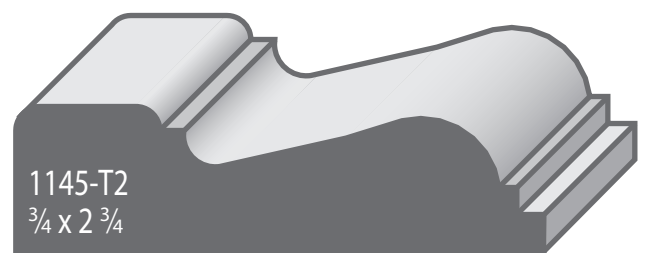
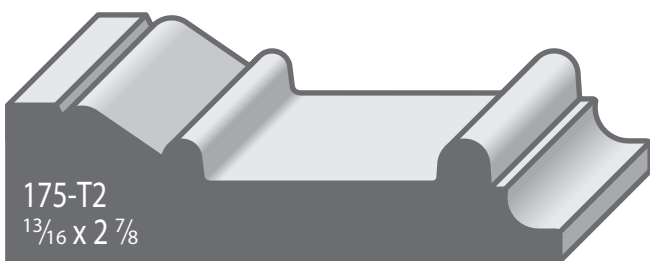
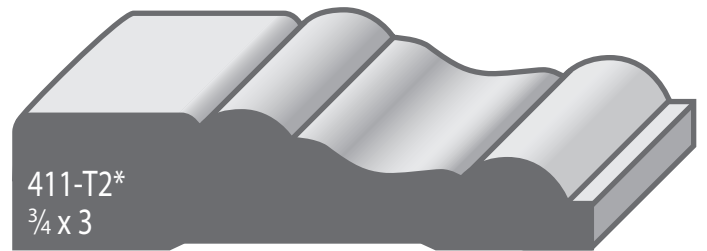
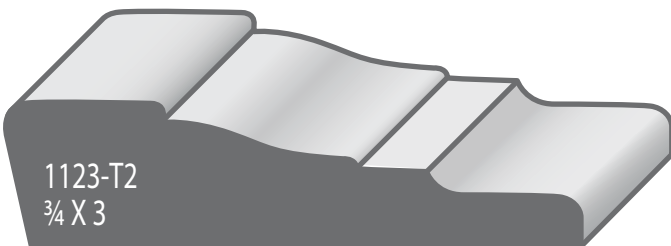
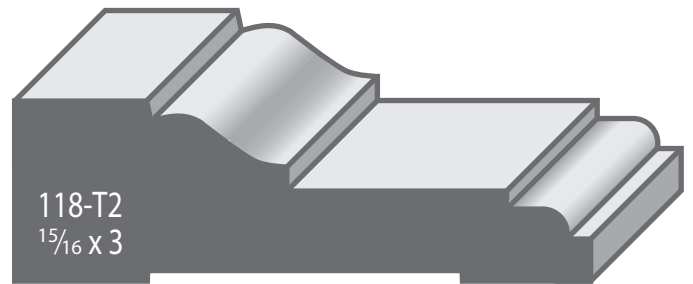
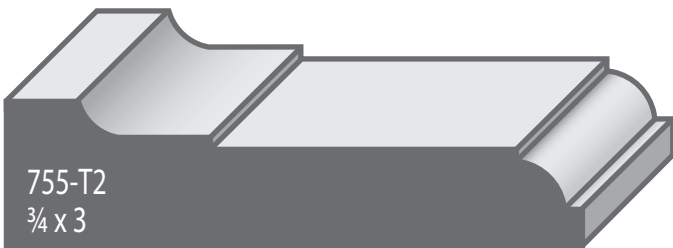
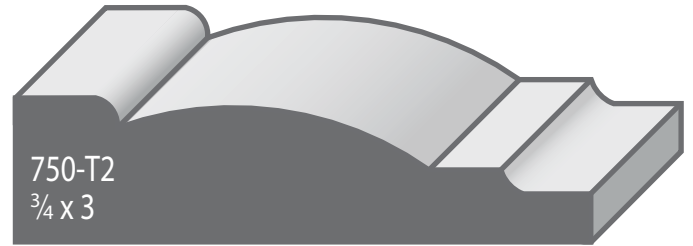
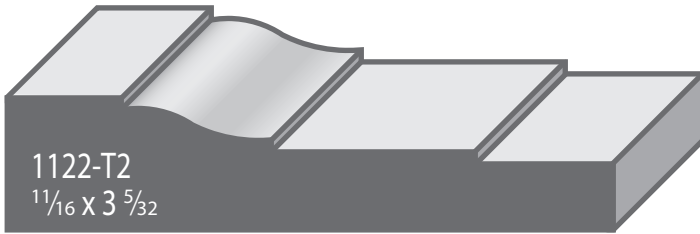
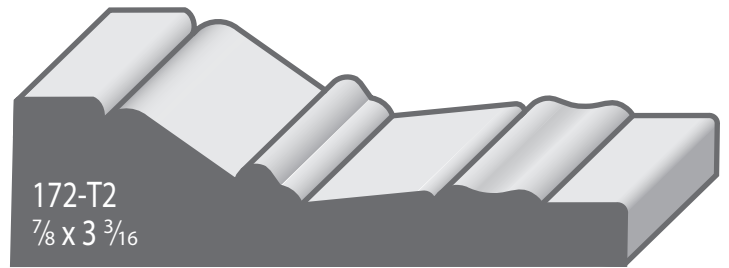

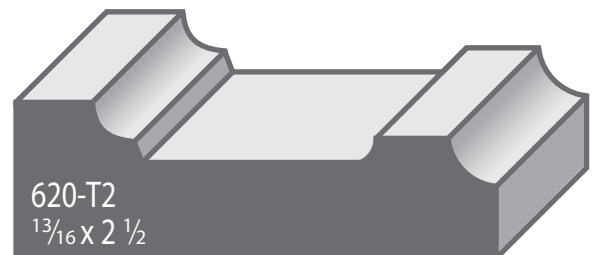
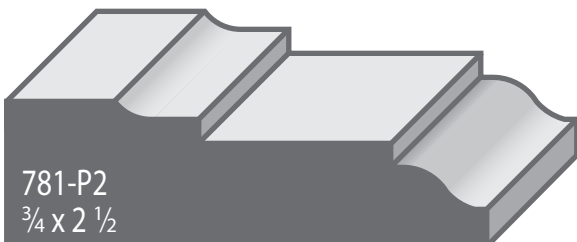
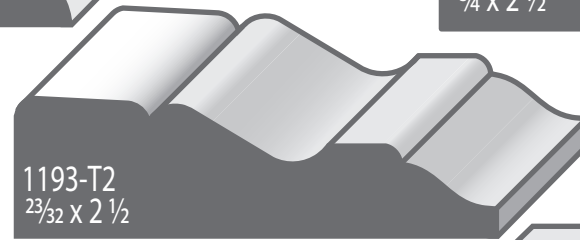
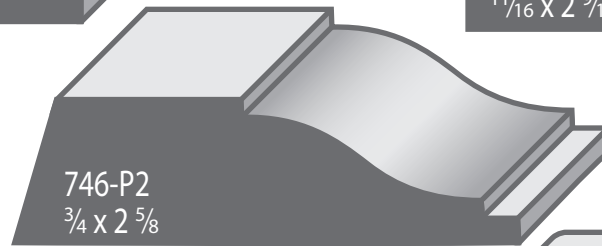
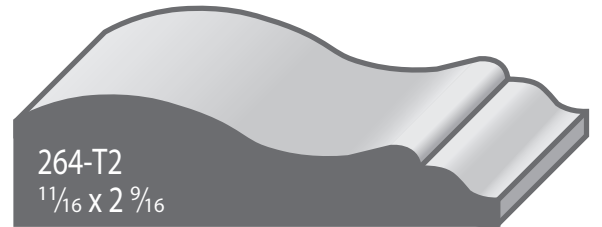
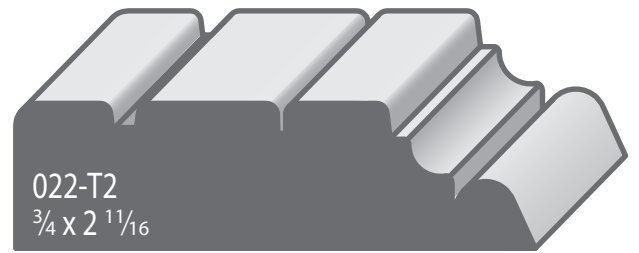
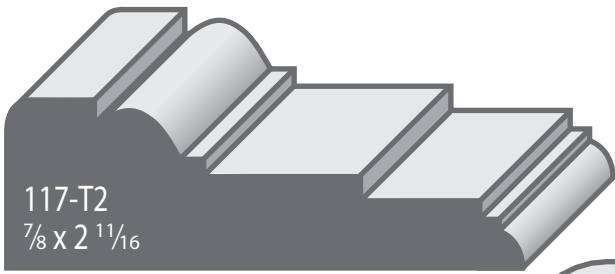

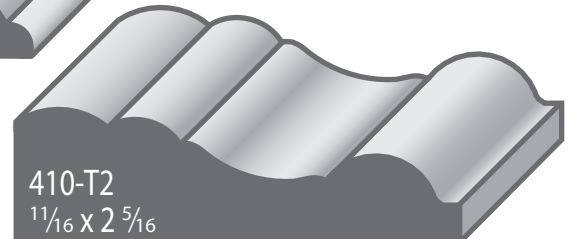
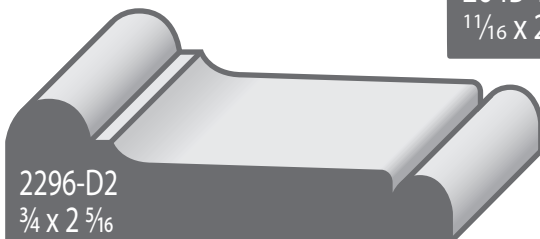
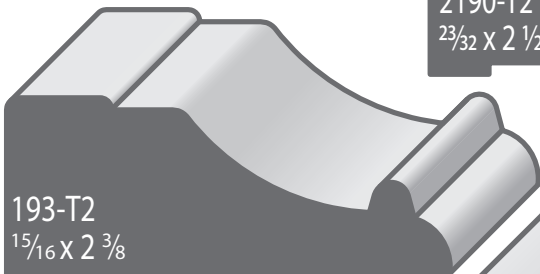
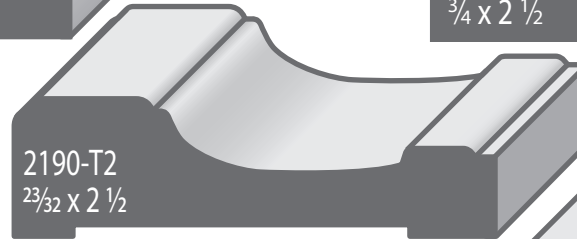
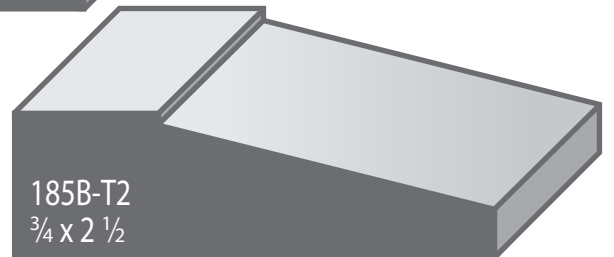
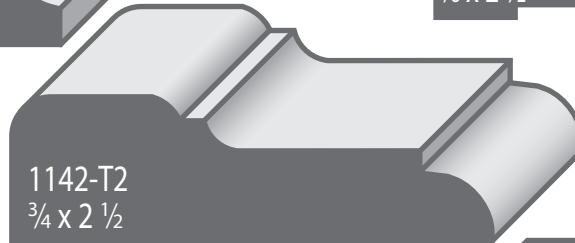
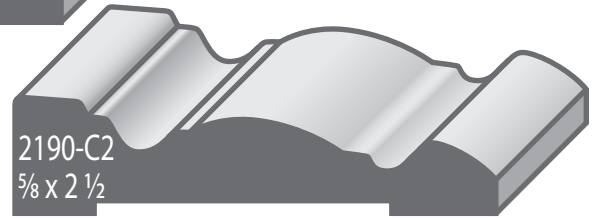
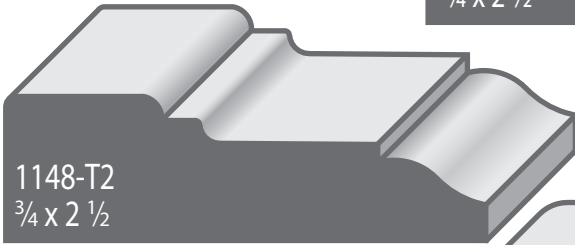
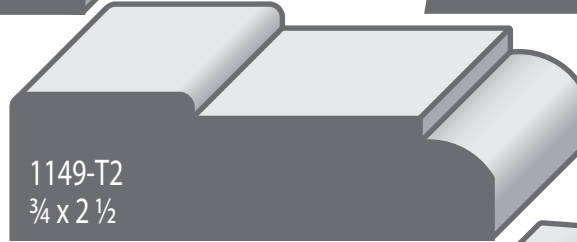
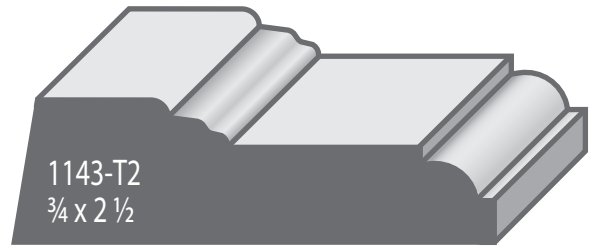
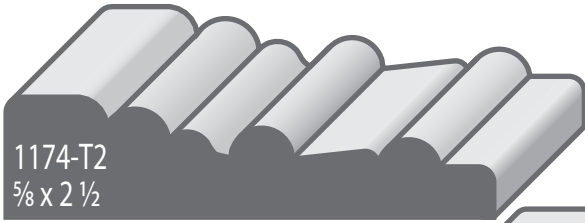

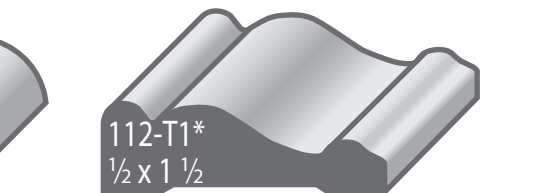
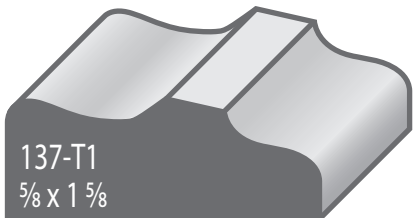
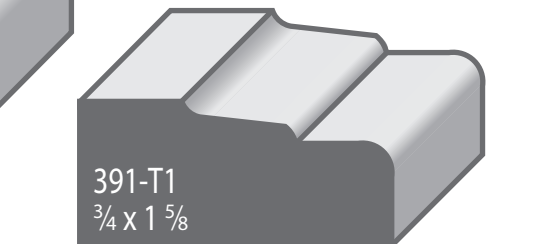
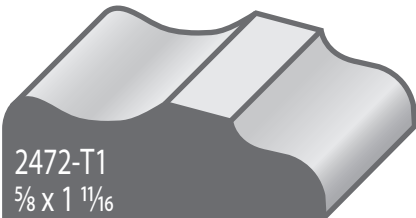
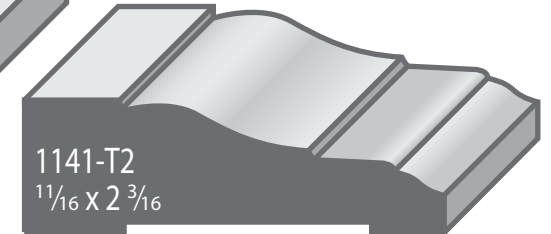
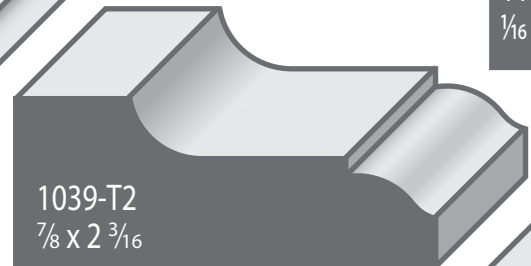
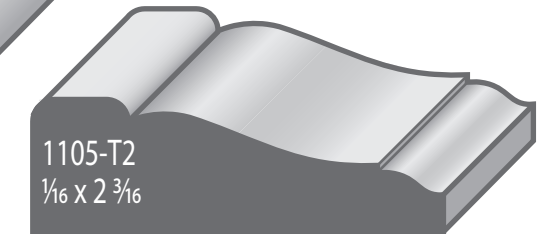
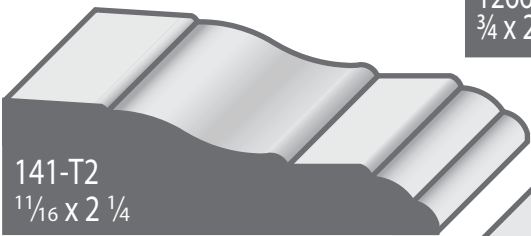
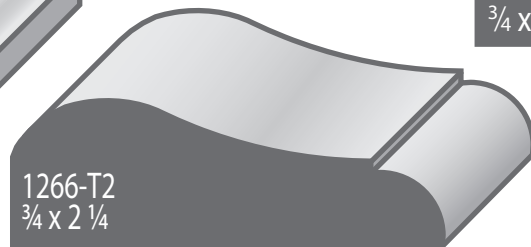
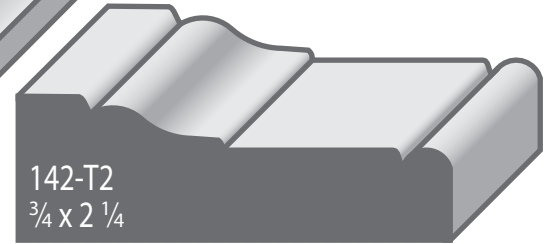
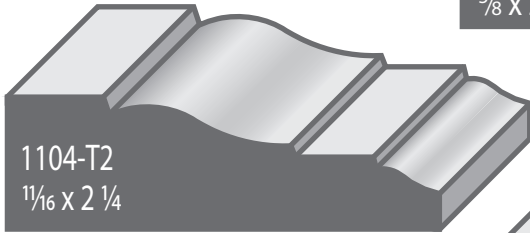
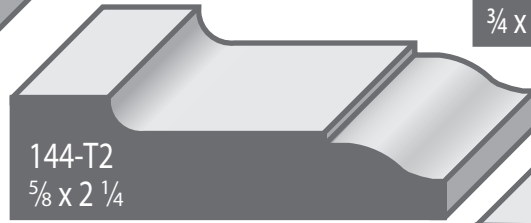
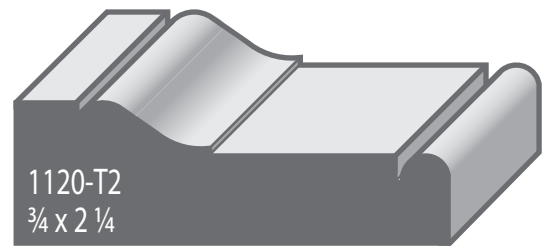

Pair with Plinth #1037 T2 and Base 331 BV

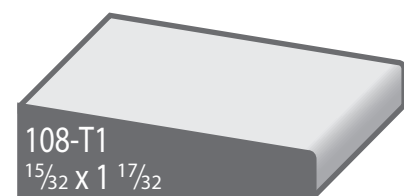
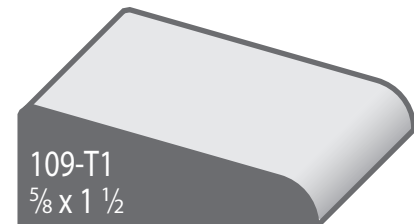
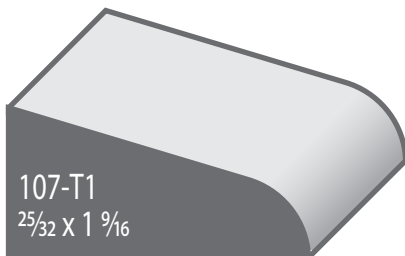
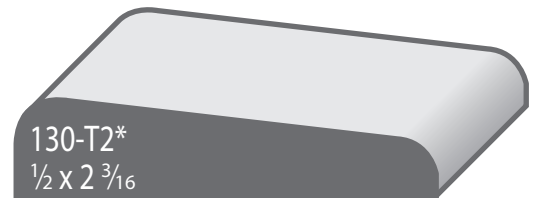
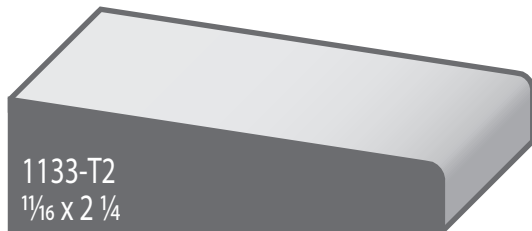
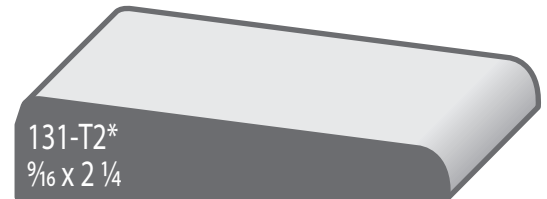
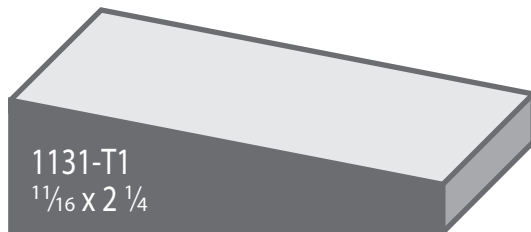
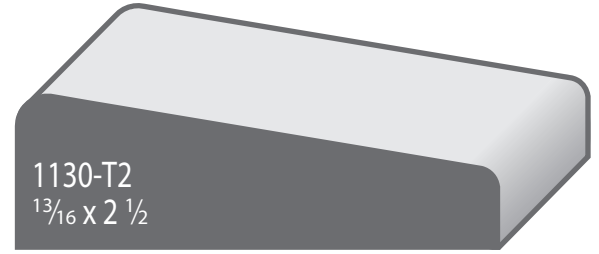
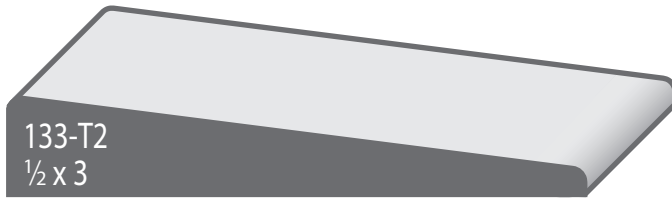

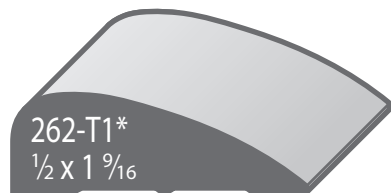
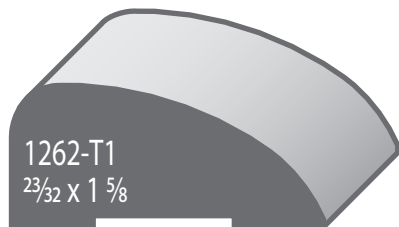
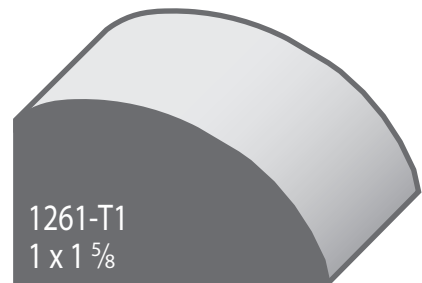
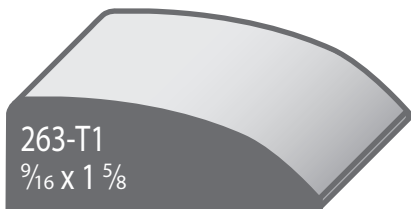
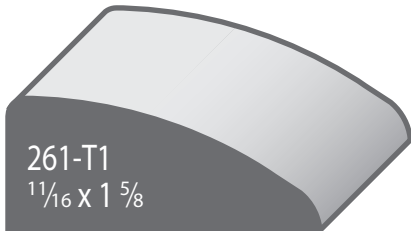
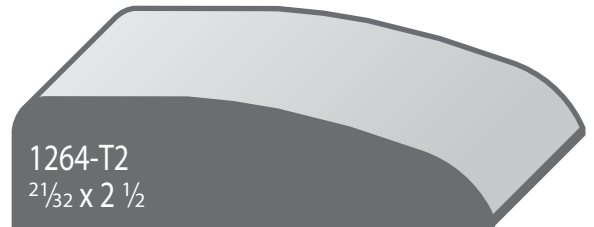
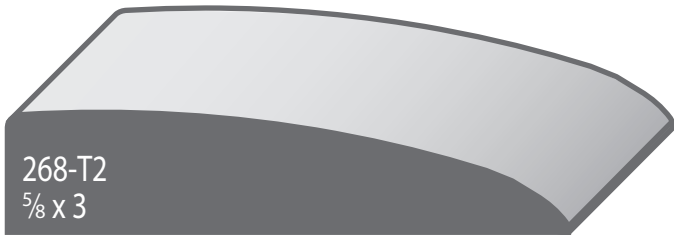

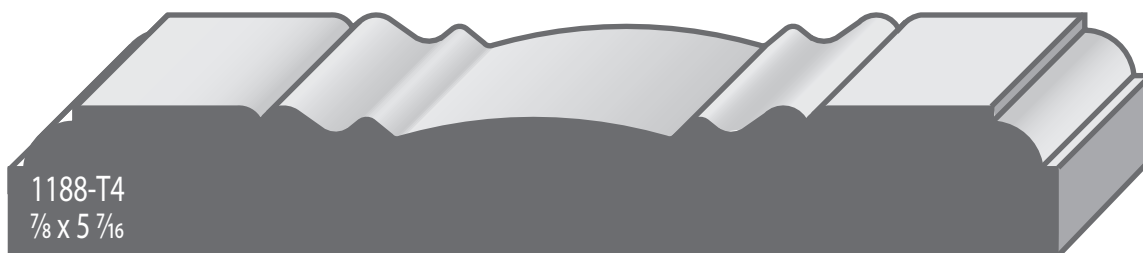
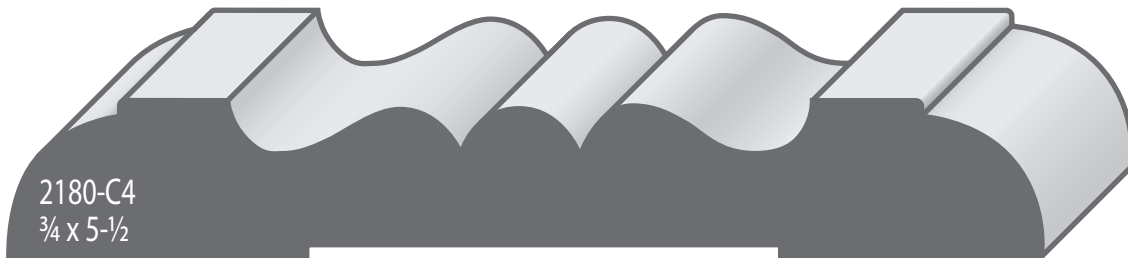
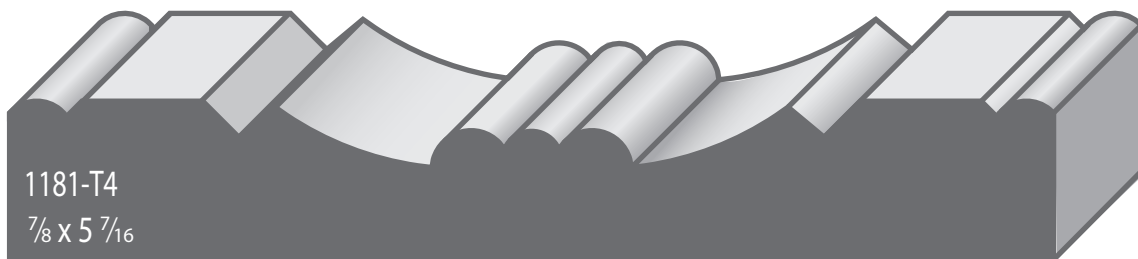
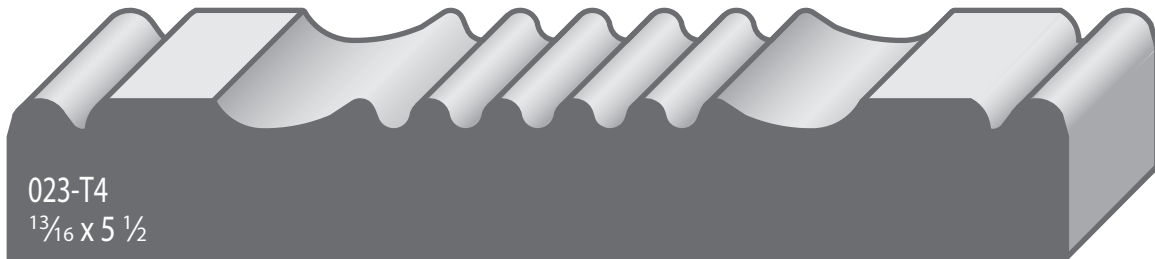
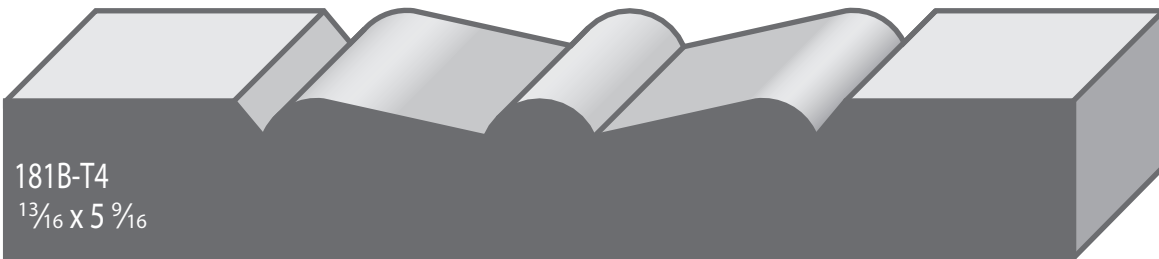

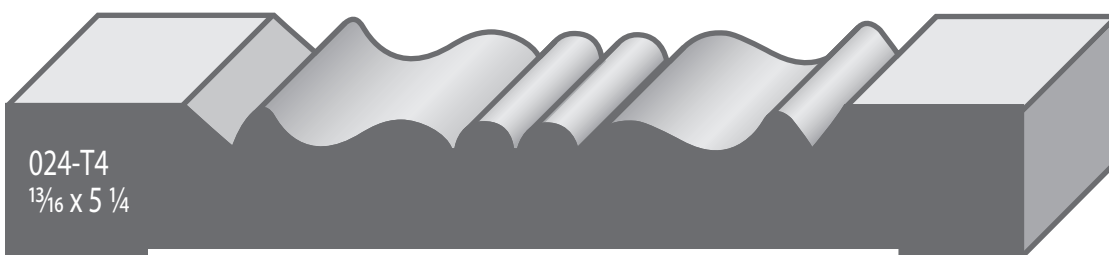
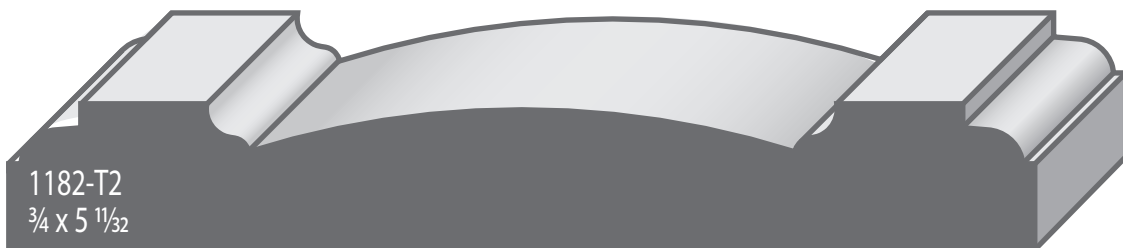
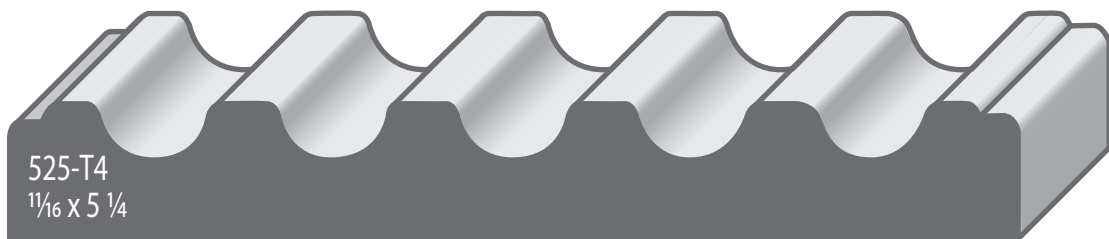
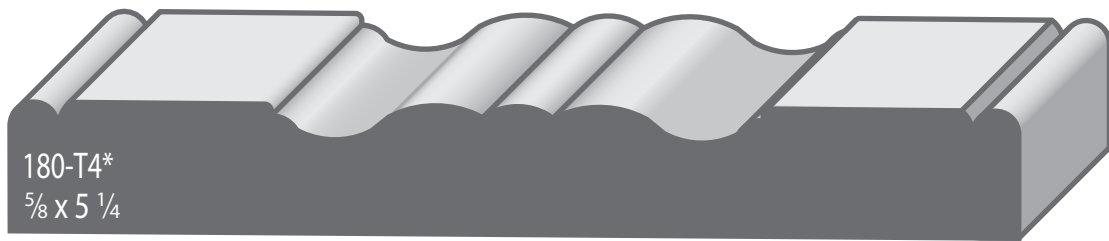
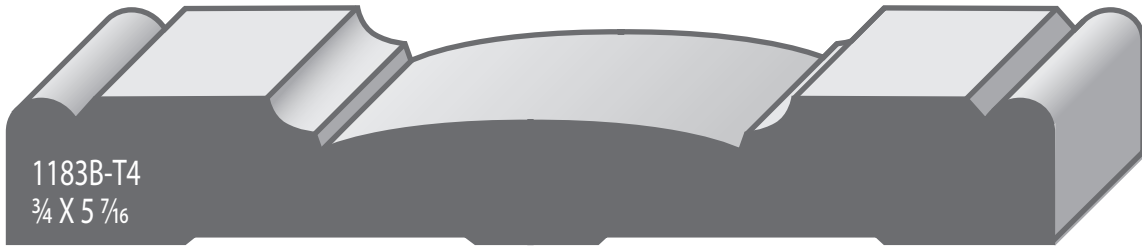

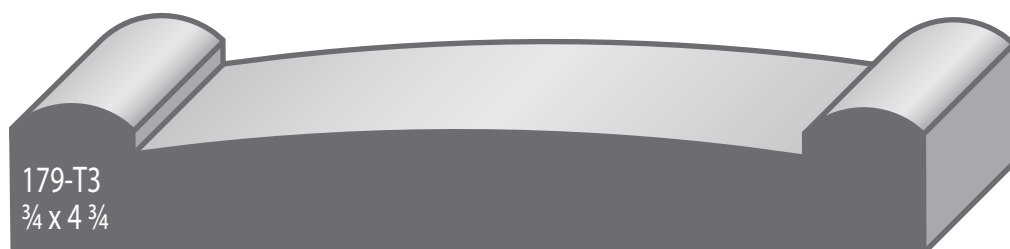
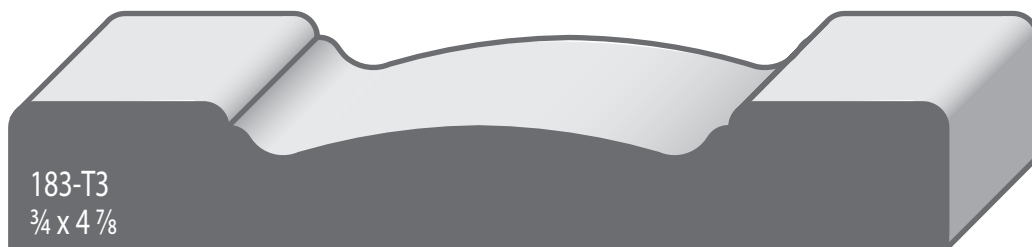
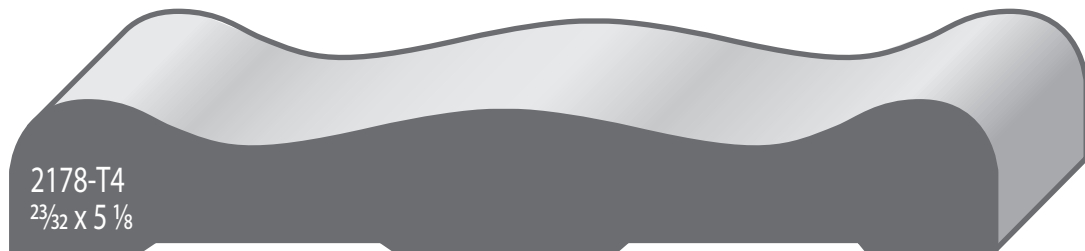
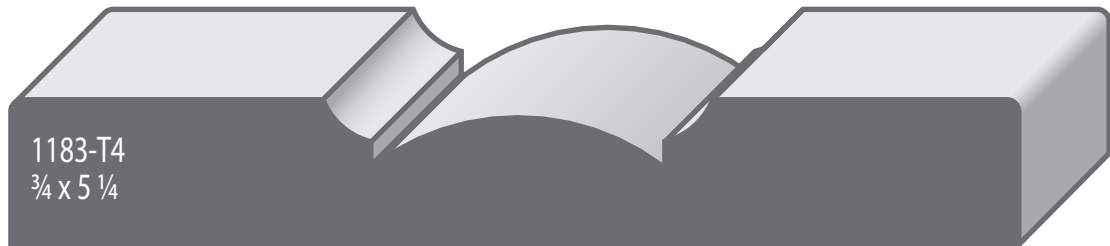

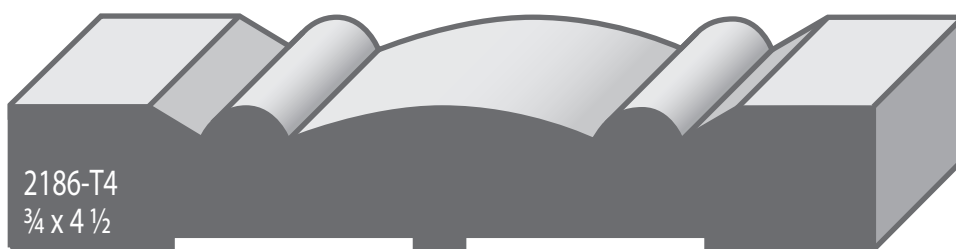
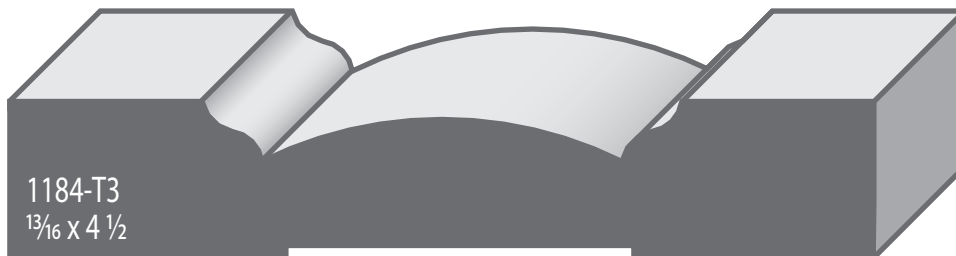
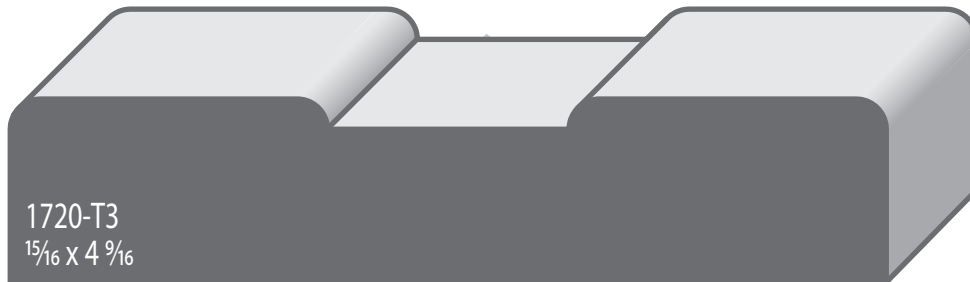
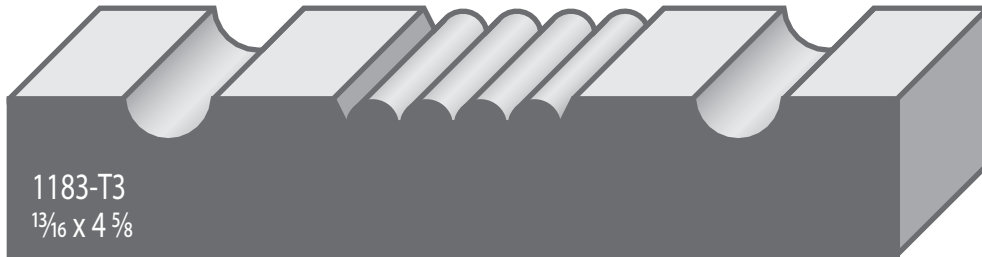

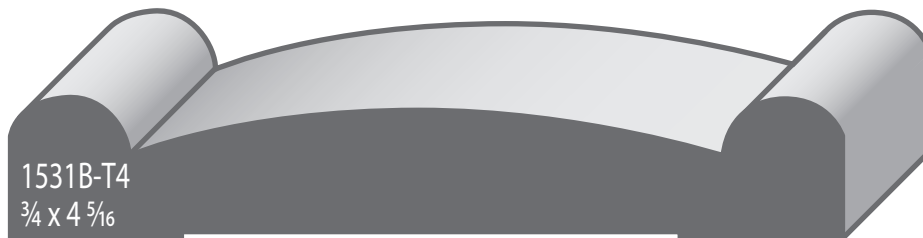
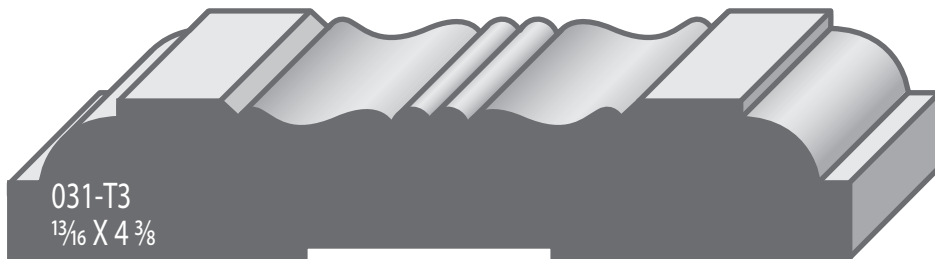
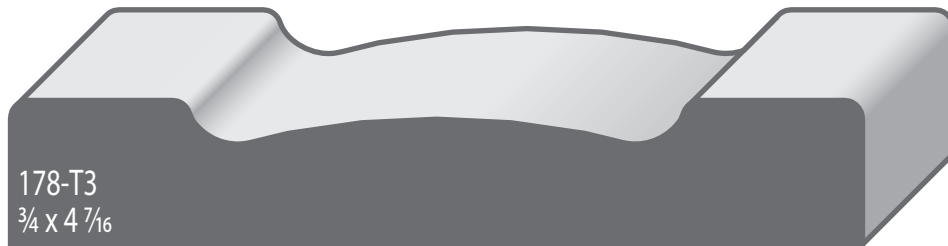
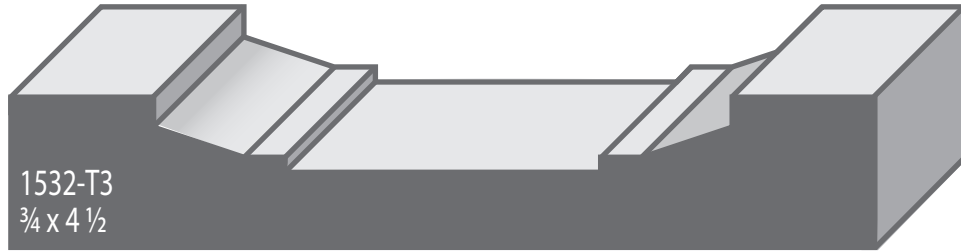

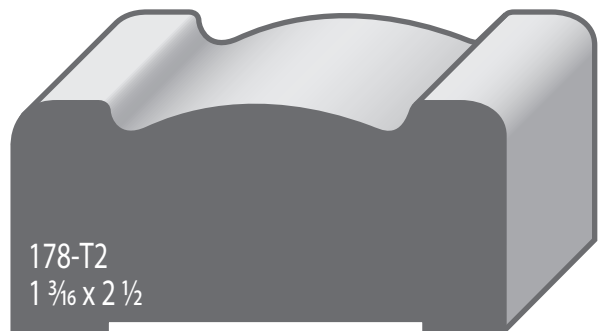
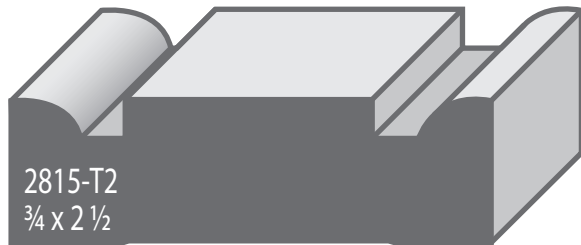
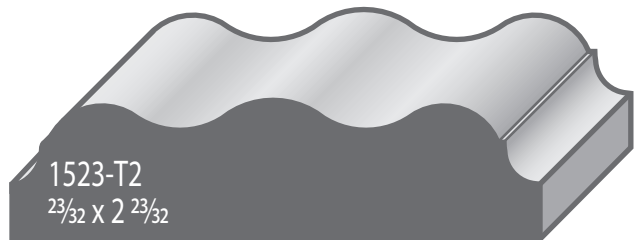
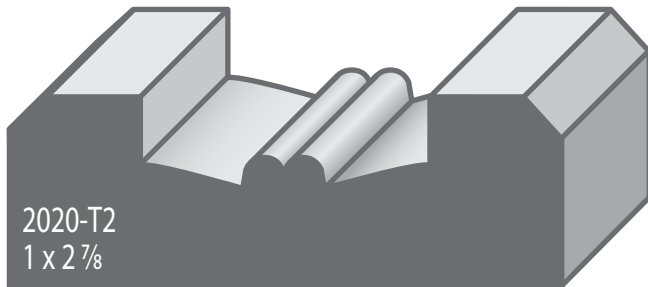
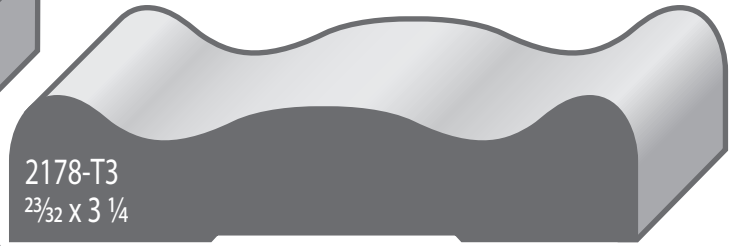

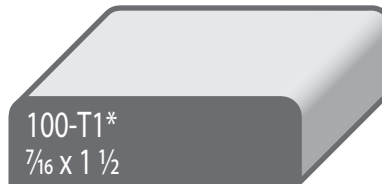
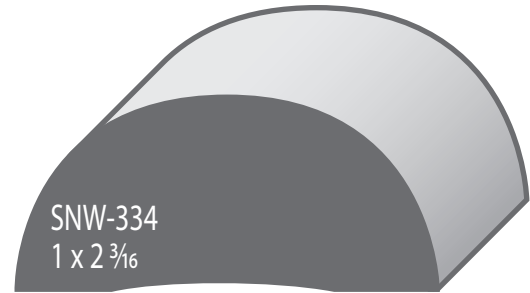
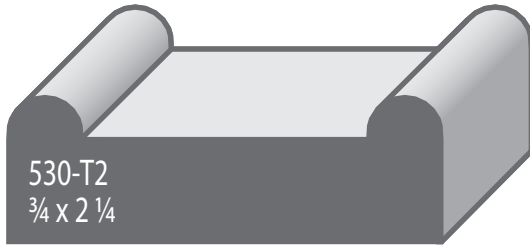
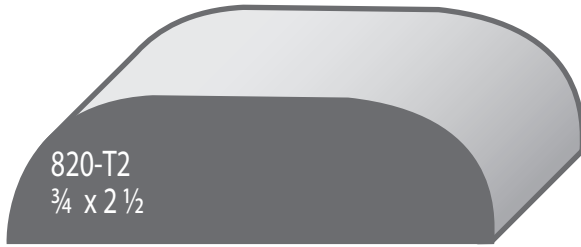

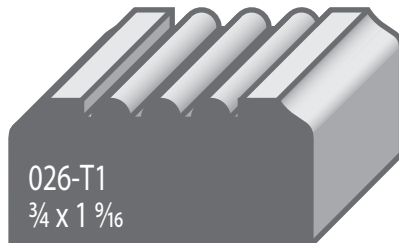
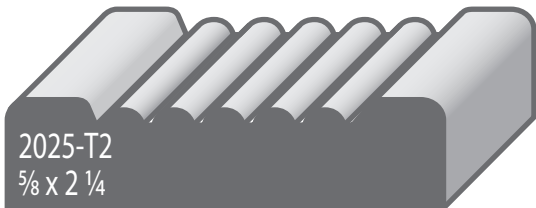
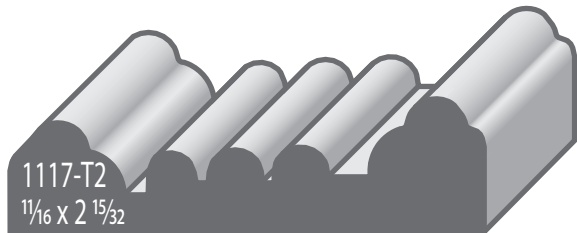
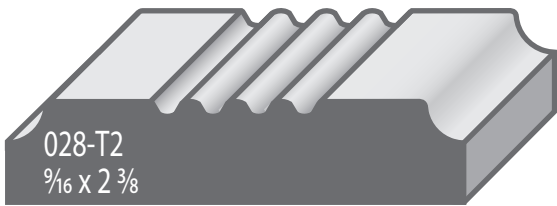
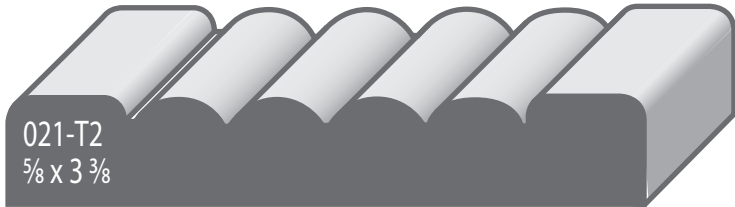
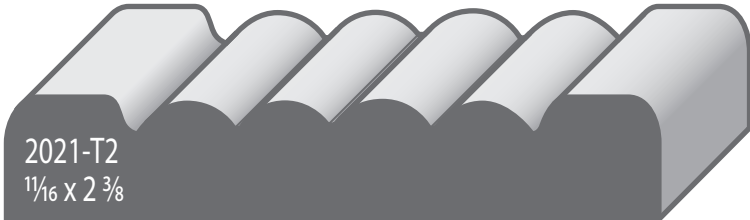

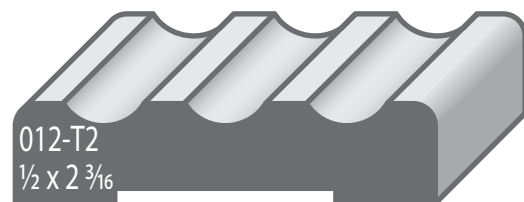
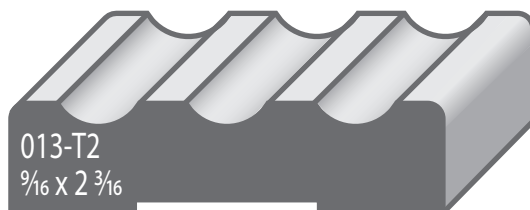
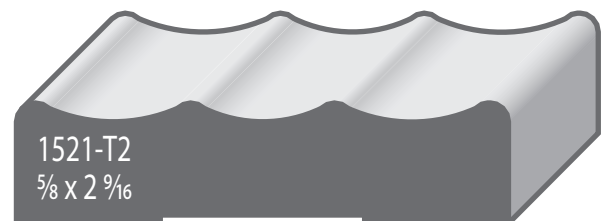
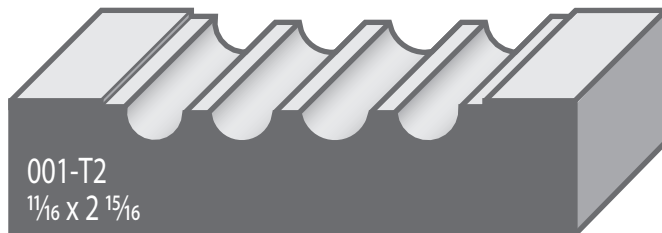
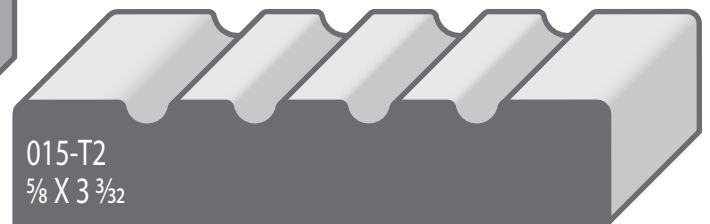
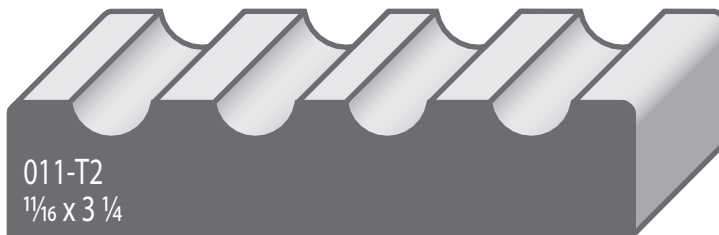
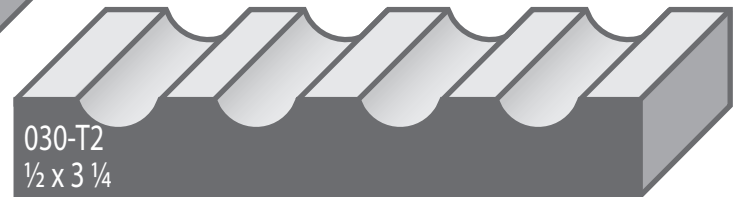
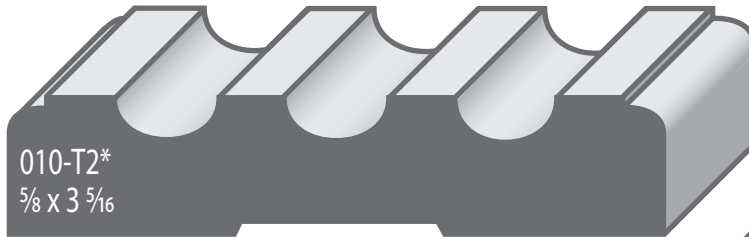
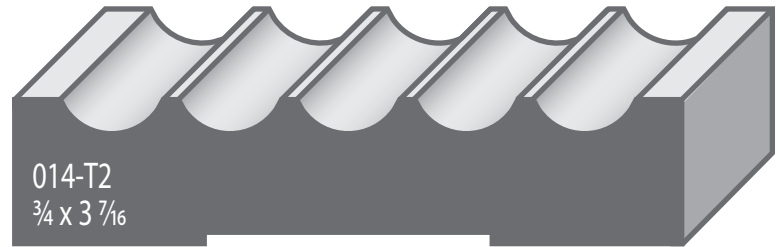
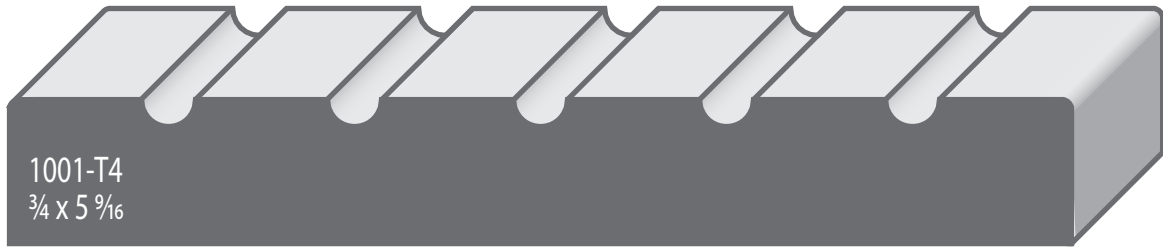

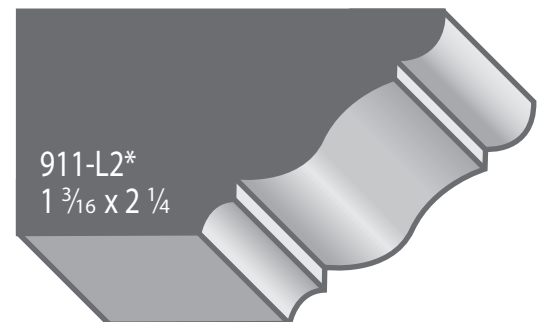
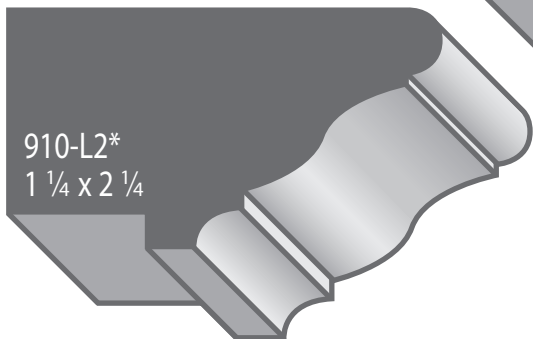
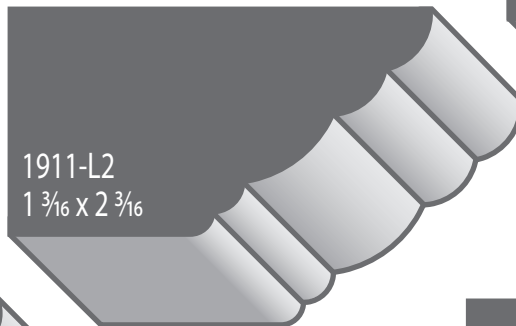
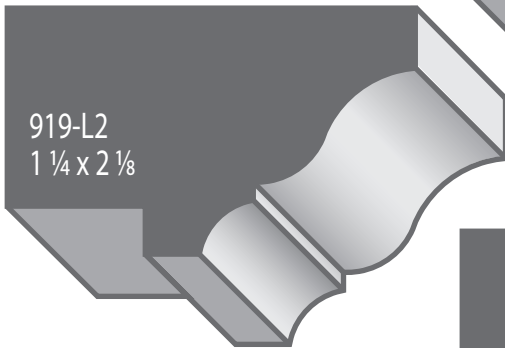
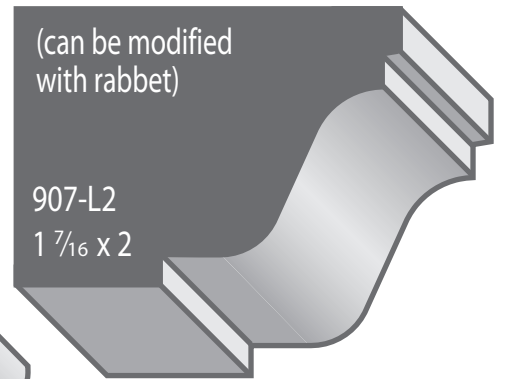
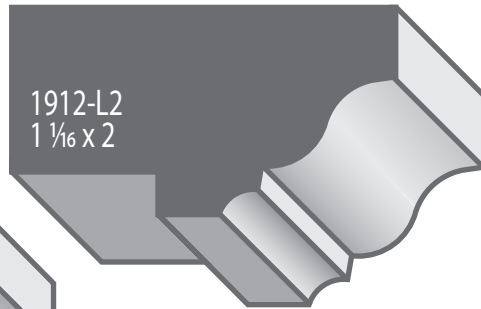
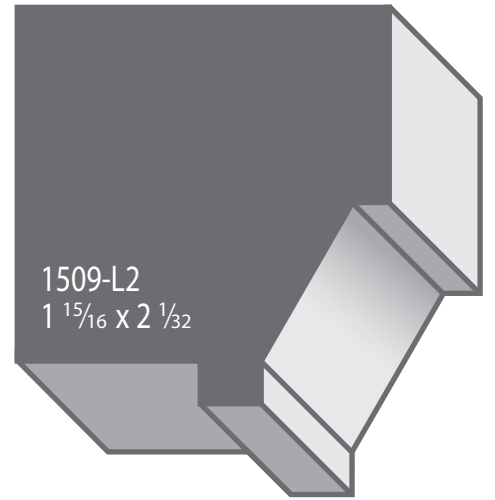
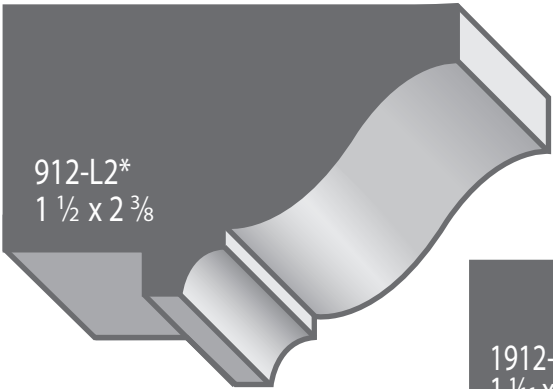
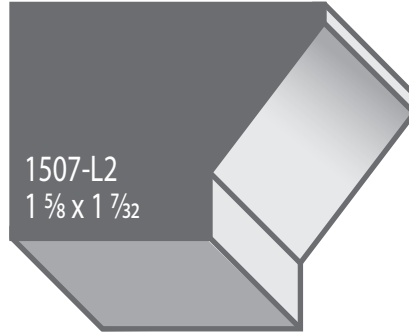
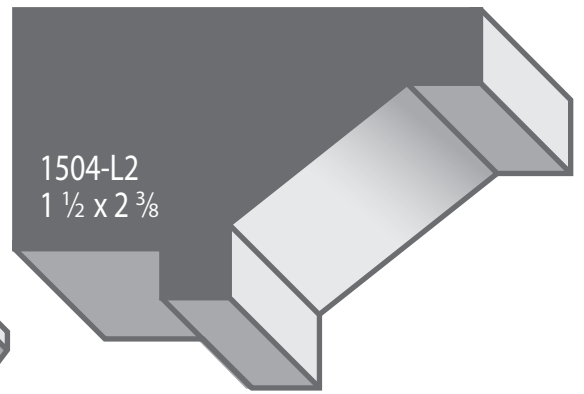
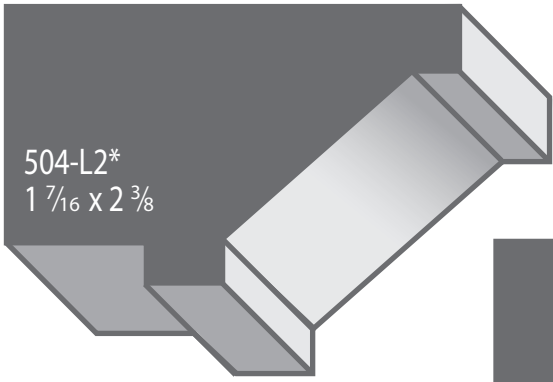

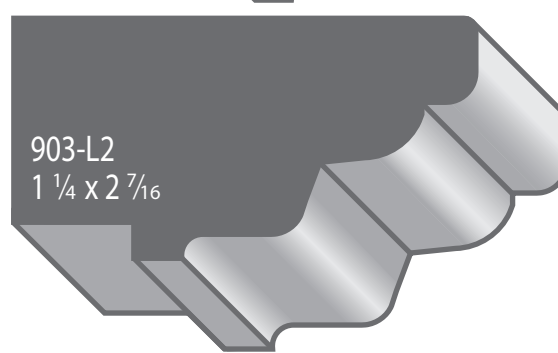
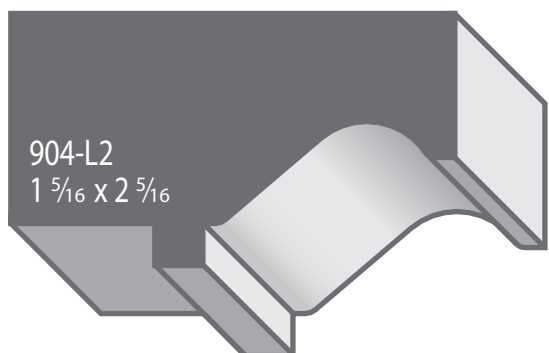
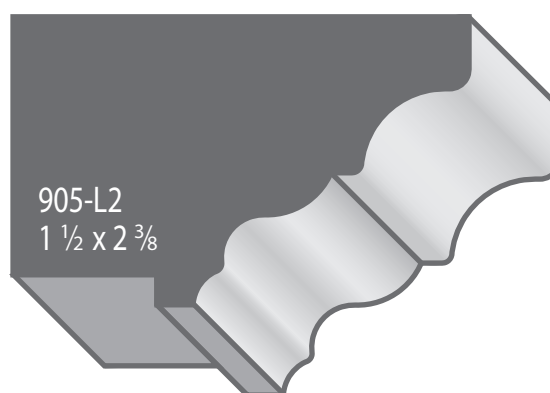
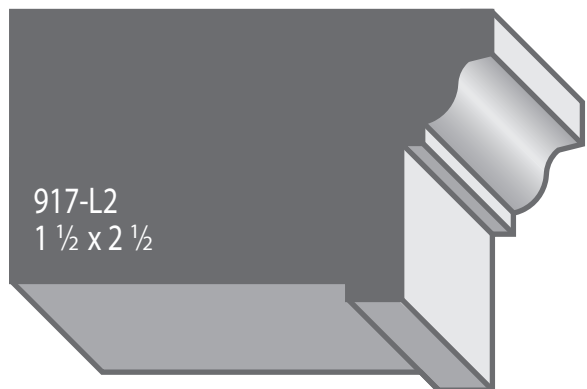
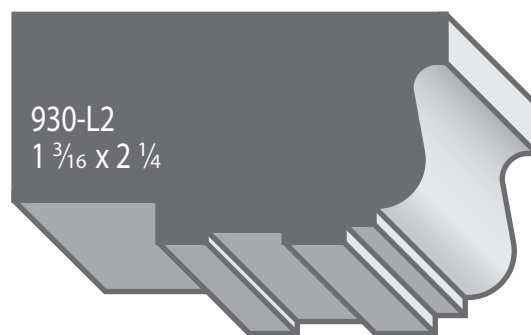
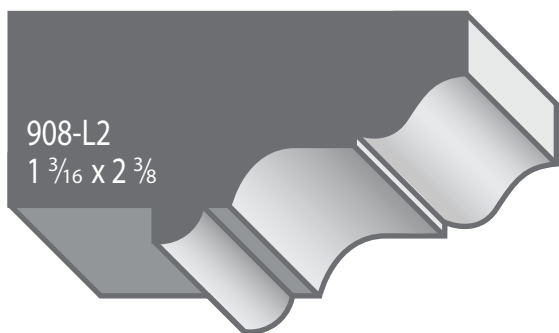
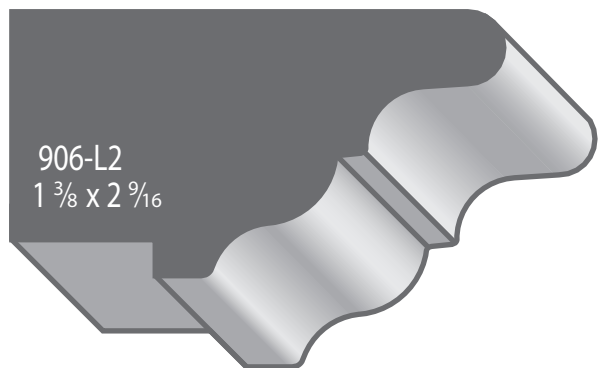
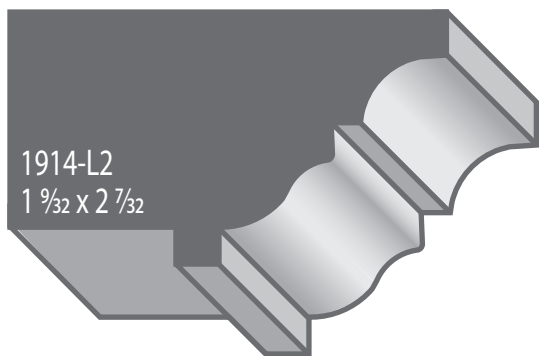

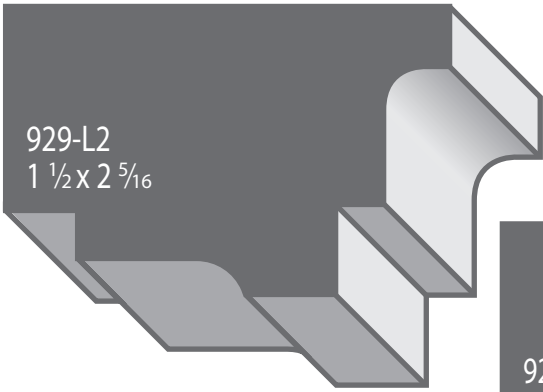

929-L2
1 1/2 x 2 5/16

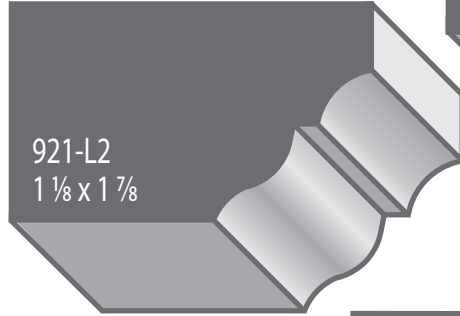

921-L2
1 1/8 x 1 7/8

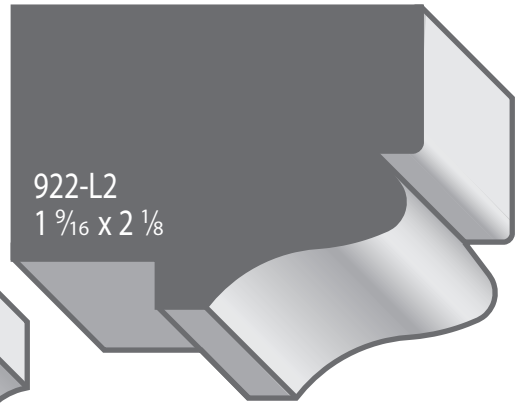

922-L2
1 9/16 x 2 1/8

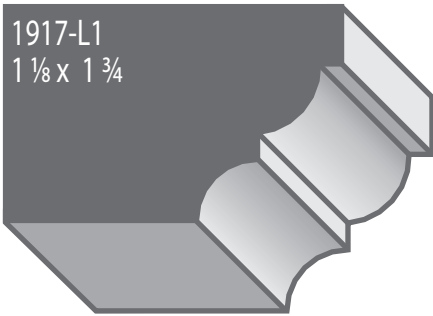

1917-L1
1 1/8 x 1 3/4

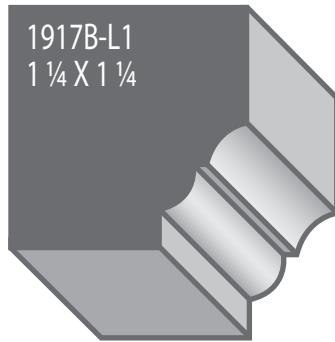

1917B-L1
1 1/4 x 1 1/4

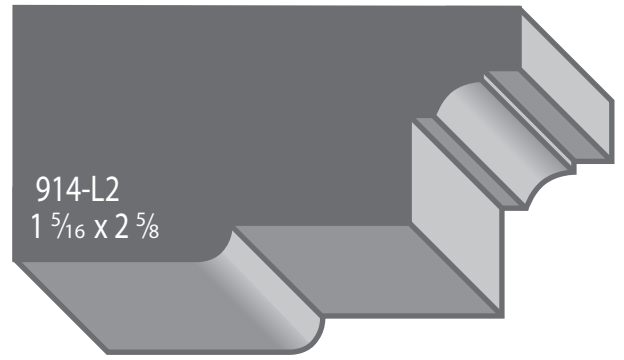

914-L2
1 5/16 x 2 5/8

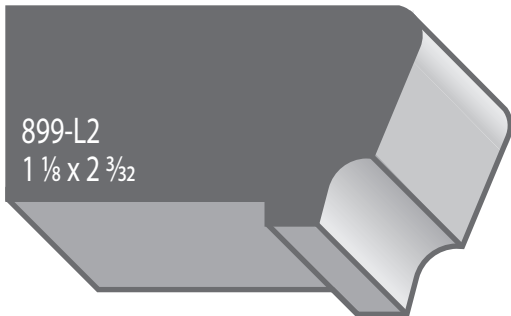

899-L2
1 1/8 x 2 3/32

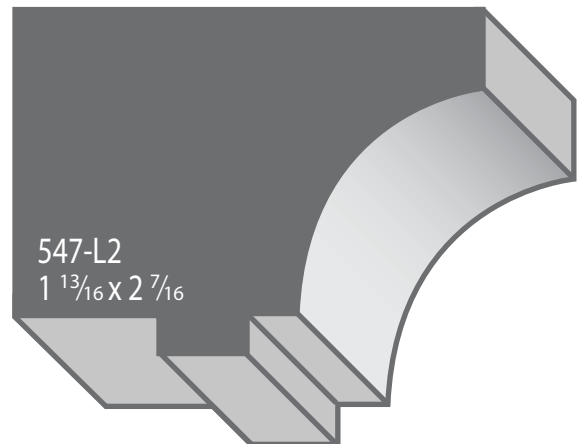

547-L2
1 13/16 x 2 7/16

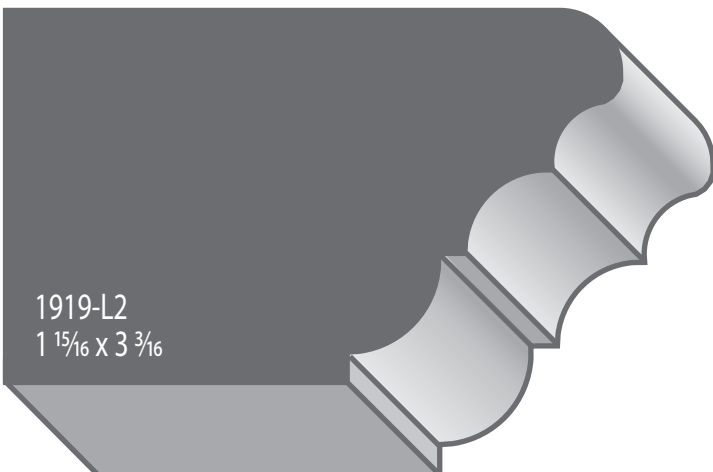

1919-L2
1 15/16 x 3 3/16



916-L2
1 3/4 x 2 1/4

