



Section B - Casings



McCOY MILLWORK

Custom Shop Services

For custom profiles pricing is determined by the chosen species of wood and quantity. Provide the following:

1. A sample or scale drawing of the profile.
2. Amount of moulding needed in Lineal Feet.
3. Preferred species of wood.
4. Preferred final finish (paint or stain).

Send us your information via email or come in for a quote. You can expect to hear from us regarding pricing in 2 days.
Manufacturing time varies: 2 days-2 weeks.

Profile #	Pg #	Profile #	Pg #	Profile #	Pg #	Profile #	Pg #
001 T2 Fluted Casing B-23		142 T2 Casing B-16		181 T4 Sym Casing B-20		409 S1 Stop B-32	
010 T2* Fluted Casingvv B-23		143 T2 Casing B-14		183 T3 Sym Casing B-20		410 T2 Casing B-15	
011 T2 Fluted Casing B-23		144 T2 Casing B-15		185b T2 Sym Casing B-14		411 T2* Casing B-13	
012 T2 Symmetrical Casing B-22		145 T3 Casing B-11		185 T2* Casing B-9		413 T2 Casing B-12	
021 T2 Reeded Casing B-23		148 T2 Casing B-8		187 D2 Sym Casing B-22		415 S1 Stop B-32	
022 T2 Casing B-13		149b T2 Casing B-11		191 T2 Casing B-15		416 T3 Casing B-4	
023 T4 Sym Casing B-19		149 T2 Casing B-9		193 T2 Casing B-15		417 S1* Stop B-32	
024 T4 Sym Casing B-20		150 T2* Casing B-12		194 T2 Casing B-15		419 S1 Stop B-32	
025 T2 Reeded Casing B-23		151 T3 Casing B-4		195 T2 Casing B-14		420 S1* Stop B-32	
026 T1 Reeded Casing B-23		152 T3 Casing B-4		248 P2 Casing B-17		422 S1 Stop B-32	
027 T2 Reeded Casing B-23		153 M2 Apron B-28		261 T1 Casing B-18		423 S1 Stop B-32	
030 T2 Fluted Casing B-23		153 T3 Casing B-4		262 T1* Casing B-18		424 P2 Misc/Apron B-28	
100 T1* Sym Casing B-22		155 T3* Casing B-6		263 T1 Casing B-18		424 S1 Stop B-32	
107 T1 Casing B-18		156 T2 Casing B-7		263 T2 Clamshell Casing B-18		427 P2 Apron B-28	
108 T1 Casing B-18		158 T2 Casing B-7		264b T2 Casing B-15		436 P1 Apron B-29	
109 T1 Casing B-18		158 T4 Casing B-3		264 T2 Casing B-13		444 T2* Casing B-12	
110 T1* Casing B-18		159 T3 Casing B-6		265 T2* Casing B-18		447 T2 Casing B-12	
111b T2 Casing B-10		162 B2 Casing B-16		266 T2 Casing B-13		448 T2 Casing B-8	
111 T2* Casing B-11		170b T2 Casing B-13		268 T2 Casing B-18		487 T2 Casing B-13	
112 T1* Casing B-17		170c T2 Casing B-13		269 M2 Apron B-28		488 T2 Casing B-11	
113 T2* Casing B-12		170 T2 Casing B-16		304 A2 Backband B-33		496 T3 Casing B-4	
114 BV Casing B-3		171b T2 Casing B-15		319 M1 Apron B-29		503 S1* Parting Bead B-27	
115 T2* Casing B-16		171 T2 Casing B-14		356 T2* Casing B-16		504 L2* Lintel B-24	
116 T2 Casing B-10		172 T2 Casing B-12		357 T2 Casing B-16		528 PV Apron B-28	
117 T2 Casing B-13		173b T2 Casing B-10		358 T2 Casing B-16		529 T2 Sym Casing B-22	
118 T2 Casing B-12		173 T2 Casing B-9		359 T2 Casing B-14		530 T2 Sym Casing B-22	
119 T3 Casing B-6		174b T2 Casing B-12		384 BV Apron B-29		533 T2 Casing B-10	
120 M4 Apron B-29		174 T2 Casing B-10		386 T3 Casing B-5		534 T2 Casing B-11	
120 T2 Casing B-12		175 T2 Casing B-13		387 T2 Casing B-11		535 T2* Casing B-9	
121 T2 Casing B-11		176 T2 Casing B-9		388b T2 Casing B-15		536 T3 Casing B-5	
130 T2* Casing B-18		177 T3 Casing B-6		388c T2 Casing B-15		547 L2 Lintel B-26	
133 T2 Casing B-18		178 T3 Sym Casing B-21		388d T2 Casing B-15		620 T2 Casing B-14	
138 T4 Casing B-4		179 T3 Sym Casing B-21		388 T2 Casing B-16		717 D2 Apron B-28	
139 T2 Casing B-13		180 T4* Sym Casing B-19		390 T2 Casing B-8		726 P2 Apron B-28	
140 T2* Casing B-14		181b T4 Casing B-19		391 T1 Casing B-17		746 P2 Apron B-28	
141 T2 Casing B-15, B-16		181 D4 Sym Casing B-19		392.2 T2 Step Casing B-12		750 T2 Casing B-13	



Profile #	Pg #	Profile #	Pg #	Profile #	Pg #	Profile #	Pg #
751 MV Apron B-28		956 S1 Parting Bead B-27		1156 T2 Casing B-10		3120 T2 Casing B-7	
753 D4 Architrave B-30		984 A1 Backband B-33		1157 T2 Casing B-9		3122 T2* Casing B-9	
770 M3 Apron B-29		985 A1 Backband B-33		1158 T2 Casing B-7		3133 T2 Casing B-8	
772 M4 Apron B-29		1001 T4 Fluted Casing B-23		1159 T2 Casing B-8		3134 T4 Casing B-5	
781 P2 Casing B-14		1020 A1 Backband B-33		1171 T2 Casing B-10		3135 T3 Casing B-5	
803 T2 Sym Casing B-22		1021 A1* Backband B-33		1172 T2 Casing B-15		3136 T4 Casing B-3	
804 T3 Sym Casing B-21		1022 A1* Backband B-33		1173 T2 Casing B-11		3137 T4 Casing B-6	
806 T2 Casing B-14		1024 A1 Backband B-33		1174 T2 Casing B-14			
807 P2 Apron B-28		1025 A1* Backband B-33		1175 T2 Casing B-14			
808 T2 Casing B-16		1026 A1 Backband B-33		1181 T4 Sym Casing B-19			
821 T2 Casing B-9		1027 A1 Backband B-32, B-33		1182 T4 Sym Casing B-19			
885 MV Sill B-31		1028 P2 Backband B-33		1183 T3 Sym Casing B-20			
886 MV Sill B-31		1029 A1* Backband B-33		1183 T4 Sym Casing B-20			
887 MV Sill B-31		1039 T2 Casing B-16		1184 T3 Sym Casing B-21			
888 MV* Sill B-31		1104 T2 Casing B-15		1193 T2 Casing B-14			
889 MV Sill B-31		1113 T2 Casing B-11		1203 T2 Casing B-16			
894 D2 Sym Casing B-22		1114 T3 Casing B-7		1211 T4 Casing B-3			
900 L2 Lintel B-26		1117 T2 Reeded Casing B-23		1212 T4 Casing B-3			
901 L2 Backband B-32		1118 T2 Casing B-15		1213 T3 Casing B-5			
902 L2 Lintel B-25		1120 T2 Casing B-16		1261 T1 Casing B-18			
903 L2 Lintel B-25		1121 T2 Casing B-11		1264 T2 Casing B-18			
904 L2 Lintel B-25		1122 T2 Casing B-12		1266 T2 Casing B-15			
905 L2 Lintel B-25		1123 A1 Backband B-33		1318 A2 Backband B-32			
906 L2 Lintel B-25		1124 T2 Casing B-9		1319 M1 Apron B-29			
907 L2 Lintel B-24		1125 A1 Backband B-32		1438 T2 Colonial Casing B-11			
908 L2 Lintel B-25		1126 A1 Backband B-33		1439 T2 Colonial Casing B-10			
909 L2 Lintel B-25		1127 A1 Backband B-33		1444 T3 Casing B-5			
909 M1 Apron B-28		1128 A1 Backband B-33		1460 T2 Casing B-16			
910 L2* Lintel B-24		1129 A1 Backband B-33		1461 T2 Casing B-12			
911 L2* Lintel B-24		1130 T2 Casing B-18		1463 T2 Casing B-10			
912 L2* Lintel B-24		1131 T1 Casing B-18		1504 L2 Lintel B-24			
914 L2 Lintel B-26		1132 T2 Sanitary Casing B-18		1507 L2 Lintel B-24			
915 L3 Lintel B-27		1139 T2 Casing B-7		1509 L2 Lintel B-24			
916 L2 Lintel B-26		1139 T3 Casing B-3		1521 T2 Sym Casing B-22			
917 L2 Lintel B-25		1139 TV Casing B-8		1527 T3 Sym Casing B-21			
919 L2 Lintel B-24		1140 T2 Casing B-15		1528 T4 Sym Casing B-19			
921 L2 Lintel B-27		1141 T2 Casing B-16		1529 T4 Sym Casing B-19			
922 L2 Lintel B-26		1142 T2 Casing B-14		1560 T3 Casing B-6			
929 L2 Lintel B-26		1145 T2 Casing B-13		1570 T3 Sym Casing B-21			
930 L2 Lintel B-25		1146 T2 Casing B-14		1804 T2 Casing B-16			
931 M2 Apron B-28		1148 T2 Casing B-13		1911 L2 Lintel B-24			
948 S1 Bead B-27		1149 T2 Casing B-13		1912 L2 Lintel B-24			
949 S1 Bead B-27		1150 T2 Casing B-10		1913 L2 Lintel B-26			
950 S1* Parting Bead B-27		1151 T2 Casing B-7		1914 L2 Lintel B-25			
953 S1 Bead B-27		1152 T2 Casing B-8		1916 L2 Lintel B-26			
954 M1 Bead B-27		1153 T2 Casing B-8		1919 L2 Lintel B-27			
955 S1* Parting Bead B-27		1154 T2 Casing B-7		1922 A1 Backband B-33			

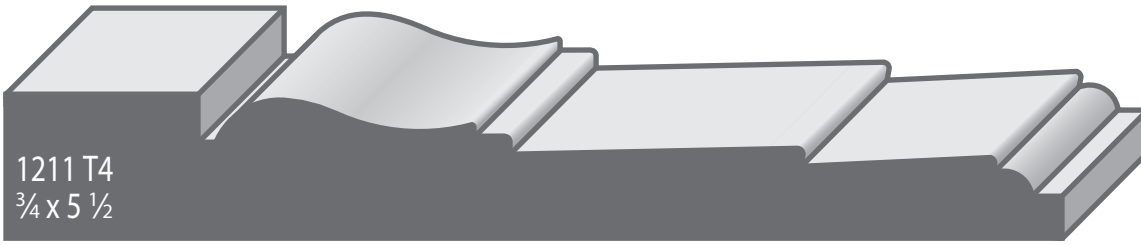

1211 T4
 $\frac{3}{4} \times 5 \frac{1}{2}$

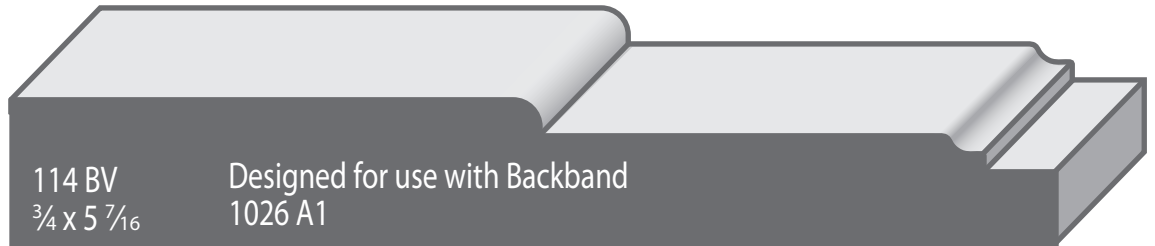

114 BV
 $\frac{3}{4} \times 5 \frac{7}{16}$

Designed for use with Backband
1026 A1

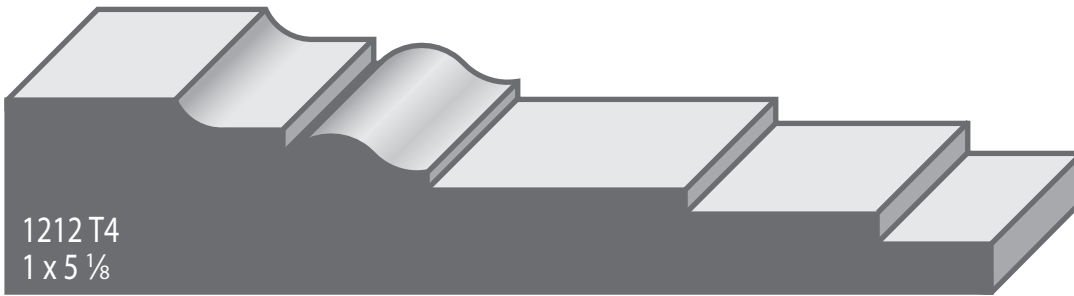

1212 T4
 $1 \times 5 \frac{1}{8}$

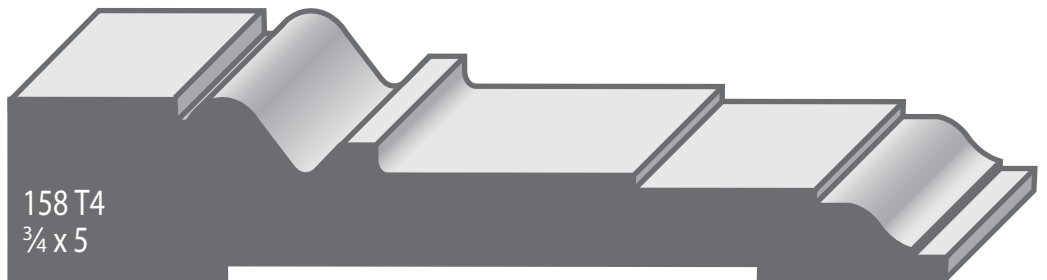

158 T4
 $\frac{3}{4} \times 5$



1139 T3
 $\frac{3}{4} \times 4 \frac{29}{32}$

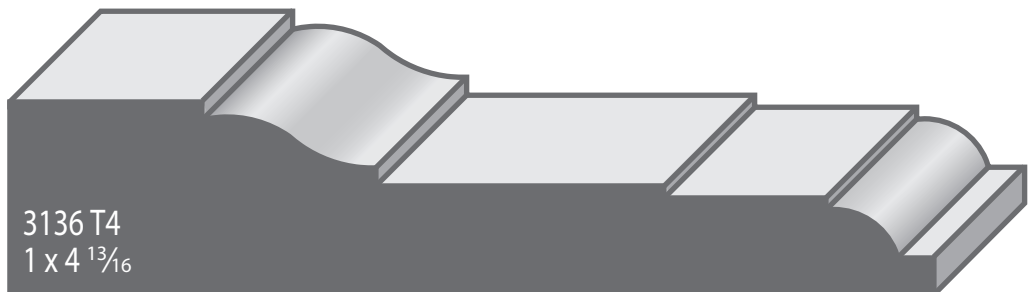

3136 T4
 $1 \times 4 \frac{13}{16}$

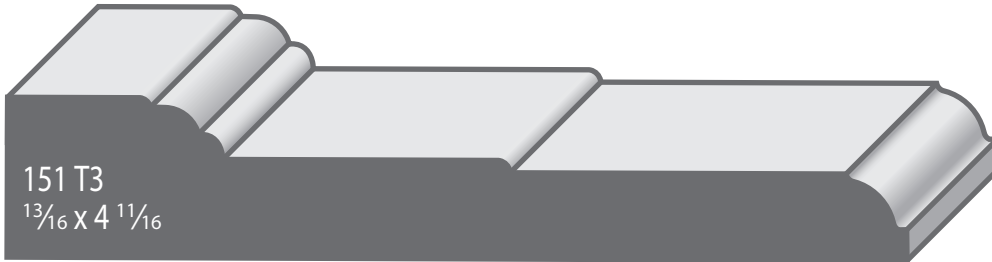
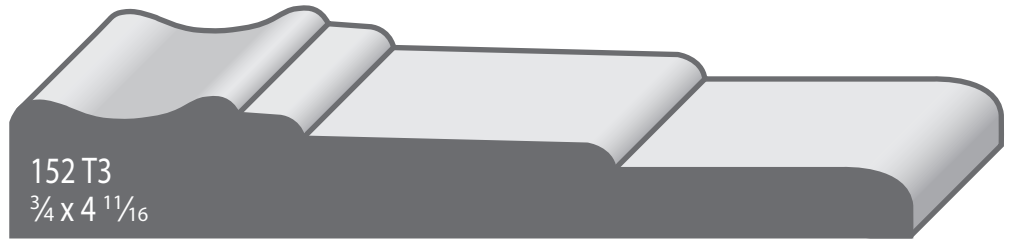
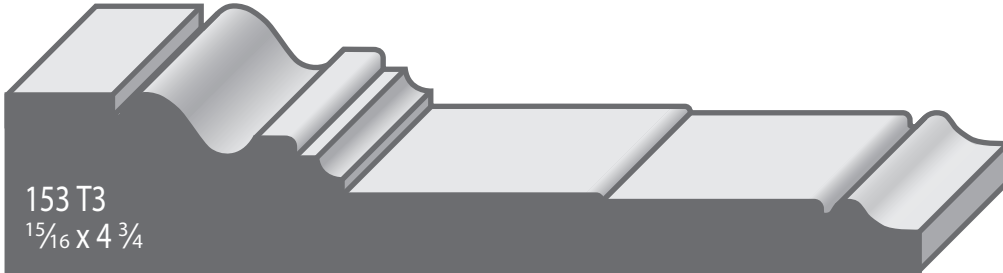
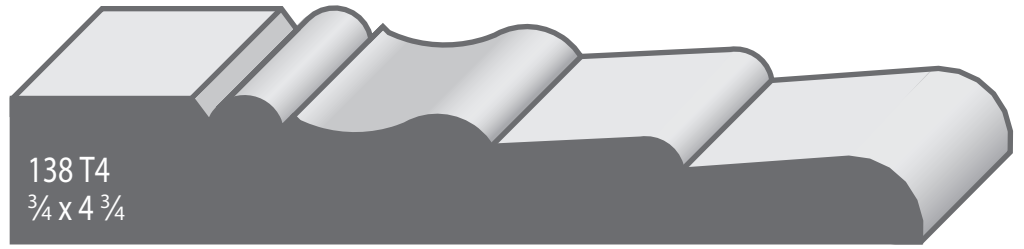



CASING

B-5

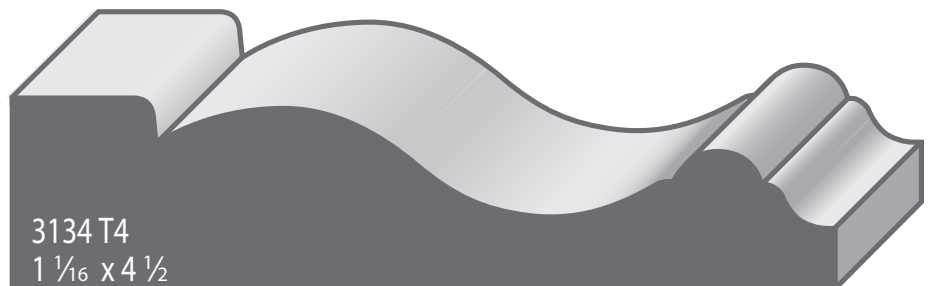
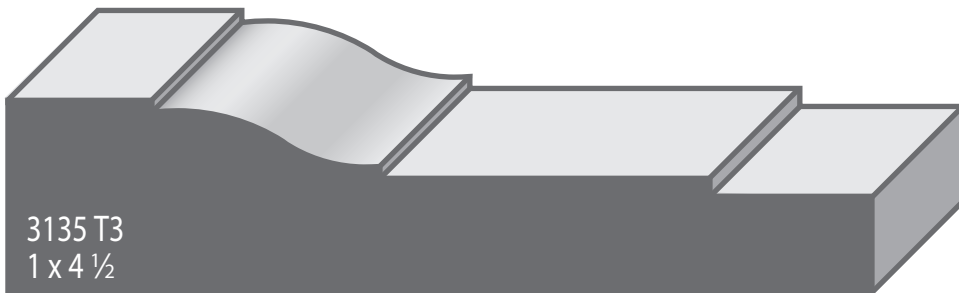
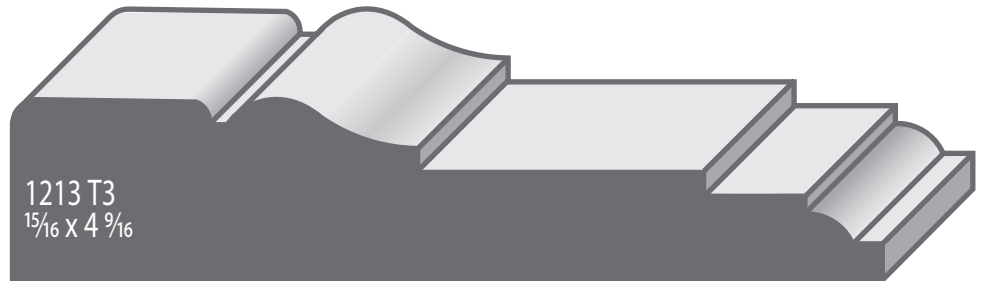
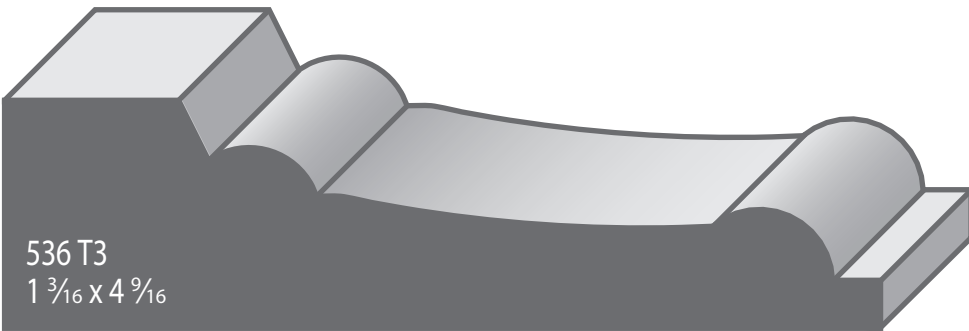
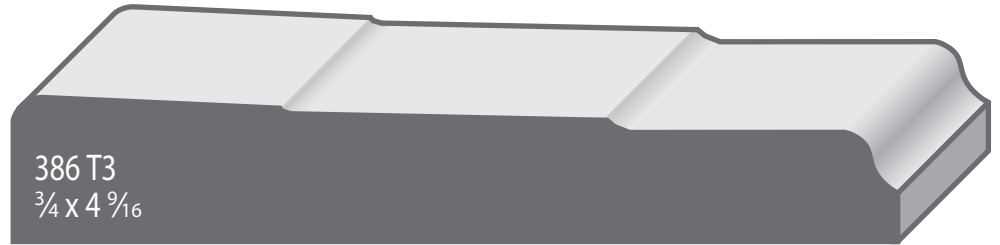
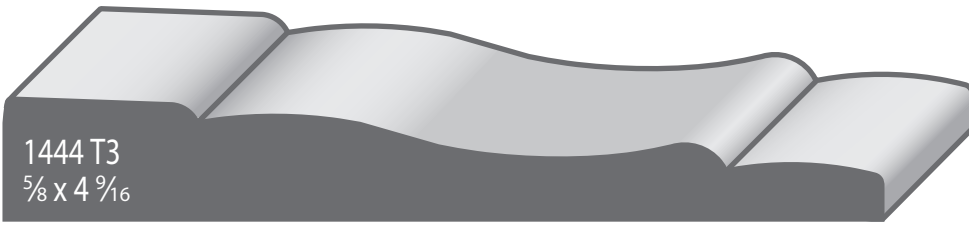

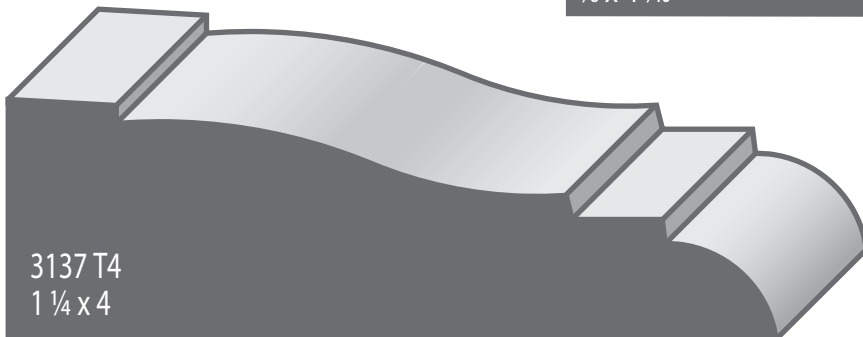
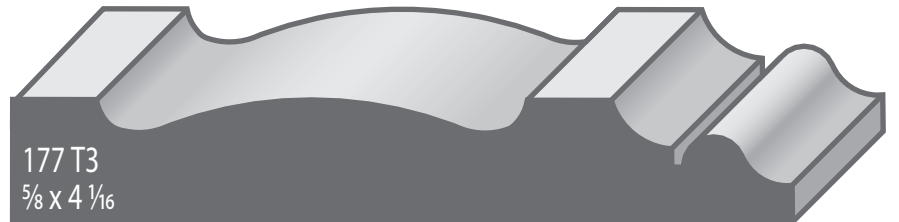
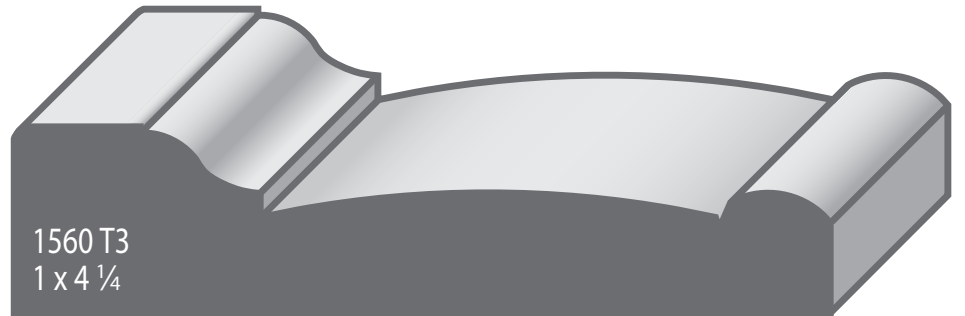
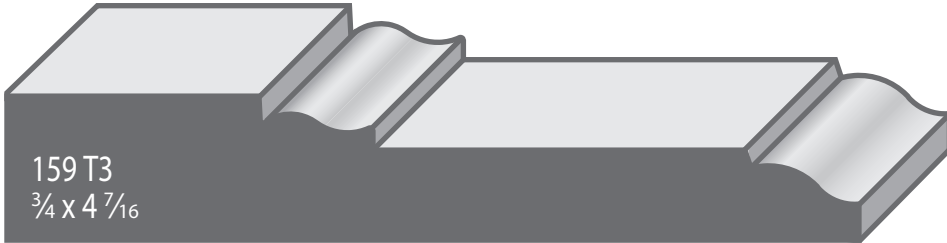
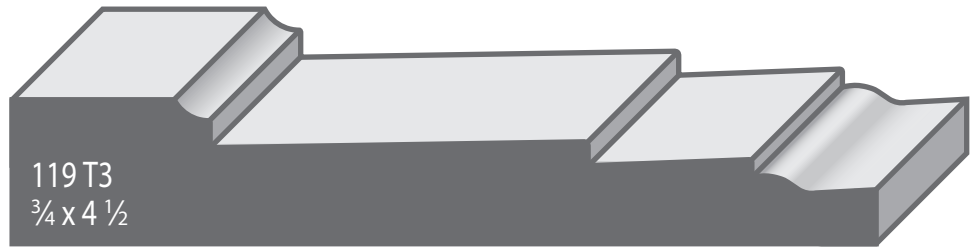

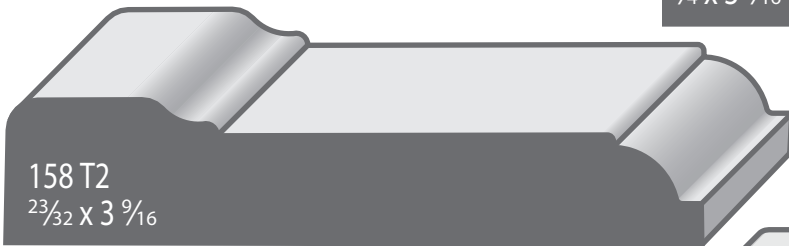
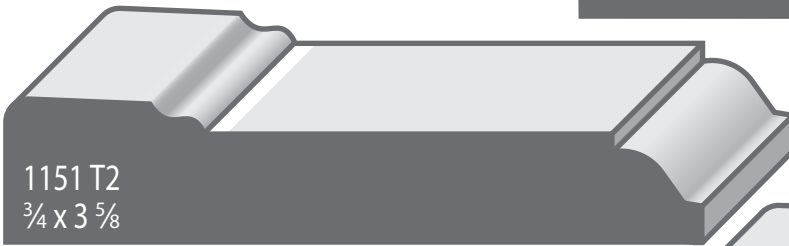
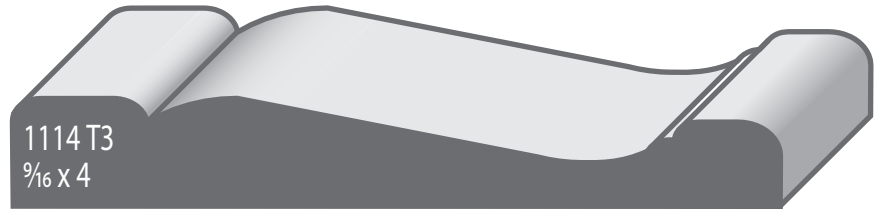
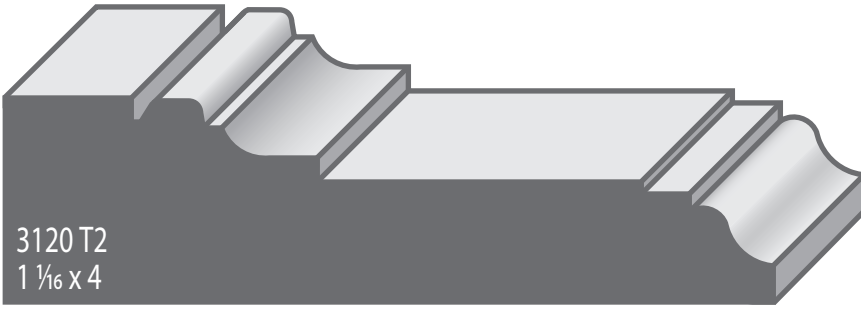

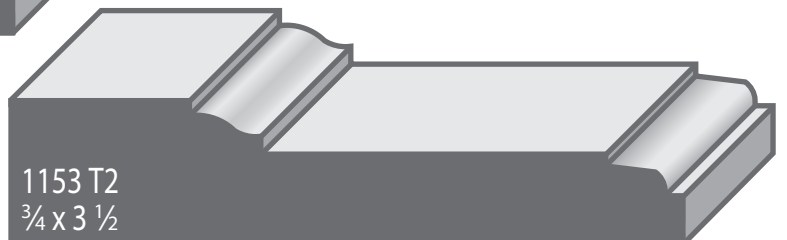
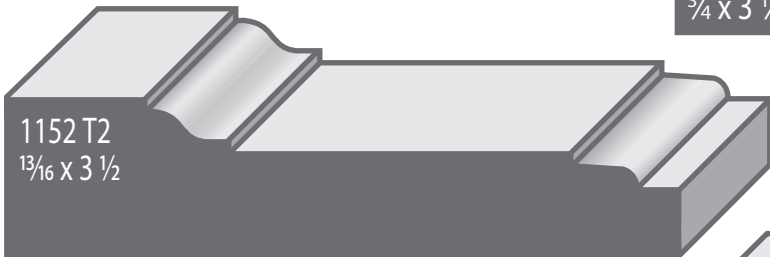
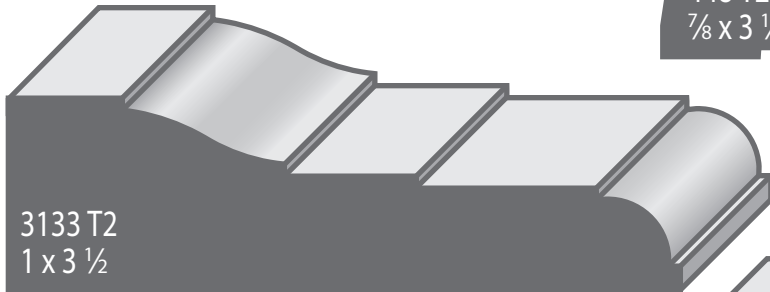
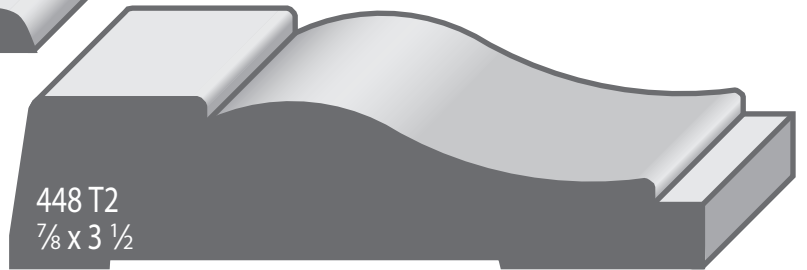
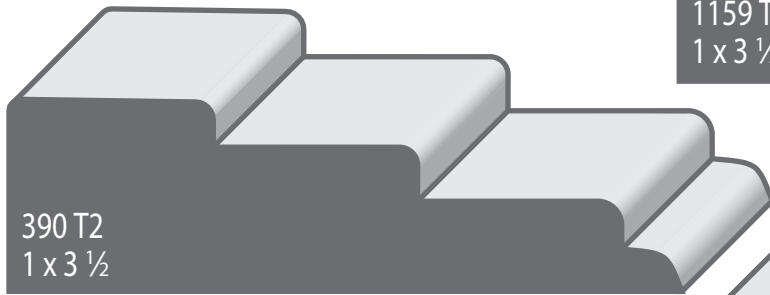
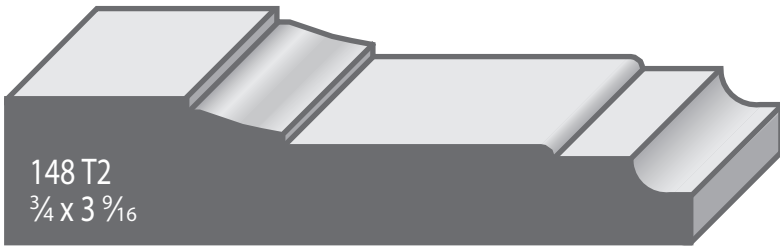

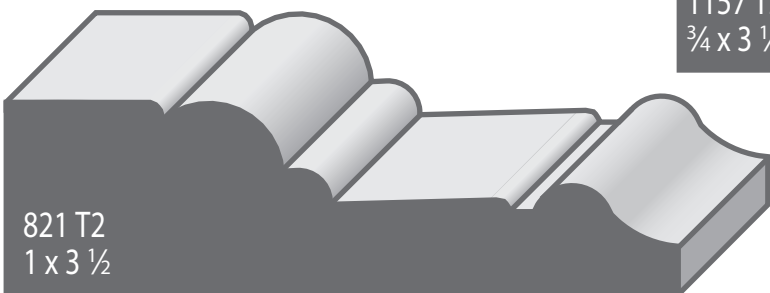
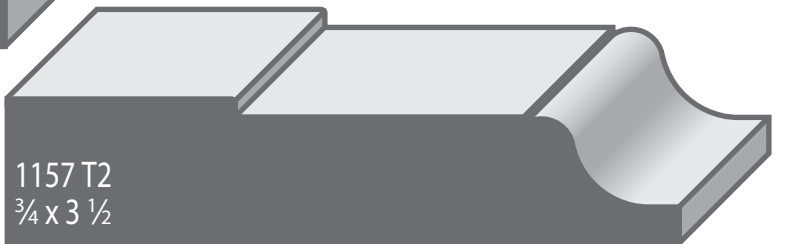
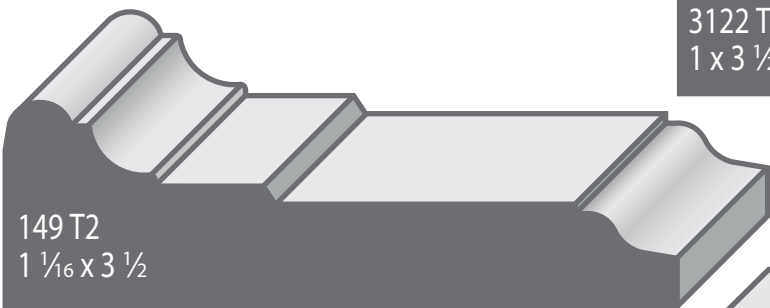
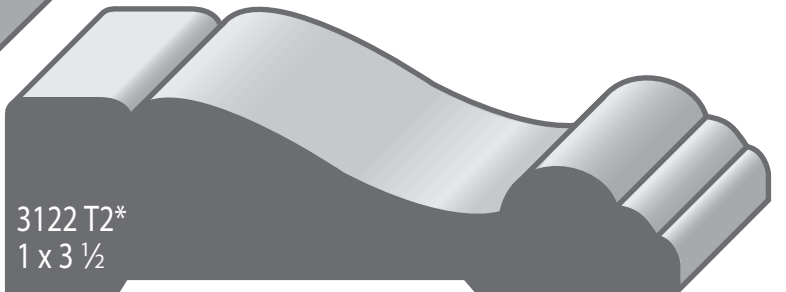
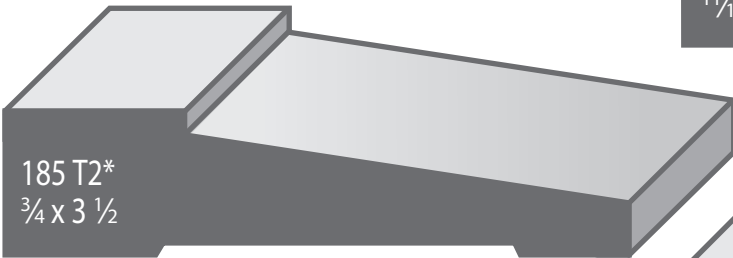
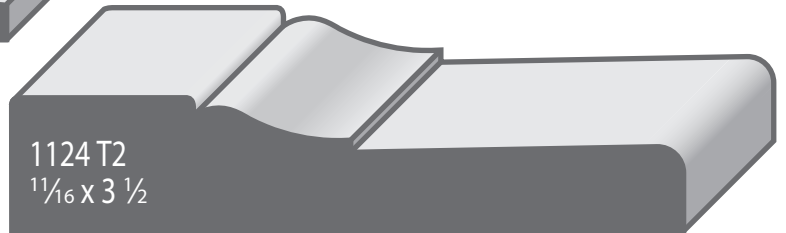
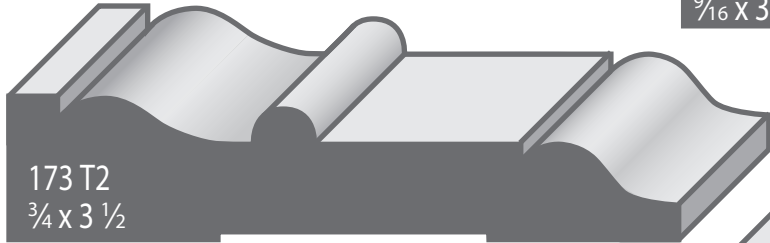
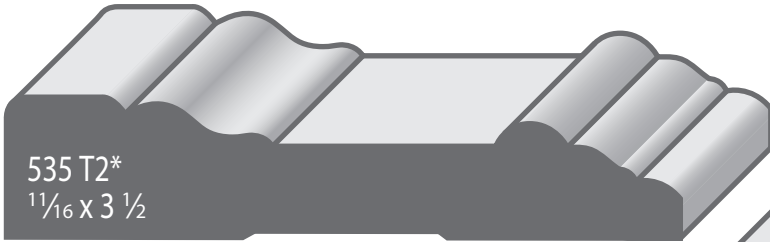

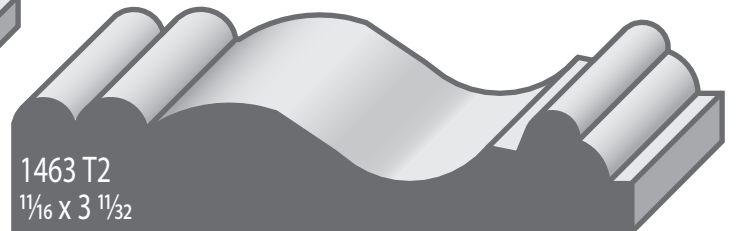
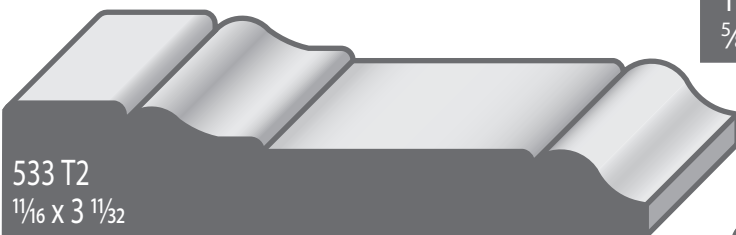
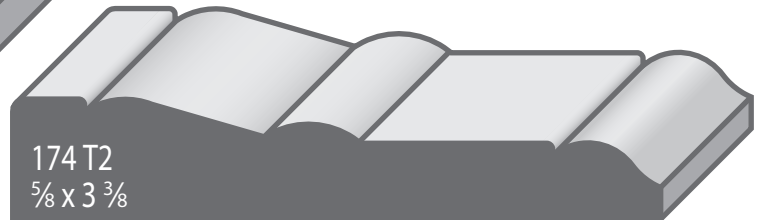
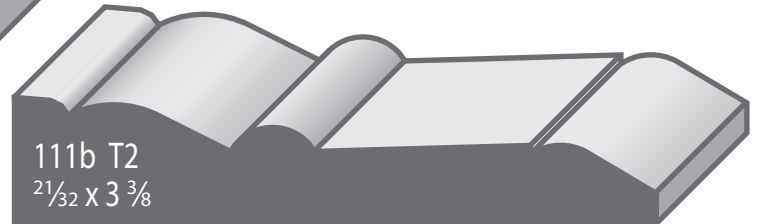
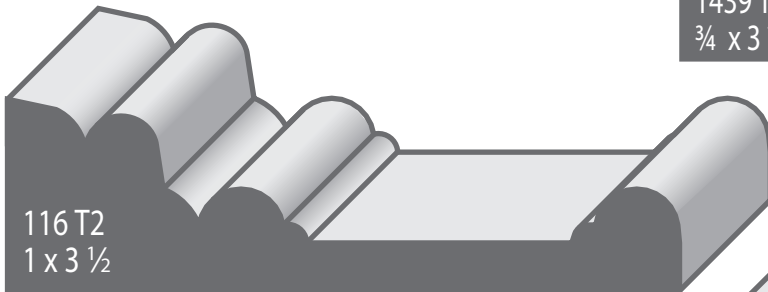
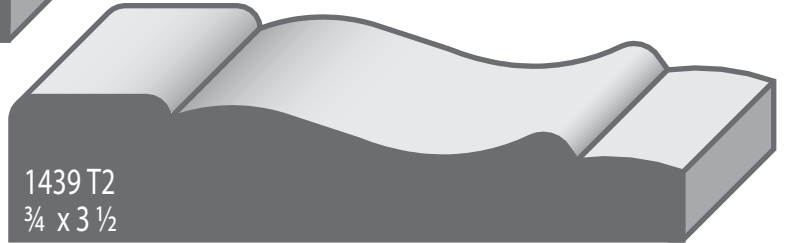
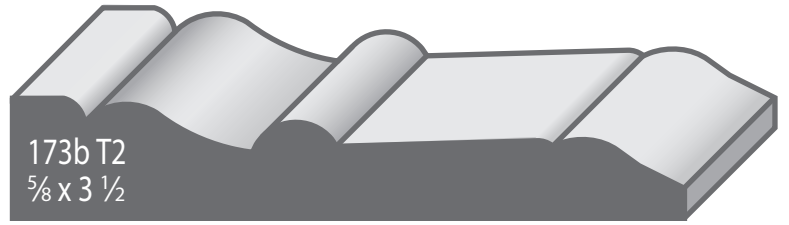

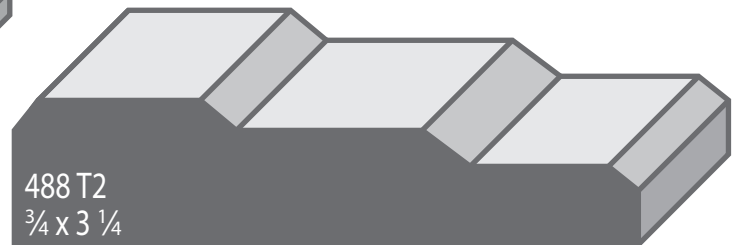
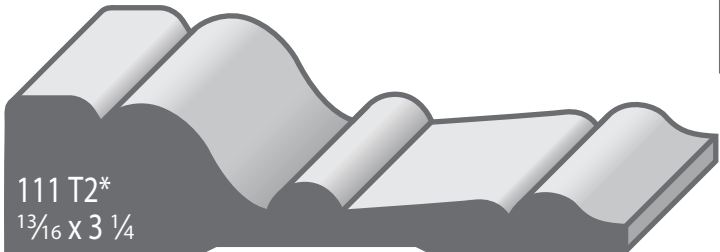
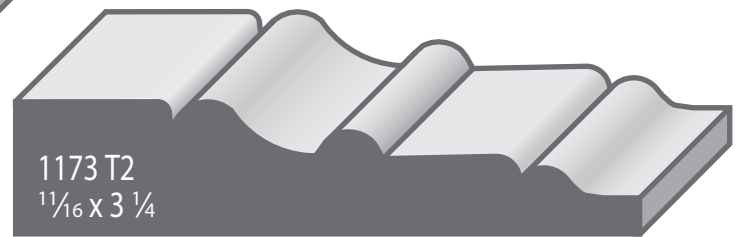
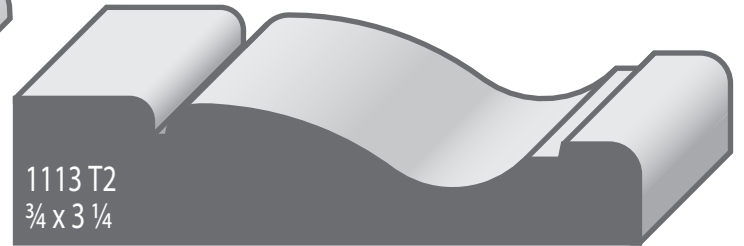
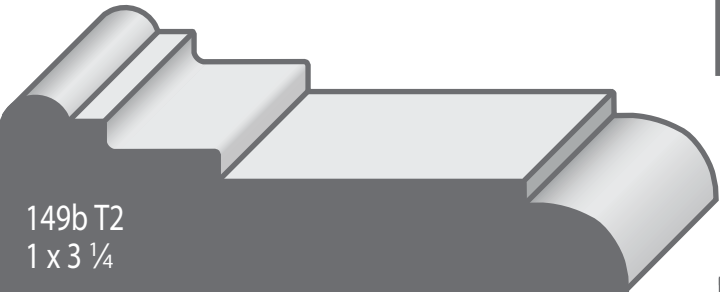
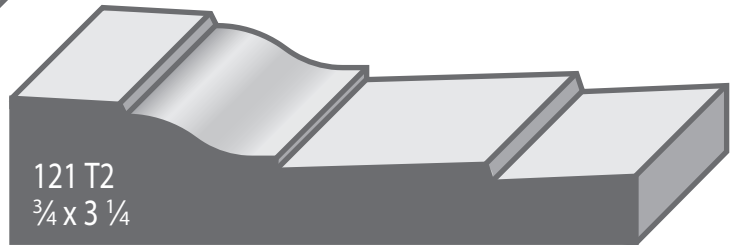
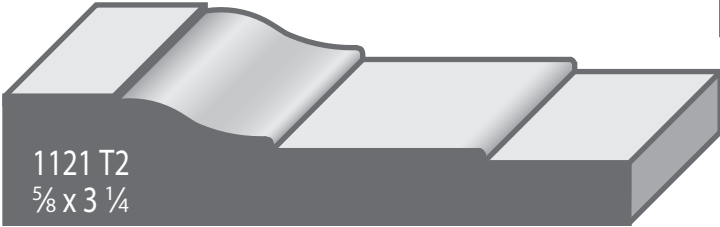
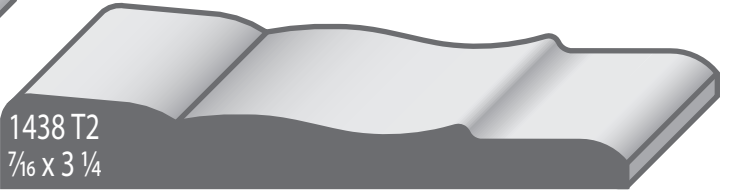
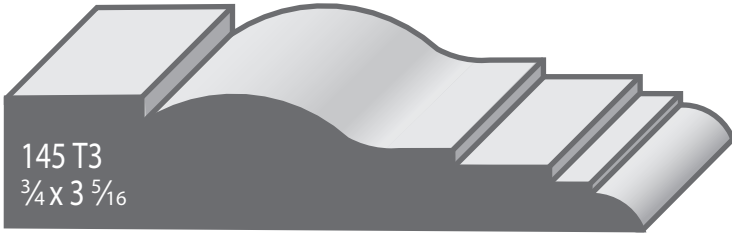

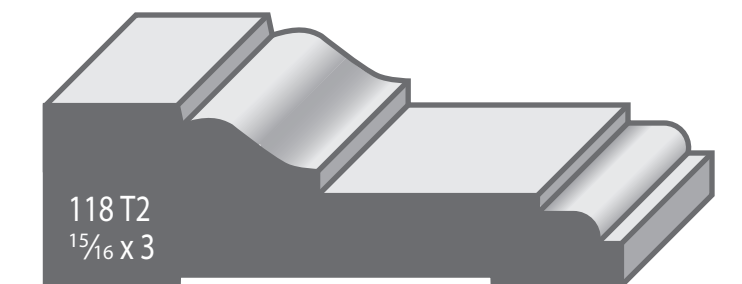
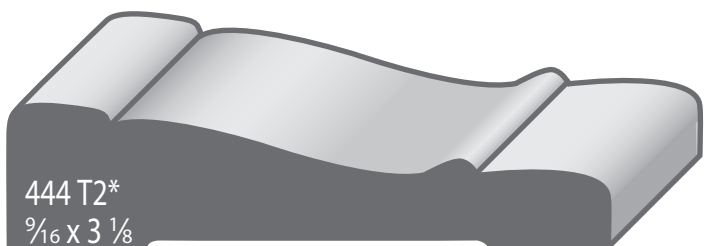
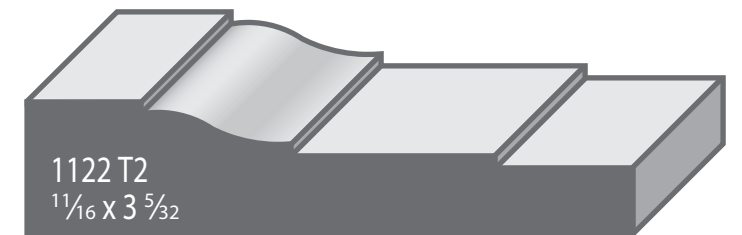
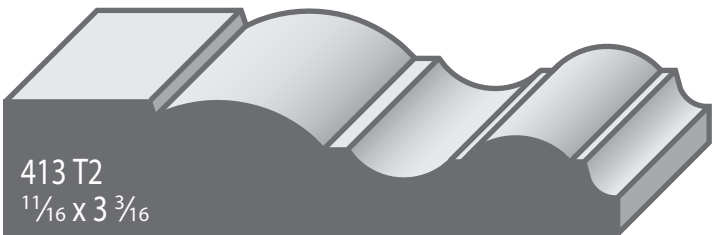
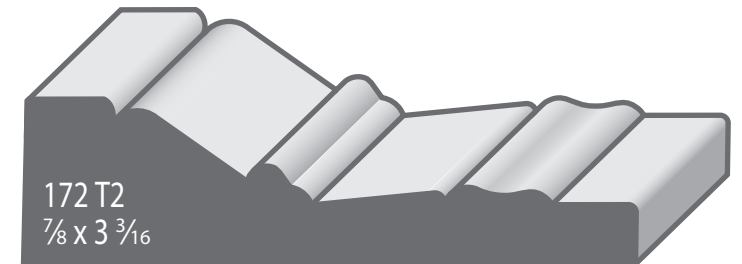
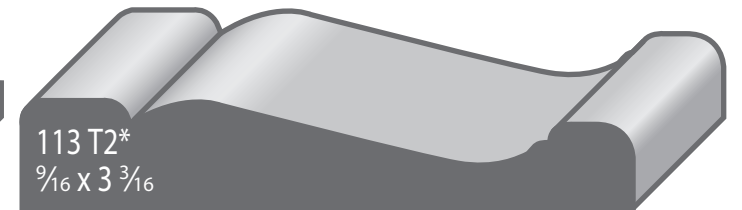
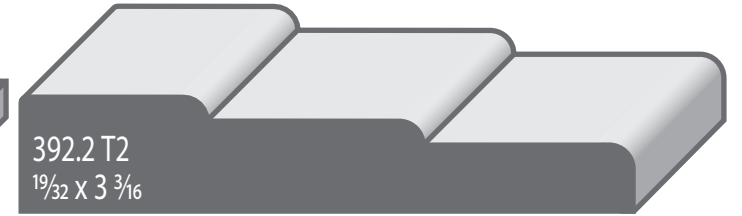
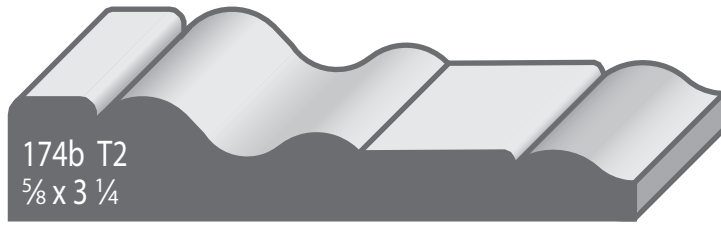
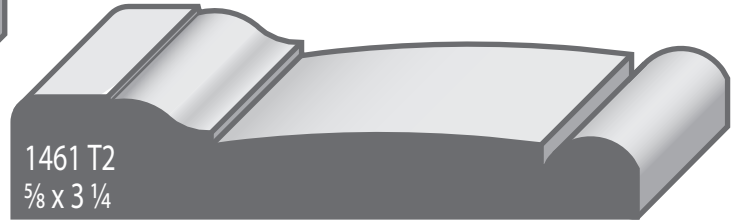
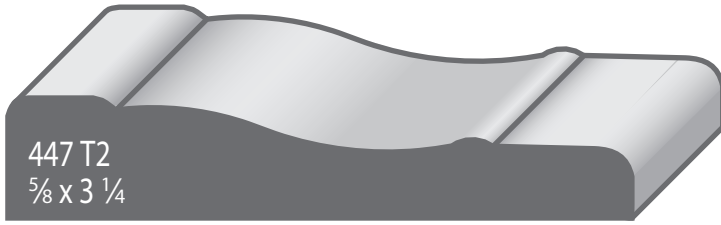

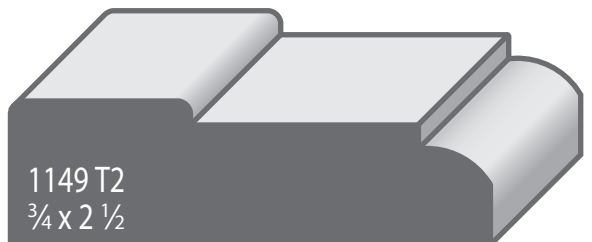
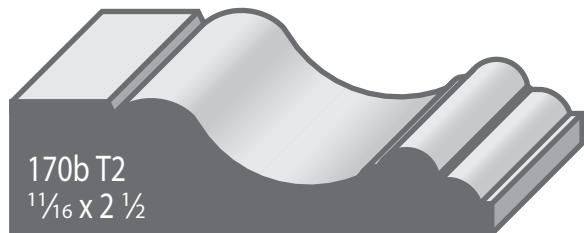
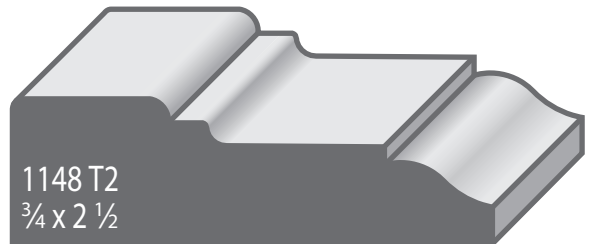
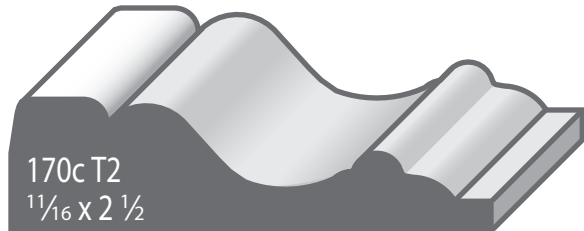
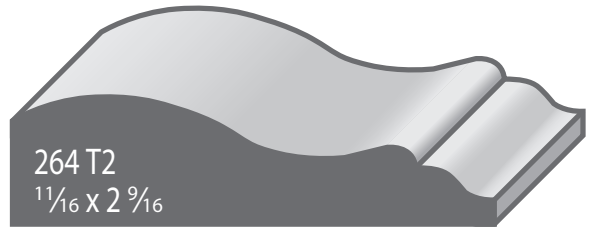
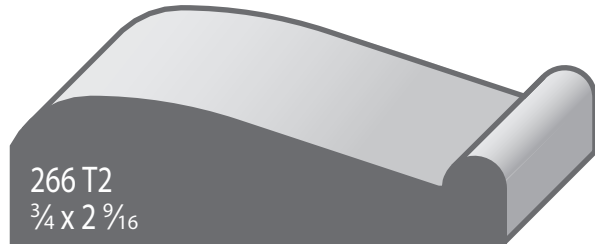
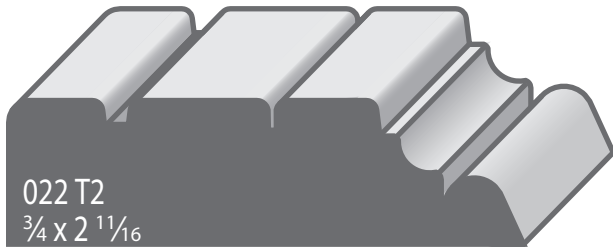
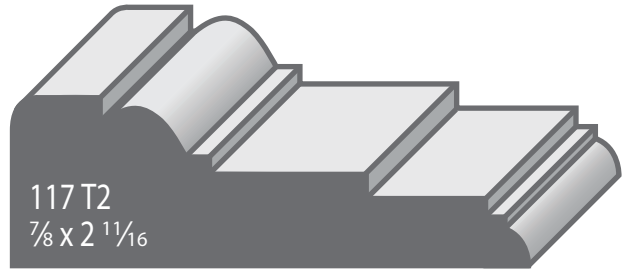
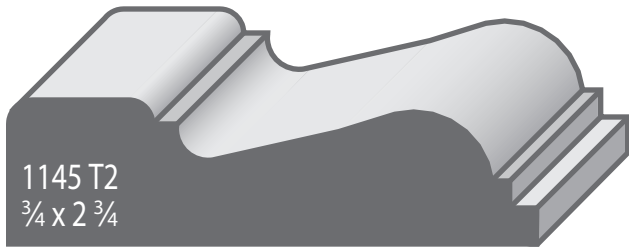
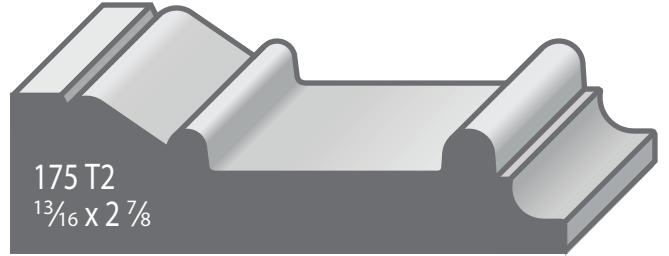
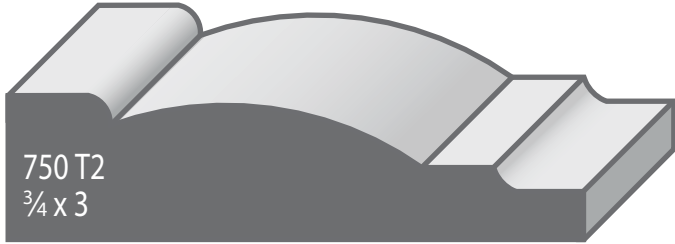
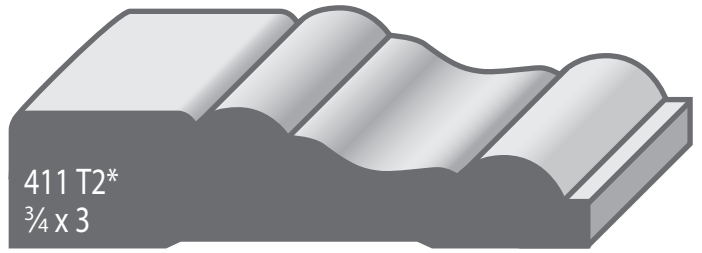

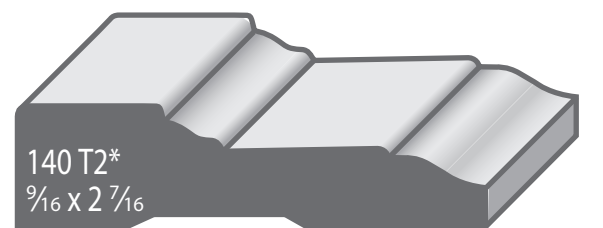
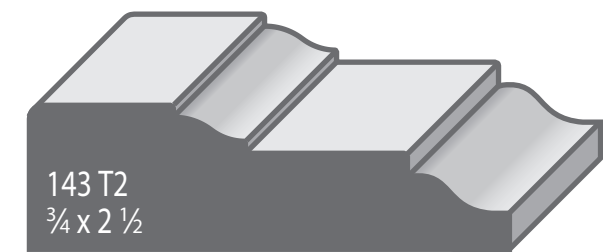
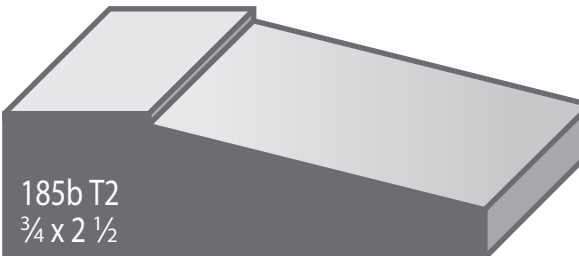
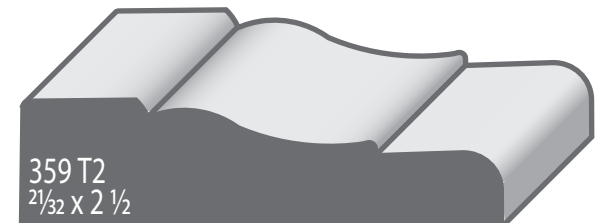
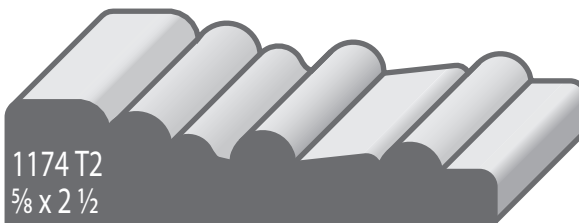
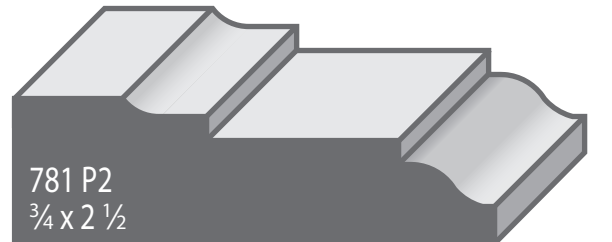
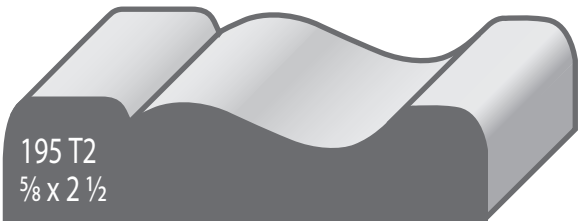
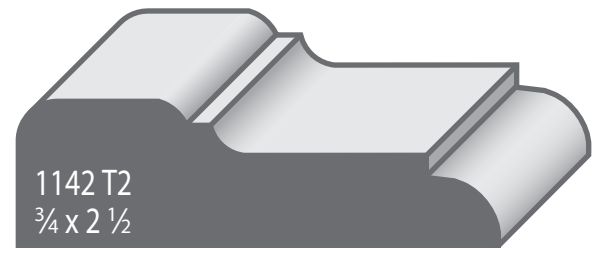
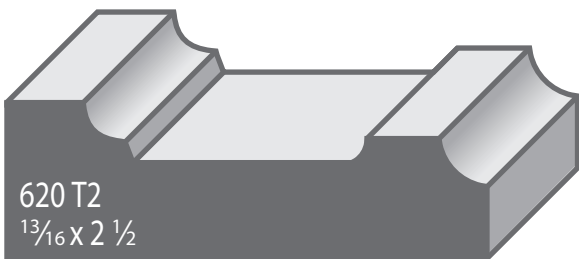
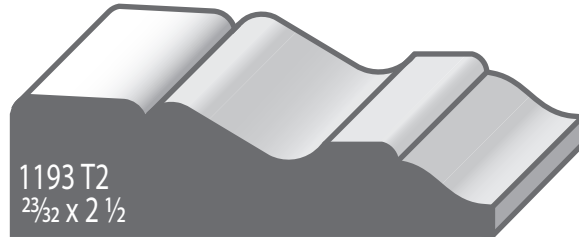
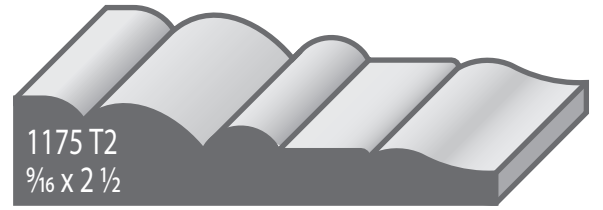
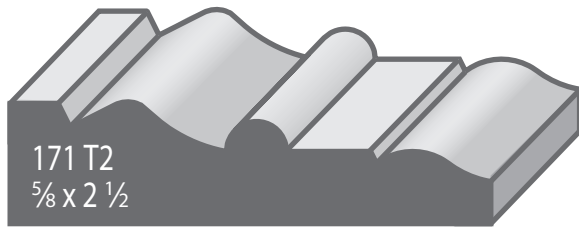

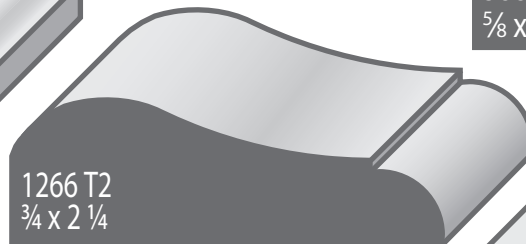
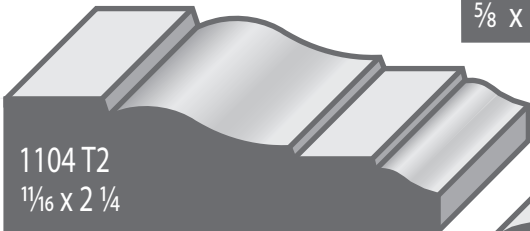
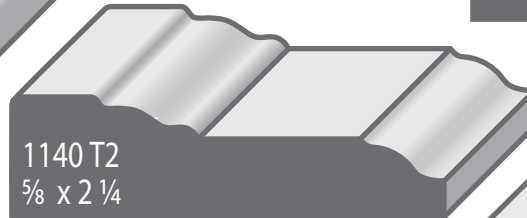
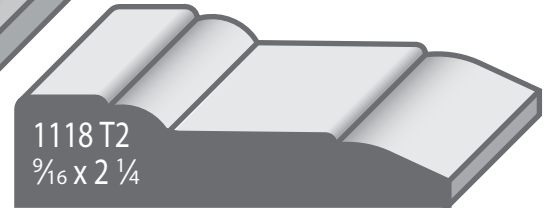
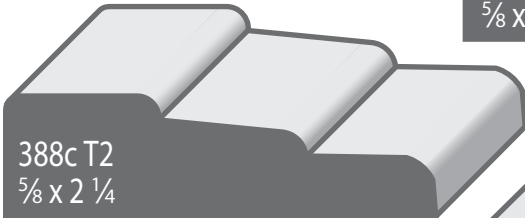
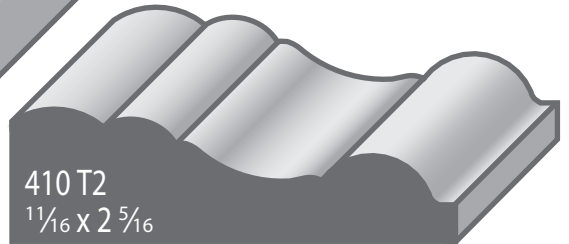
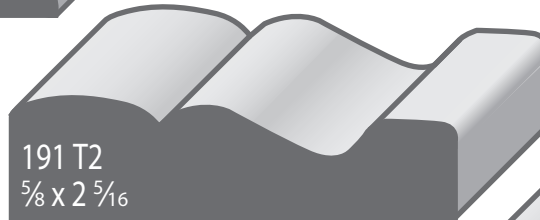
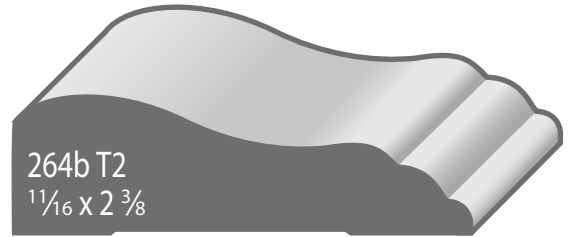
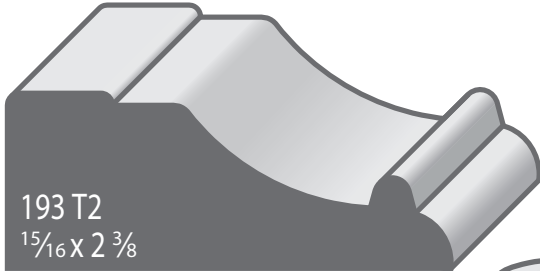
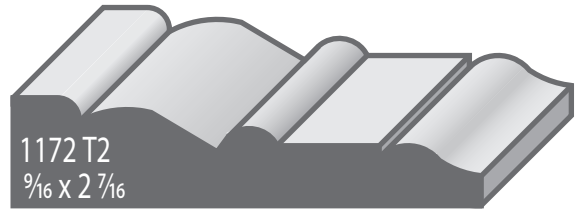

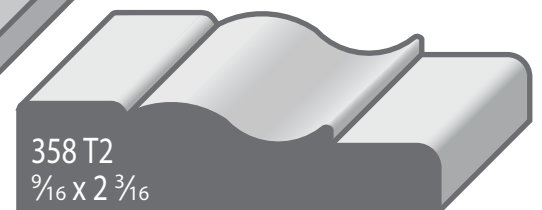
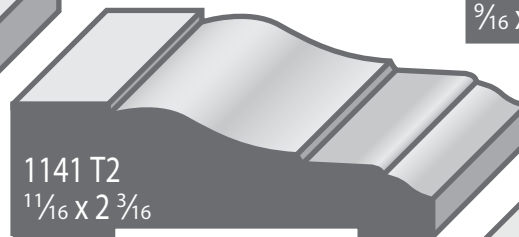
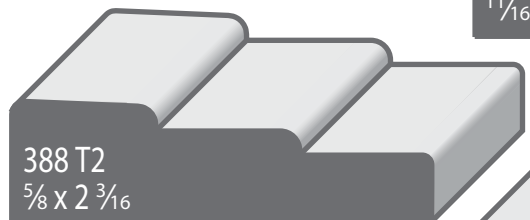
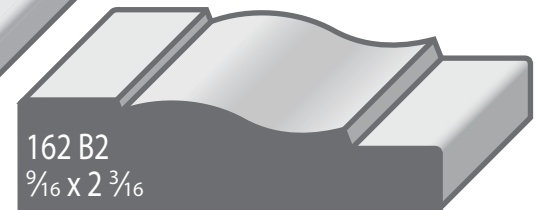
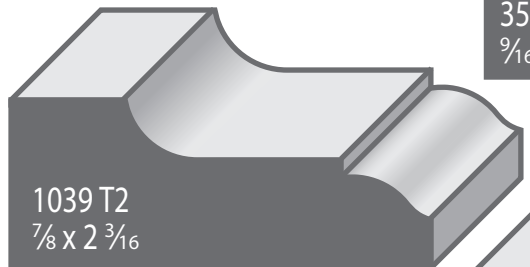
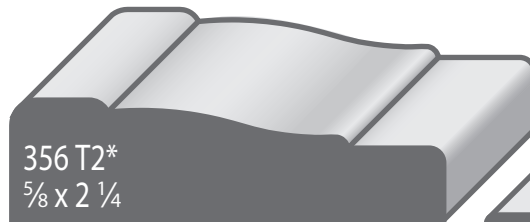
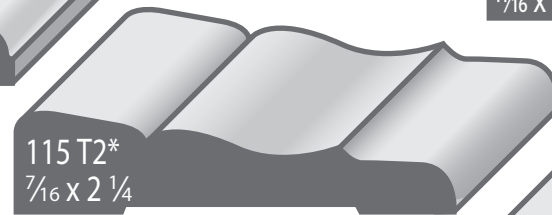
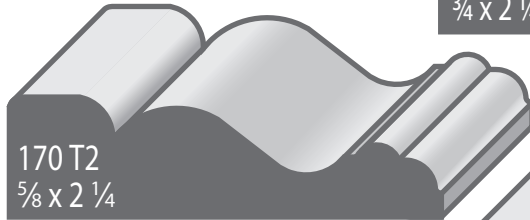
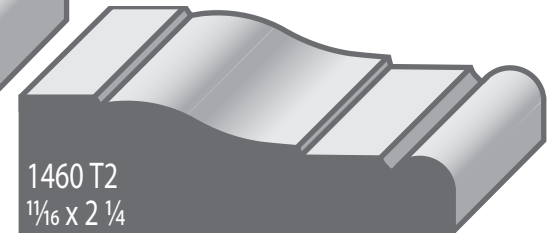
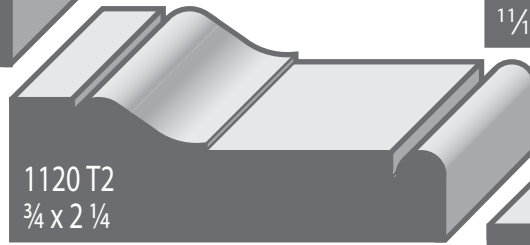
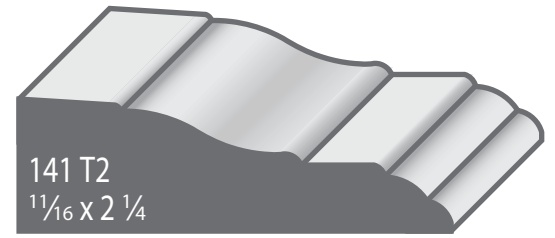
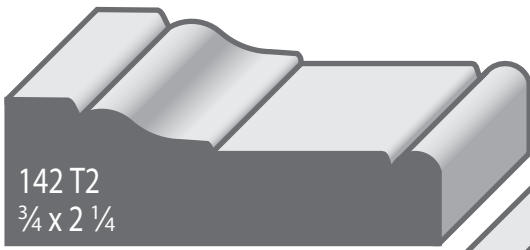

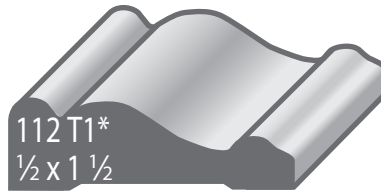
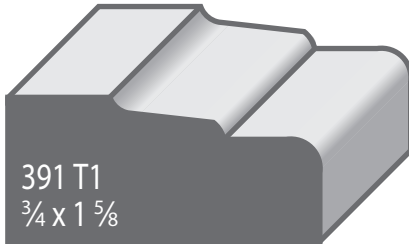

Pair with Plinth
#1037 T2 and
Base 331 BV

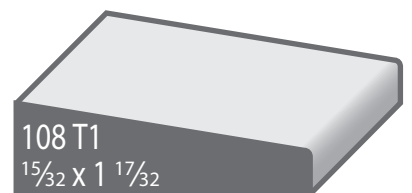
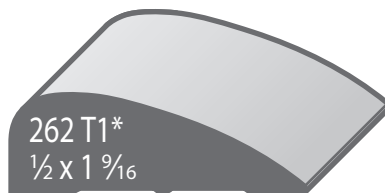
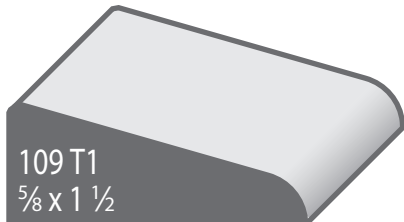
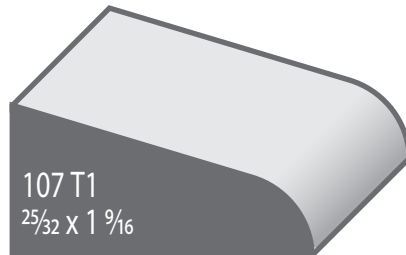
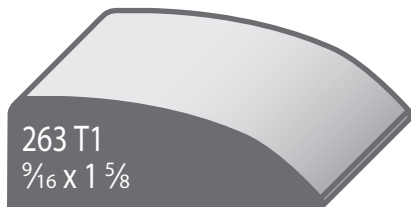
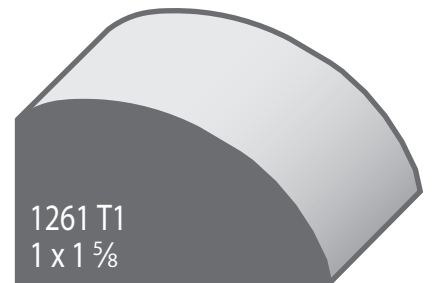
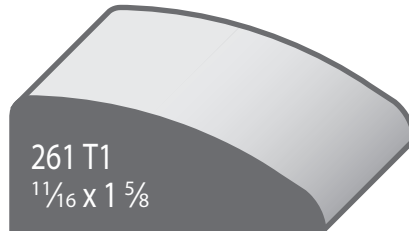
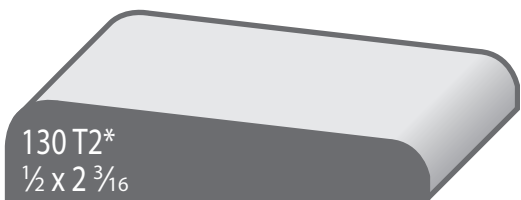
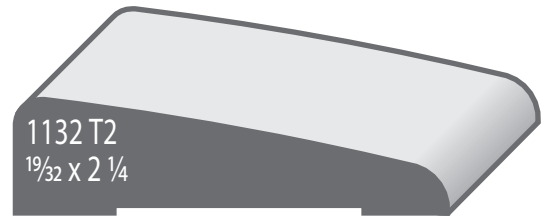
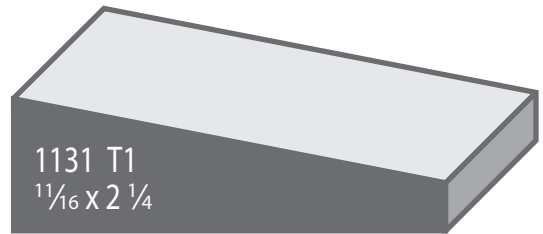
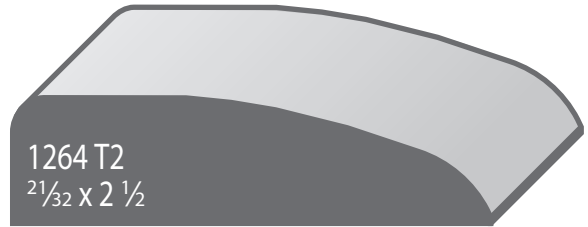
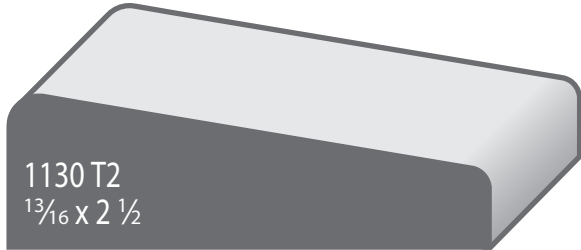
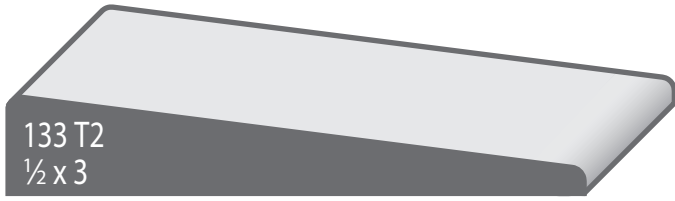

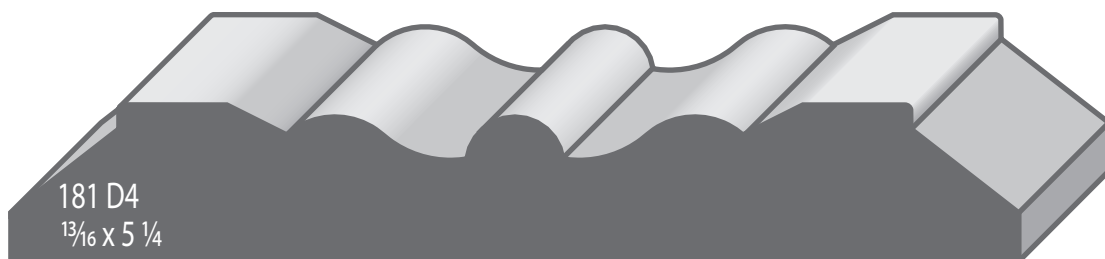
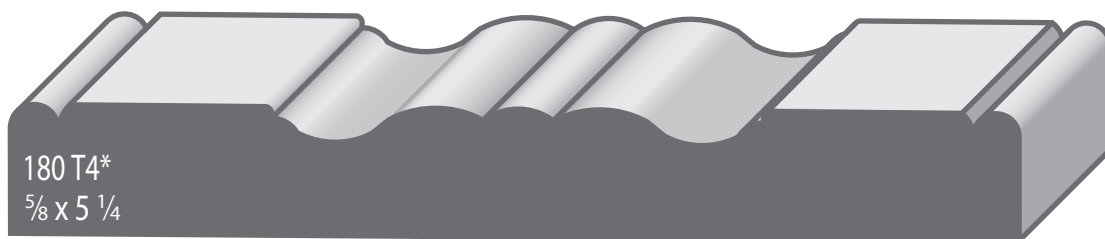
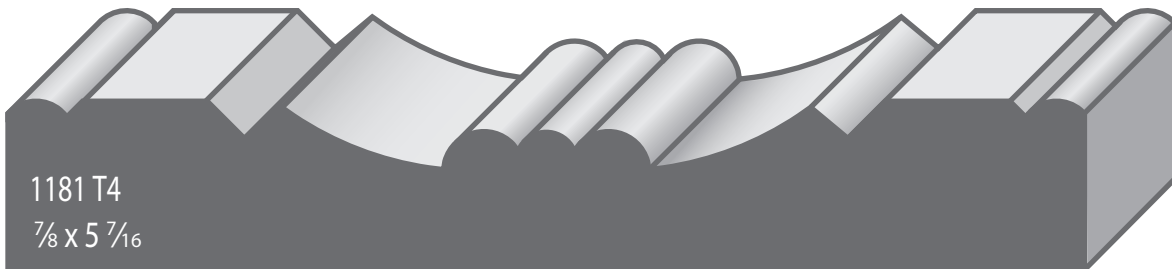
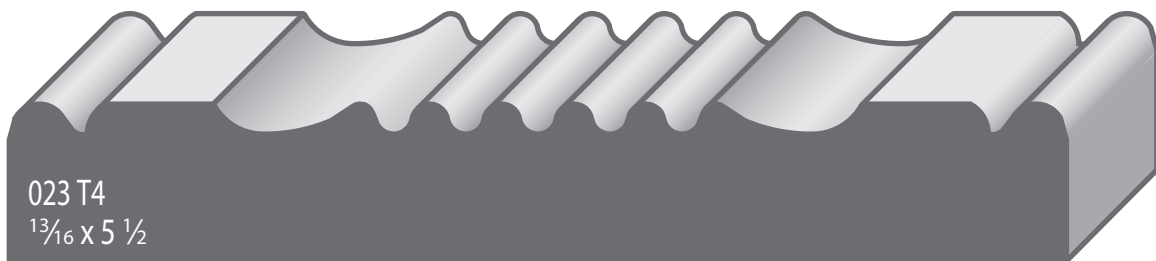

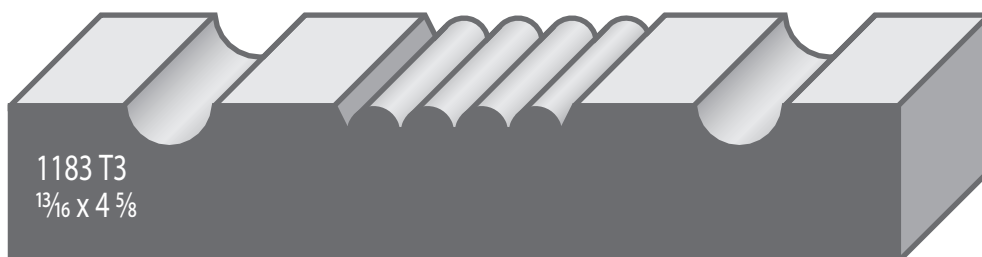
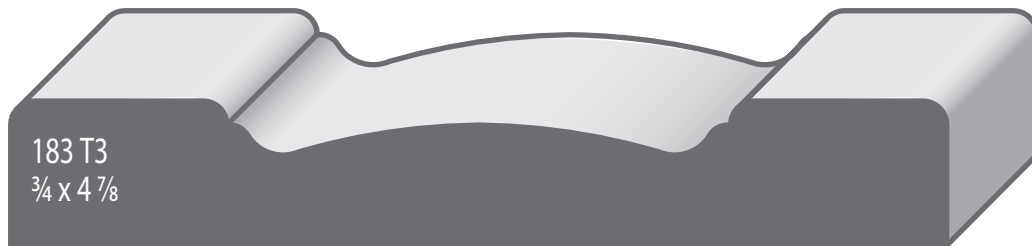
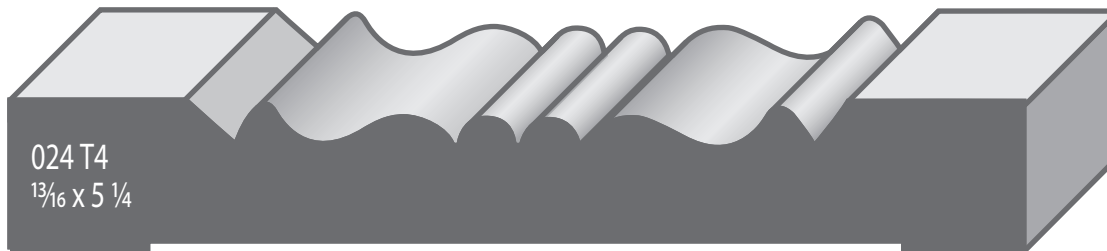
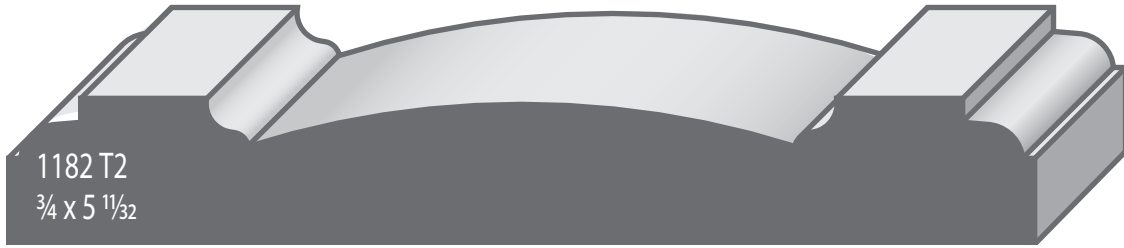



SYMMETRICAL CASING

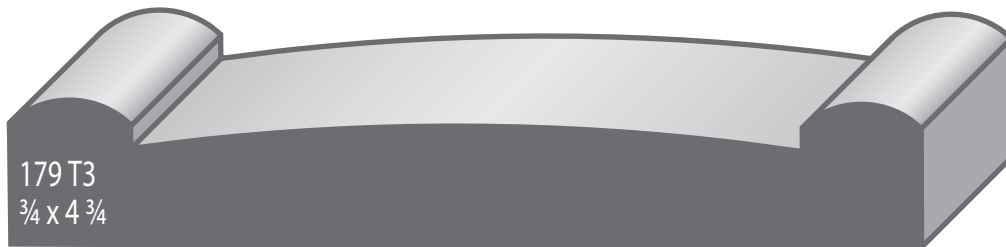
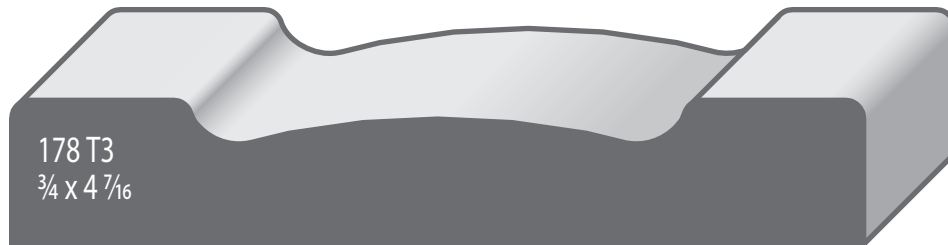
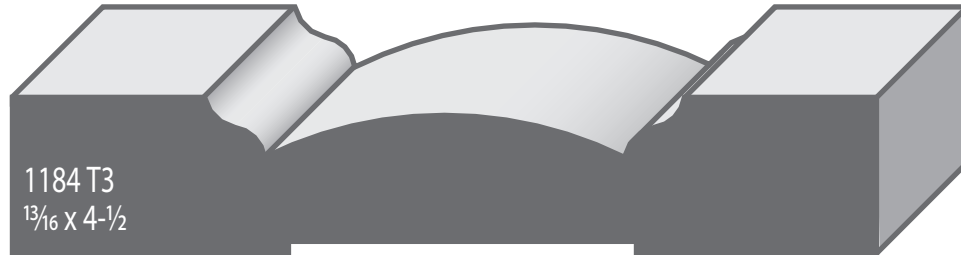

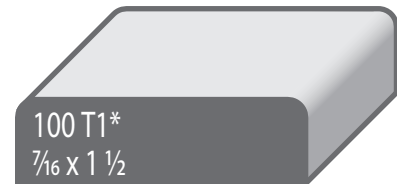
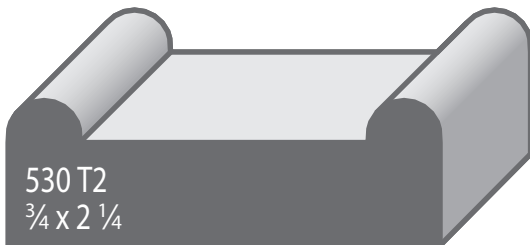
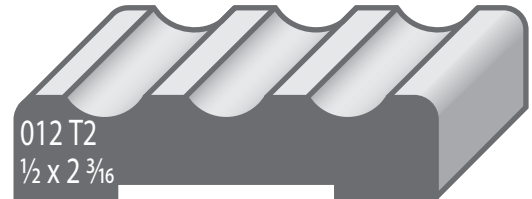
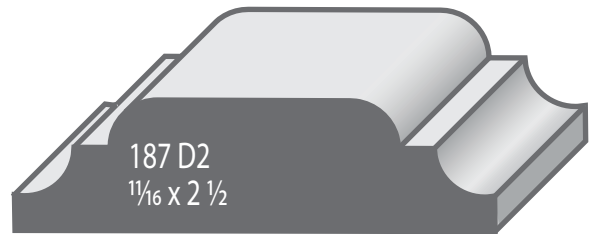

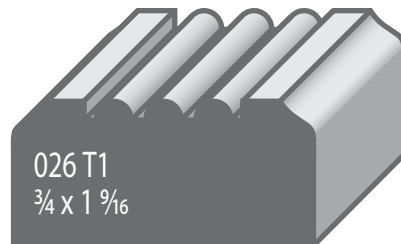
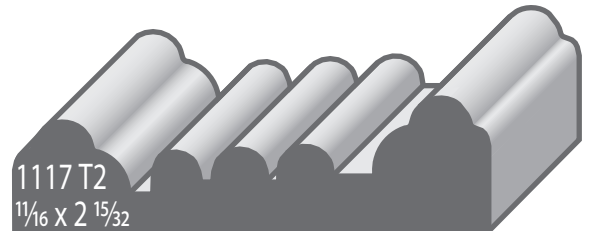
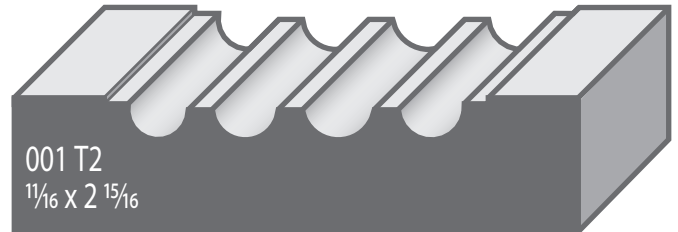
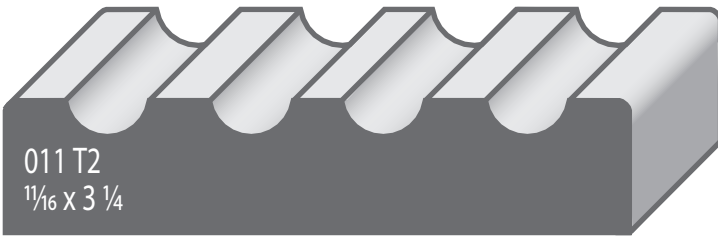
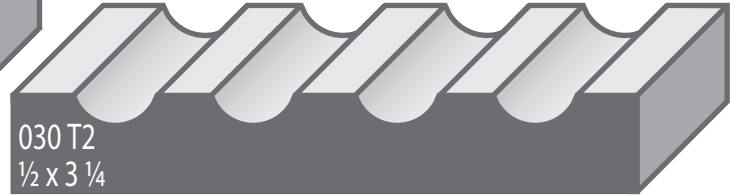
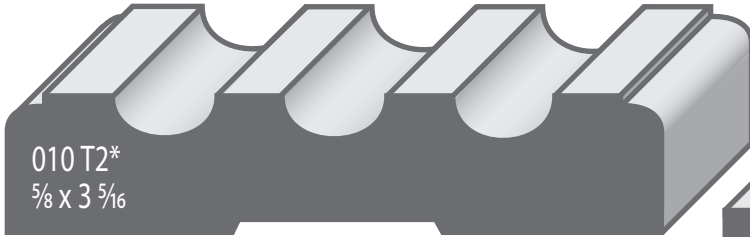
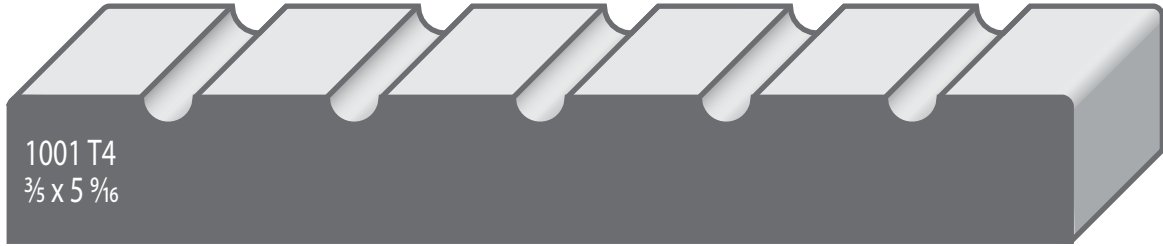

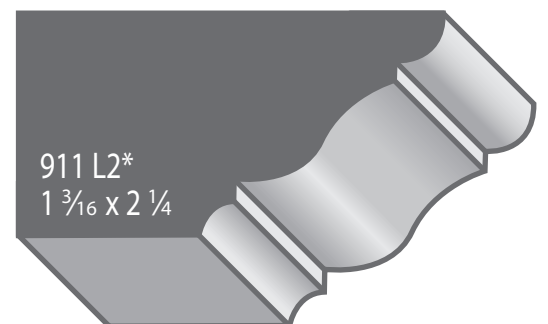
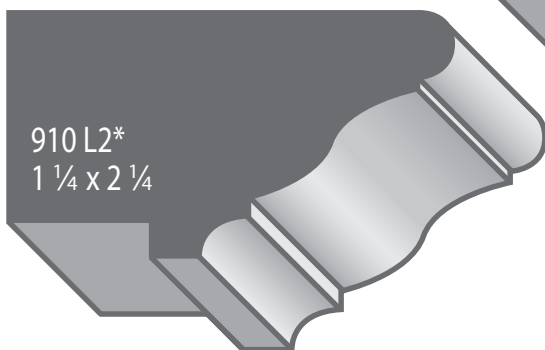
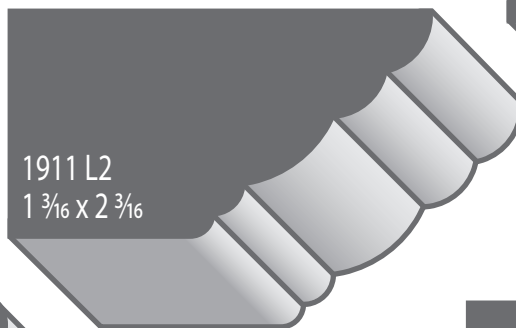
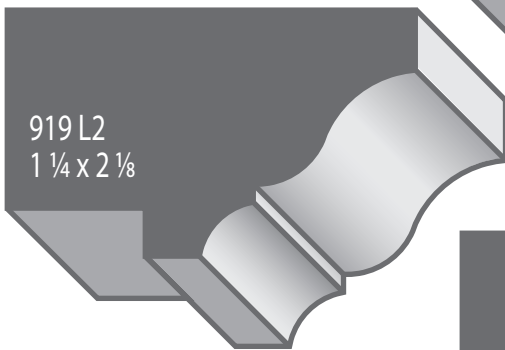
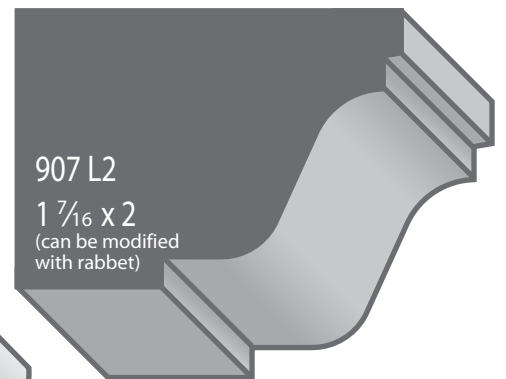
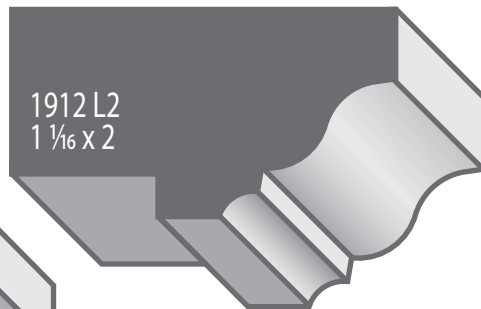
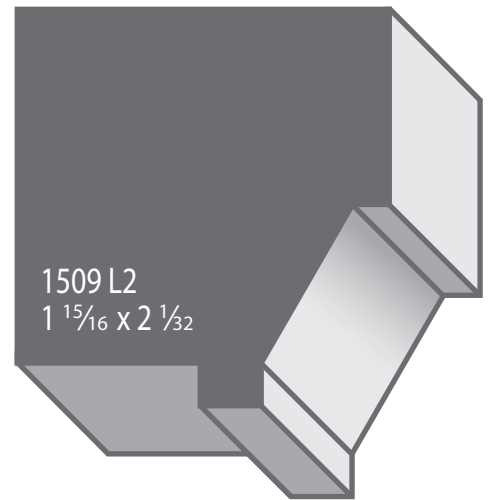
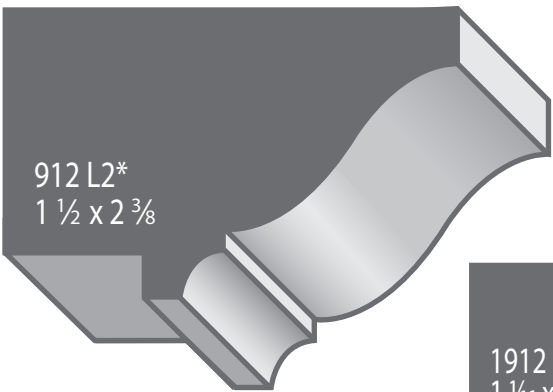
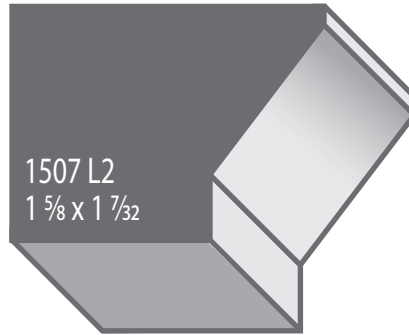
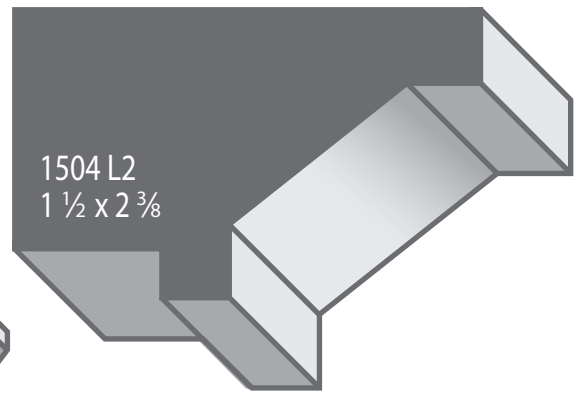
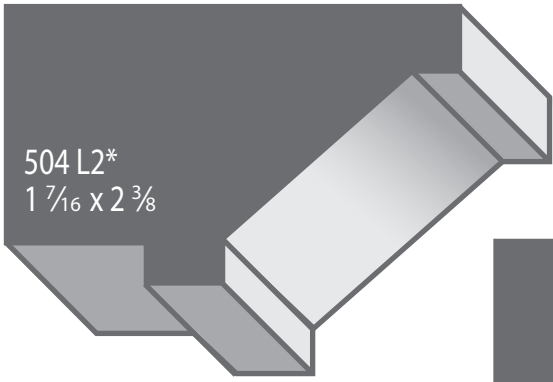

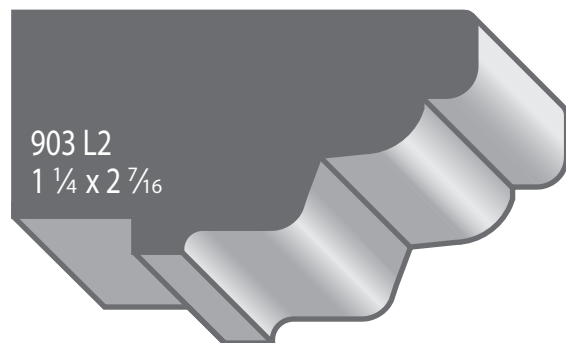
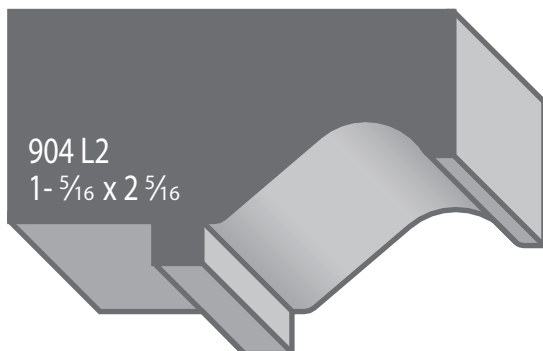
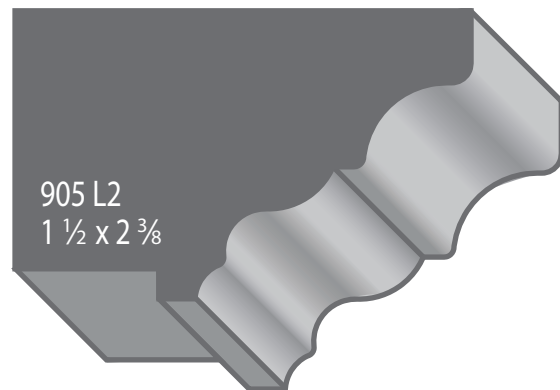
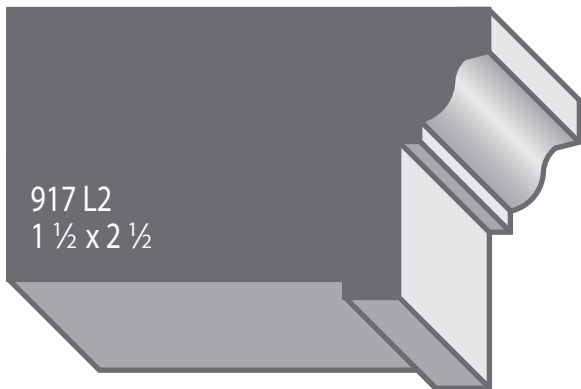
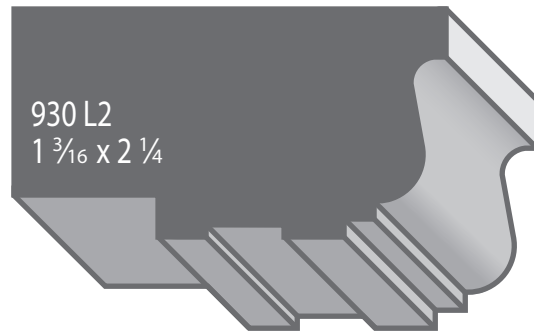
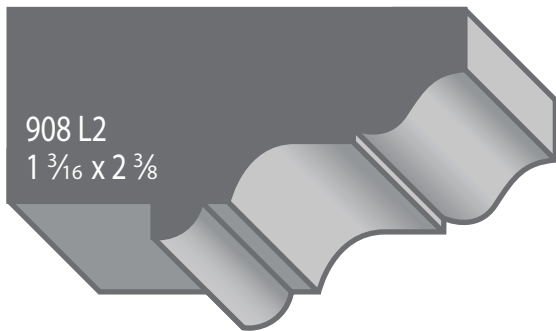
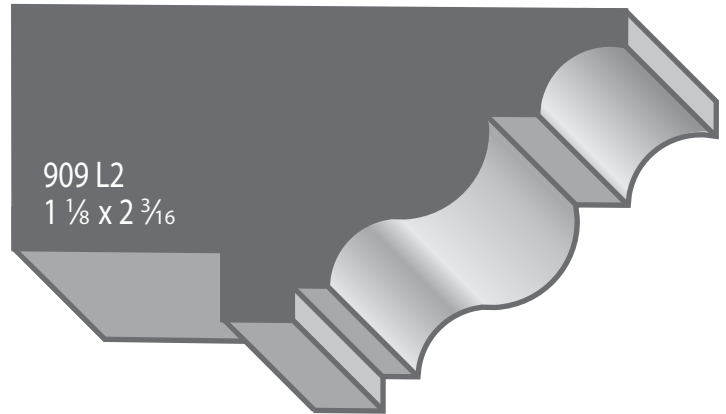
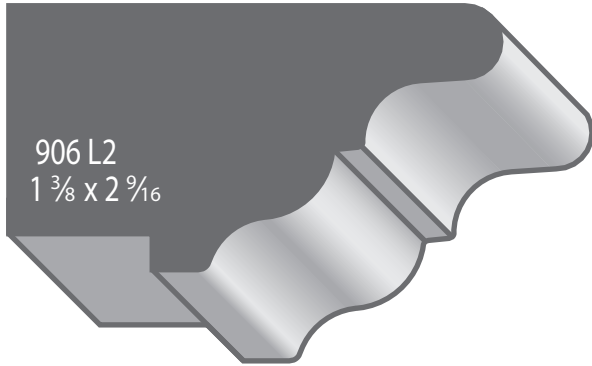
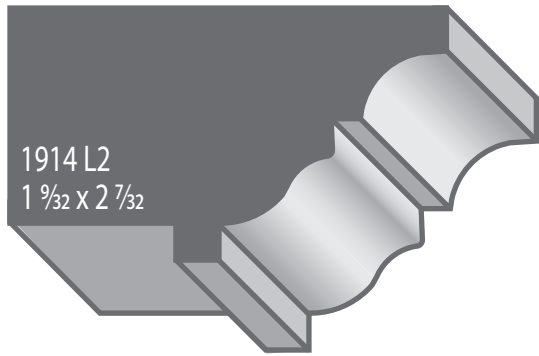

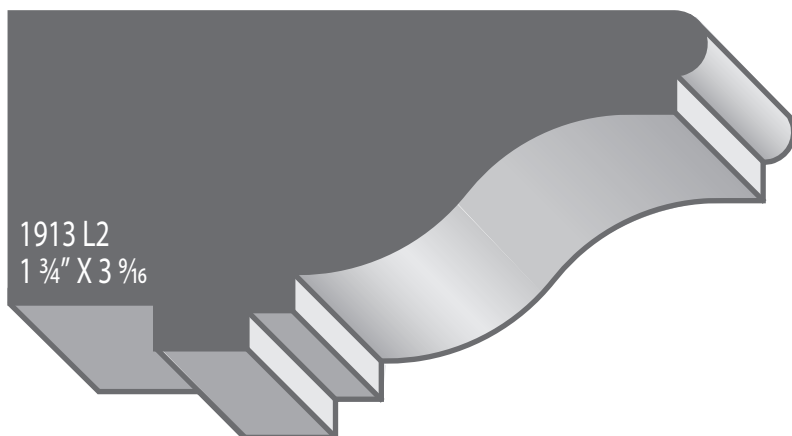
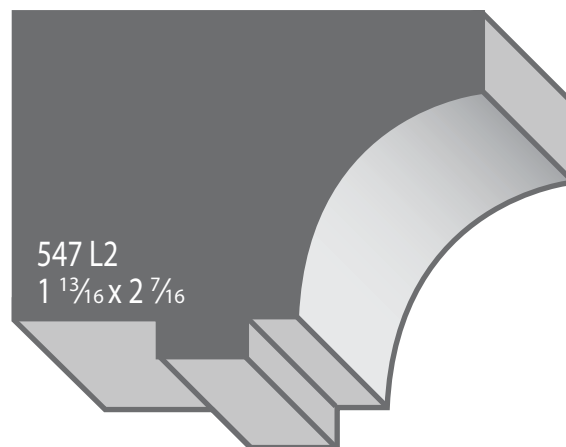
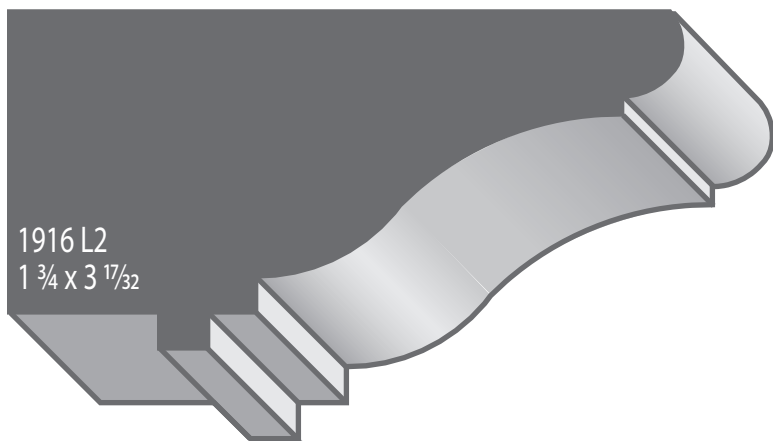
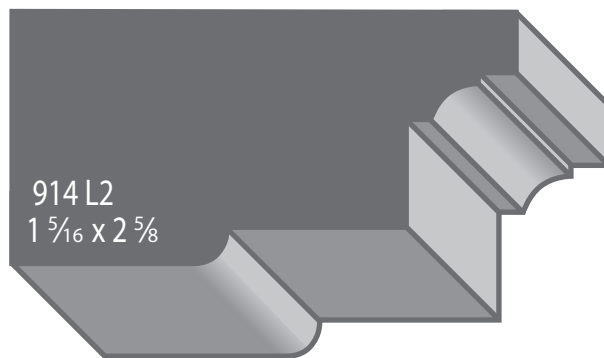
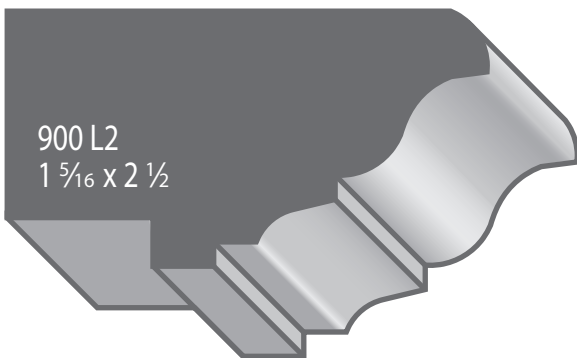
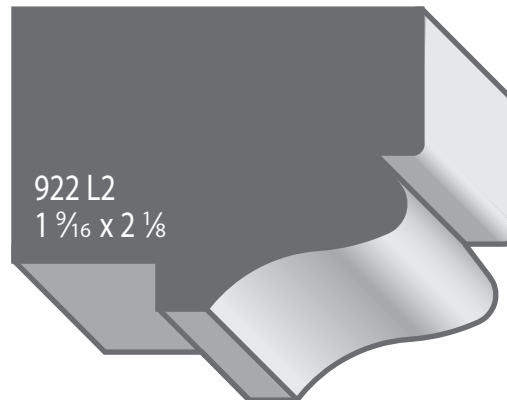
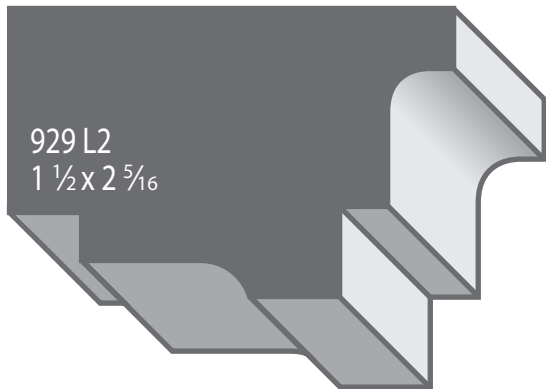

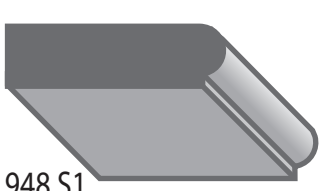
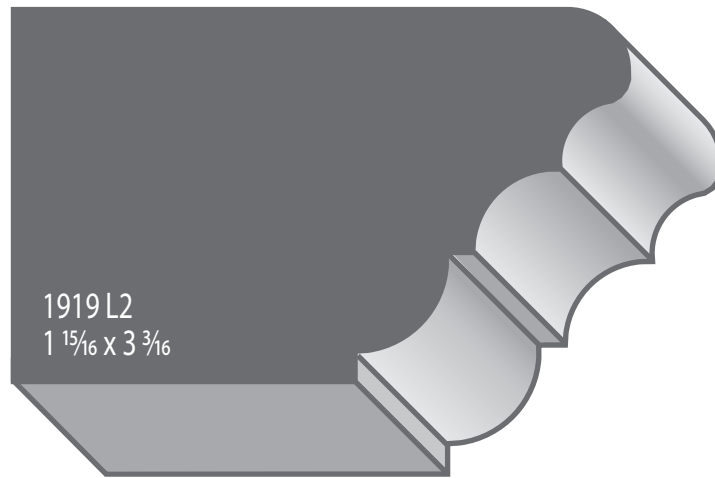
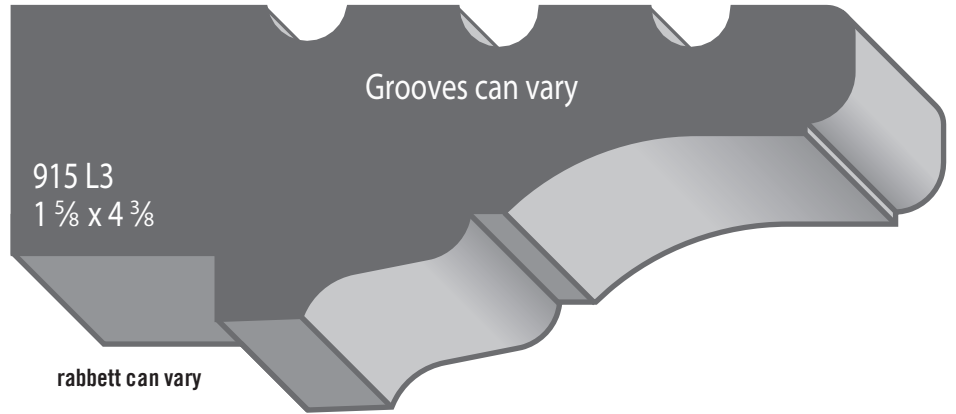
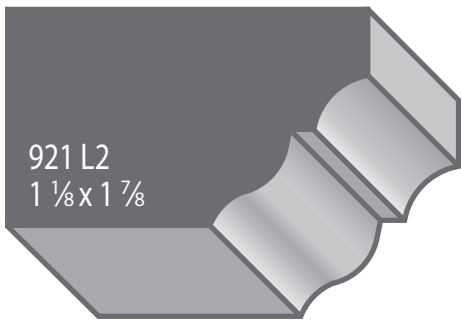

948 S1
5/16 x 1 1/8

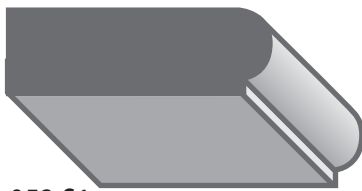

953 S1
3/8 x 1 5/8



949 S1
1/2 x 1 5/8

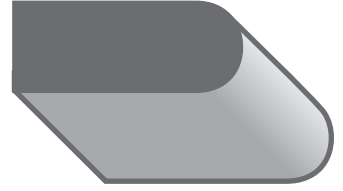

950 S1*
7/16 x 1 1/4



503 S1*
1/2 x 1 1/8



955 S1*
1/2 x 1 1/4



954 M1
1 1/16 x 1 1/2

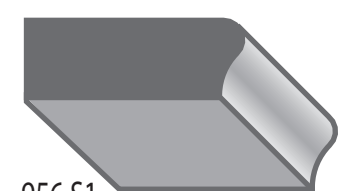

956 S1
3/8 x 1 1/8

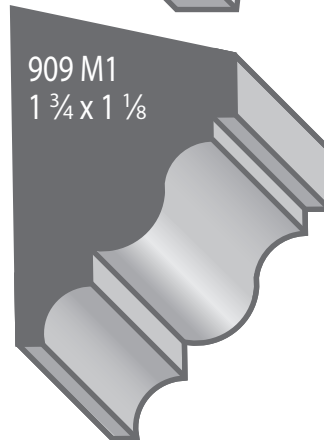
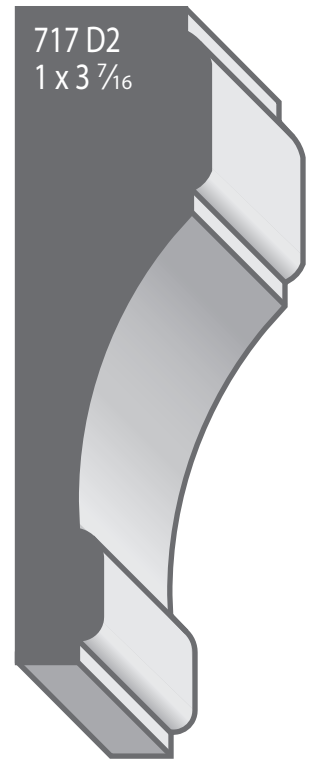
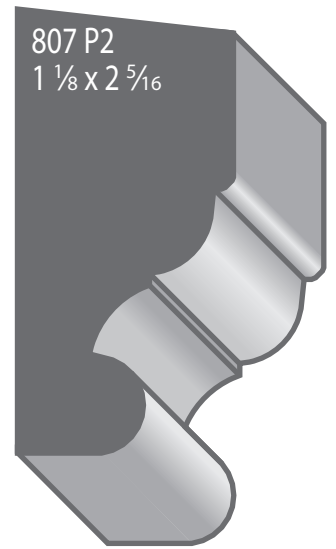

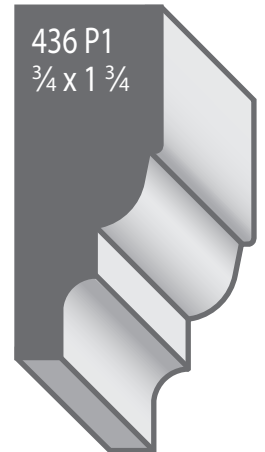
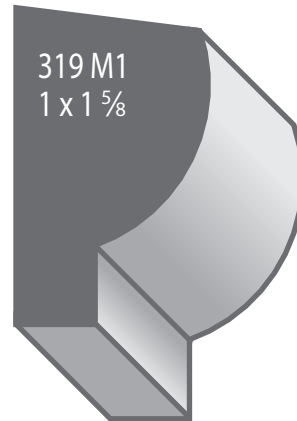
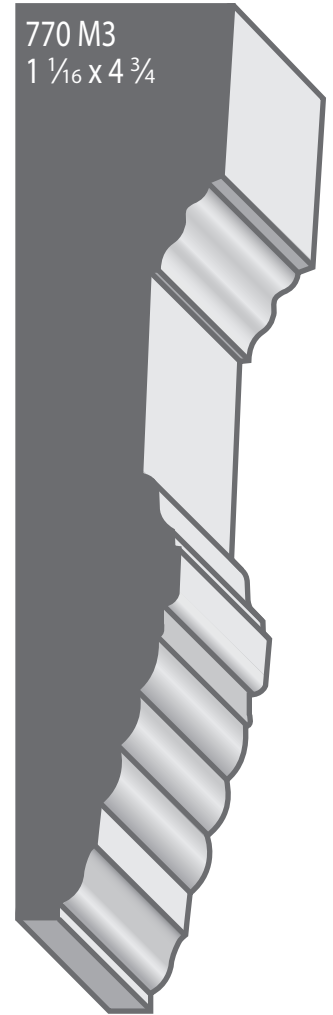
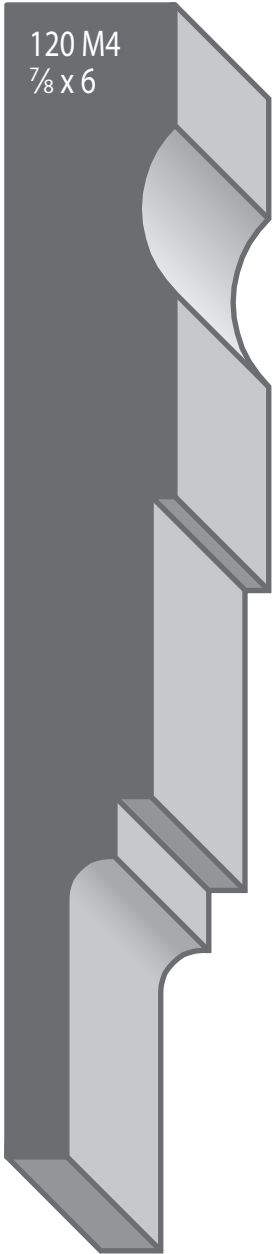



Architrave
753 D4
1 ¹³/₁₆ X 7 ⁵/₁₆

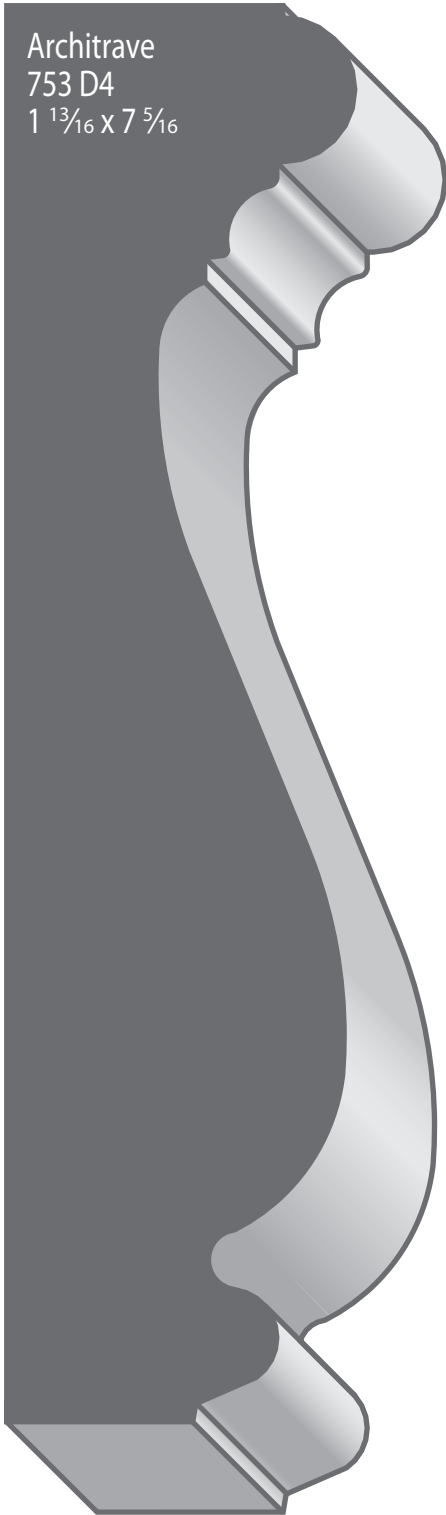



888 MV*
1 x 3 ³/₈ - 7 ³/₈ (Variable)



887 MV
1 ⁷/₁₆ x 3 (Variable)



889 MV
1 x 3 ³/₈ - 7 ³/₈ (Variable)

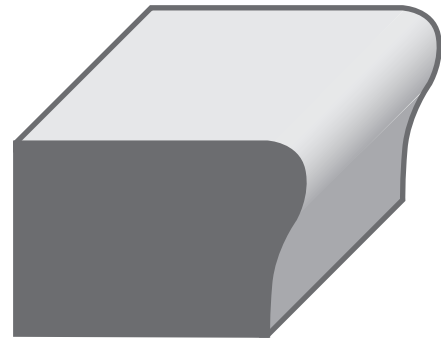

886 MV
1 x 1 ¹/₂ (Variable)

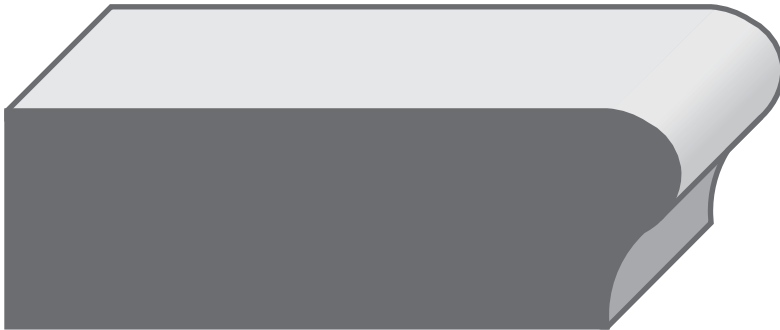

885 MV
1 ¹/₈ x 3 ¹/₂ - 7 ³/₈ (Variable)



422 S1
 $\frac{3}{4} \times 1\frac{11}{16}$

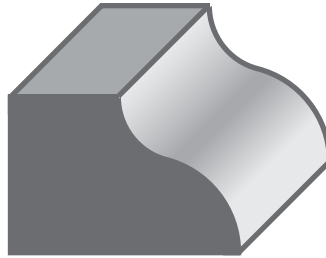

423 S1
 $1\frac{3}{16} \times 1\frac{3}{16}$

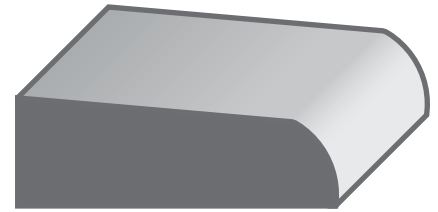

409 S1
 $\frac{9}{16} \times 1\frac{11}{16}$



415 S1
 $\frac{1}{2} \times 1\frac{1}{2}$

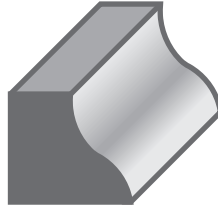

419 S1
 $\frac{9}{16} \times \frac{5}{8}$

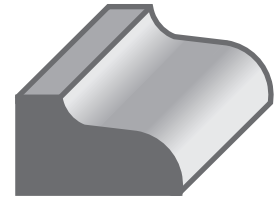

424 S1
 $\frac{1}{2} \times \frac{7}{8}$



420 S1*
 $\frac{3}{8} \times 1\frac{9}{16}$

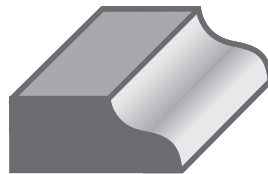

417 S1*
 $\frac{3}{8} \times \frac{7}{8}$

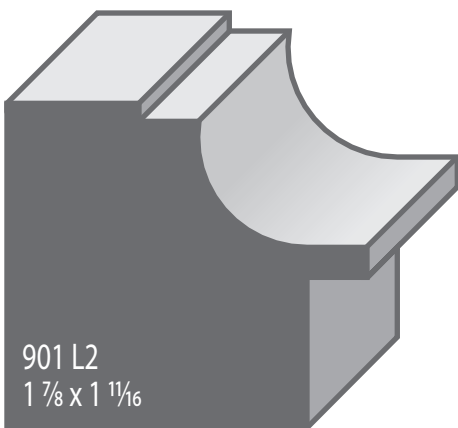

901 L2
 $1\frac{7}{8} \times 1\frac{11}{16}$

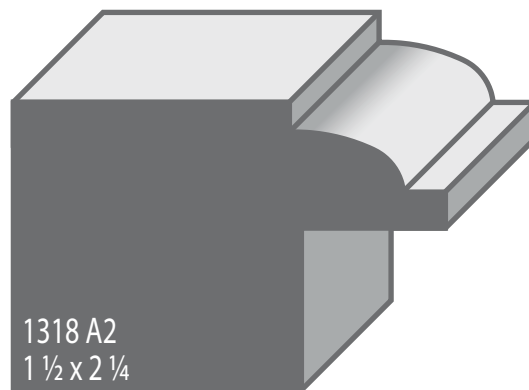

1318 A2
 $1\frac{1}{2} \times 2\frac{1}{4}$

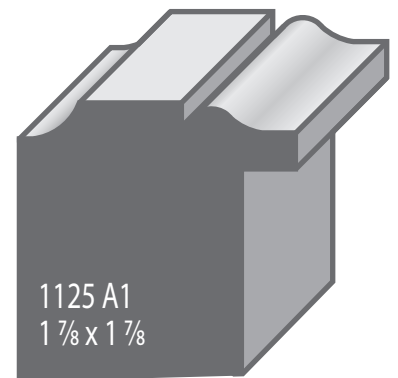

1125 A1
 $1\frac{7}{8} \times 1\frac{7}{8}$

