

Section B - Casings

McCOY MILLWORK

Custom Shop Services

For custom profiles pricing is determined by the chosen species of wood and quantity. Provide the following:

1. A sample or scale drawing of the profile.
2. Amount of moulding needed in Lineal Feet.
3. Preferred species of wood.
4. Preferred final finish (paint or stain).

Send us your information via email or come in for a quote. You can expect to hear from us regarding pricing in 2 days.

Manufacturing time varies: 2 days-2 weeks.

Profile #	Pg #	Profile #	Pg #	Profile #	Pg #	Profile #	Pg #
001-T2 Fluted Casing	69	121-T2 Casing	56	171B-T2 Casing	41	268B-T2 Clamshell Casing	62
010-T2* Fluted Casing	69	122-T2 Casing	58	171-T2 Casing	41	268 T2 Clamshell Casing	62
011-T2 Fluted Casing	69	130-T2* Casing	61	172-T2 Casing	56	269 M2 Apron	74
012-T2 Fluted Casing	69	131-T2* Sanitary Casing	61	173B-T2 Casing	40	304 A2 Backband	79
013-T2 Fluted Casing	69	133-T2 Casing	61	173-T2 Casing	40	319 M1 Apron	75
014-T2 Fluted Casing	69	134-T2* Casing	55	174B-T2 Casing	55	355 T2 Casing	46
015-T2 Fluted Casing	69	137-T2 Casing	60	174-T2 Casing	40	356 T2* Casing	46
021-T2 Reeded Casing	68	138-T4 Casing	49	175-T2 Casing	57	357 T2 Casing	46
022-T2 Casing	57	139-T2 Casing	58	176-T2 Casing	54	358B-T2 Col Casing	46
023-T4 Sym Casing	63	140-T2* Casing	43	177B-T3 Casing	50	358 T2 Casing	46
024-T4 Sym Casing	64	141-T2 Casing	43, 59	177-T3 Casing	51	359 T2 Casing	46
025-T2 Reeded Casing	68	142-T2 Casing	59	178-T2 Casing	67	384 BV Apron	74
026-T1 Reeded Casing	68	143-T2 Casing	43	178-T3 Symm Casing	66	386 T3 Casing	50
027-T2 Reeded Casing	68	144-T2 Casing	60	179-T3 Sym Casing	65	387 MV Casing	56
028-T2 Sym Casing	68	145-T3 Casing	55	180-T4* Sym Casing	64	387 T2 Casing	55
029-T2 Symmetrical Casing	67	148-T2 Casing	53	181B-T4 Casing	63	388b T2 Casing	59
030-T2 Fluted Casing	69	149B-T2 Casing	56	181-D4 Sym Casing	64	388c T2 Casing	59
031-T3 Symm Casing	66	149-T2 Casing	54	181-T4 Sym Casing	64	388d T2 Casing	59
100-T1* Sym Casing	68	150B-T2 Casing	42	183-T3 Sym Casing	65	388 T2 Casing	60
107-T1 Casing	61	150C-T2 Casing	42	185B-T2 Sym Casing	58	390 T2 Casing	54
108-T1 Casing	61	150-T2* Casing	43	185-T2* Casing	55	391 T1 Casing	60
109-T1 Casing	61	151-T3 Casing	49	187-D2 Symm Casing	67	392.2 T2 Step Casing	56
110-T1* Casing	61	152-T3 Casing	49	191-T2 Casing	59	392 T2 Step Casing	56
111B-T2 Casing	40	153-M2 Apron	74	193-T2 Casing	59	409 S1 Stop	78
111C-T2 Casing	41	153-T3 Casing	48	194-T2 Casing	59	410 T2 Casing	59
111-T2* Casing	41	155-T3* Casing	51	196-T2 Casing	58	411 T2* Casing	57
112-T1* Casing	60	156-T2 Casing	42	207-T3 Apron/Casing	75	413 T2 Casing	56
113B-T3 Casing	52	158B-T3 Casing	51	245-T2 Casing	57	415 S1 Stop	78
113-T2* Casing	56	158-T2 Casing	53	248-P2 Casing	60	416 T3 Casing	49
114-BV Casing	47	158-T3 Casing	48	261-T1 Clamshell Casing	62	417 S1* Stop	78
115-T2* Casing	46	158-T4 Casing	47	262 T1* Clamshell Casing	62	419 S1 Stop	78
116-T2 Casing	54	159B-T3 Casing	42	263 T1 Clamshell Casing	62	420 S1* Stop	78
117-T2 Casing	57	159-T3 Casing	42	263 T2 Clamshell Casing	62	421-S1 Stop	78
118-T2 Casing	57	162-B2 Casing	46	264b T2 Casing	59	422 S1 Stop	78
119-T3 Casing	51	170B-T2 Casing	45	264 T2 Casing	57	423 S1 Stop	78
120-M4 Apron	75	170C-T2 Casing	45	265 T2* Clamshell Casing	62	424 P2 Misc/Apron	74
120-T2 Casing	56	170-T2 Casing	45	266 T2 Casing	57	424 S1 Stop	78



Profile #	Pg #	Profile #	Pg #	Profile #	Pg #	Profile #	Pg #
427 P2	Apron 74	889 MV	Sill 78	1029 A1*	Backband 80	1159 T2	Casing 54
436 P1	Apron 74	894 D2	Sym Casing 67	1039 T2	Casing 60	1170B-T2	Casing 41
444 T2*	Casing 46	899 L2	Lintel 72	1104 T2	Casing 59	1170 T2	Casing 41
447 T2	Casing 46	900 L2	Lintel 73	1105 T2	Casing 60	1171 T2	Casing 40
448 T2	Casing 46	901 L2	Backband 79	1111B-T2	Casing 40	1172 T2	Casing 41
487 T2	Casing 57	902 L2	Lintel 71	1111-T2	Casing 40	1173B-T2	Casing 40
488 T2	Casing 55	903 L2	Lintel 71	1113-T2	Casing 55	1173 T2	Casing 41
496 T3	Casing 49	904 L2	Lintel 71	1114 T3	Casing 52	1174 T2	Casing 58
503 S1*	Parting Bead 73	905 L2	Lintel 71	1117 T2	Reeded Casing 68	1175 T2	Casing 41
504 L2*	Lintel 70	906 L2	Lintel 71	1118 T2	Casing 43	1176 T2	Casing 40
525-T4	Symm Casing 64	907 L2	Lintel 70	1120 T2	Casing 59	1177 T2	Casing 40
528 PV	Apron 74	908 L2	Lintel 71	1121 T2	Casing 55	1181 T4	Sym Casing 63
529 T2	Sym Casing 67	909 L2	Lintel 71	1122 T2	Casing 56	1182 T4	Sym Casing 64
530 T2	Symm Casing 68	909 M1	Apron 76	1123 A1	Backband 80	1183B-T4	Sym Casing 63
533B-T2	Casing 43	910 L2*	Lintel 70	1123-T2	Casing 57	1183 T3	Sym Casing 65
533 T2	Casing 43	911 L2*	Lintel. 70	1124 T2	Casing 55	1183 T4	Sym Casing 65
534 T2	Casing 56	912 L2*	Lintel 70	1125 A1	Backband 79	1184 T3	Sym Casing 66
534-T3	Casing 50	913 L2	Lintel 73	1126 A1	Backband 79	1188 T4	Sym Casing 63
535 T2*	Casing 54	914 L2	Lintel 72	1127 A1	Backband 80	1193 T2	Casing 58
536 T3	Casing 50	915 L3	Lintel 73	1128 A1	Backband 80	1203 T2	Casing 60
547 L2	Lintel 72	916 L2	Lintel 72	1129 A1	Backband 80	1211 T4	Casing 47
620 T2	Casing 58	917 L2	Lintel 71	1130 T2	Casing 61	1212 T4	Casing 47
717 D2	Apron 75	919 L2	Lintel 70	1131 T1	Casing 61	1213 T3	Casing 50
726 P2	Apron 74	921 L2	Lintel 72	1132 T2	Sanitary Casing 61	1214 T4	Casing 47
746 P2	Apron 75	922 L2	Lintel 72	1133 T2	San Casing 61	1261 T1	Clamshell Casing 62
750 T2	Casing 57	929 L2	Lintel 72	1136-A1	Backband 79	1262 T1	Clamshell Casing 62
751 MV	Apron 74	930 L2	Lintel 71	1137 T4	Casing 42	1264 T2	Clamshell Casing 62
753 D4	Architrave 77	931 M2	Apron 74	1138 T3	Casing 49	1266 T2	Casing 59
755 T2	Casing 57	948 S1	Bead 73	1139B-TV	Casing 53	1270-T2	Casing 45
756 T2	Casing 52	949 S1	Bead 73	1139 T2	Casing 53	1316 T3	Casing 50
757 T4	Casing 47	950 S1*	Parting Bead 73	1139 T3	Casing 48	1318 A2	Backband 79
758-T3	Casing 49	953 S1	Bead 73	1140 T2	Casing 43	1318B-A2-1	Backband 79
770 M3	Apron 75	954 M1	Bead 73	1141 T2	Casing 60	1318B-A2	Backband 79
772 M4	Apron 75	955 S1*	Parting Bead 73	1142 T2	Casing 58	1319 M1	Apron 75
781 P2	Casing 58	956 S1	Parting Bead 73	1143 T2	Casing 58	1381 T3	Casing 51
782 A1	Backband 79	984 A1	Backband 80	1145 T2	Casing 57	1384-T2	Casing 57
803 T2	Symm Casing 68	985 A1	Backband 80	1146 T2	Casing 58	1438 T2	Colonial Casing 46
804 T3	Sym Casing 66	990 A1	Backband 80	1148 T2	Casing 58	1439 T2	Colonial Casing 46
806 T2	Casing 58	1001 T4	Fluted Casing 69	1149 T2	Casing 58	1444 T3	Casing 46
807 P2	Apron 74	1020 A1	Backband 80	1150 T2	Casing 42	1460 T2	Casing 59
808 T2	Casing 59	1021 A1*	Backband 80	1151 T2	Casing 42	1461 T2	Casing 56
820-T2	Symm Casing 67	1022 A1*	Backband 80	1152 T2	Casing 54	1462 T2	Casing 56
821 T2	Casing 54	1024 A1	Backband 80	1153 T2	Casing 54	1463 T2	Casing 45
885 MV	Sill 78	1025 A1*	Backband 80	1154 T2	Casing 53	1464 T2	Apron/Misc 74
886 MV	Sill 78	1026 A1	Backband 79	1156 T2	Casing 55	1467 T2	Casing 55
887 MV	Sill 78	1027 A1	Backband 80	1157 T2	Casing 53	1504 L2	Lintel 70
888 MV*	Sill 78	1028 P2	Backband 80	1158 T2	Casing 53	1507 L2	Lintel 70



Profile #	Pg #	Profile #	Pg #	Profile #	Pg #	Profile #	Pg #
1509 L2	Lintel 70						
1521 T2	Sym Casing 69						
1523 T2	Sym Casing 67						
1524-T2	Reeded Casing 68						
1526 T2	Symm Casing 67						
1527 T3	Sym Casing 63						
1528 T4	Sym Casing 63						
1529 T4	Sym Casing 63						
1530 T2	Casing 52						
1531B-T4	Sym Casing 67						
1531 T4	Sym Casing 65						
1532 T3	Sym Casing 66						
1560 T3	Casing 51						
1561 T2	Casing 52						
1570 T3	Sym Casing 65						
1580 -T4	Casing 48						
1701-S1	Stop 78						
1720 T3	Symm Casing 66						
1804 T2	Casing 60						
1911 L2	Lintel 70						
1912 L2	Lintel 70						
1913 L2	Lintel 73						
1914 L2	Lintel 71						
1916 L2	Lintel 73						
1917B-L1	Lintel 72						
1917 L1	Lintel 72						
1919 L2	Lintel 72						
1920 L2	Lintel 73						
1922 A1	Backband 80						
2815-T2	Symmetrical Casing 67						
3120 T2	Casing 52						
3121 T3	Casing 51						
3122 T2*	Casing 44						
3123-T3	Casing 48						
3131-T2	Casing 44						
3133 T2	Casing 53						
3134B-T2	Casing 44						
3134B-T4	Casing 44						
3134 T4	Casing 44						
3135 T3	Casing 50						
3136 T4	Casing 48						
3137 T4	Casing 52						
3138 T3	Casing 44						
5100B-H4	Architrave 77						
5100-H4	Architrave 77						
93041-A1	Backband 80						

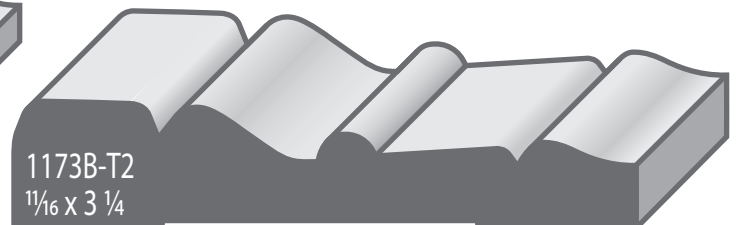
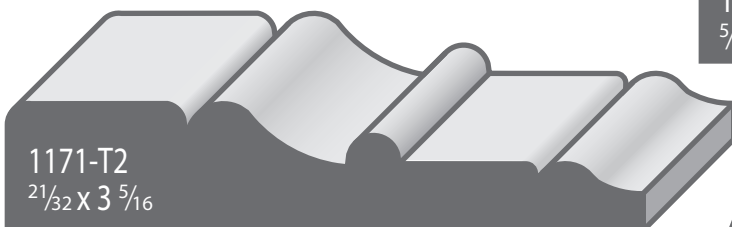
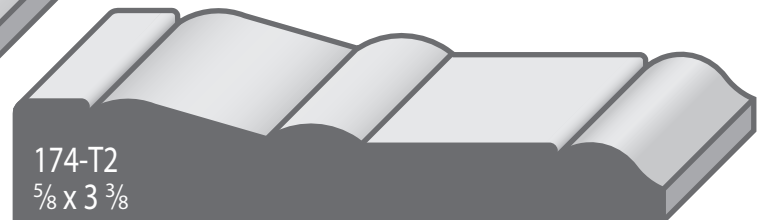
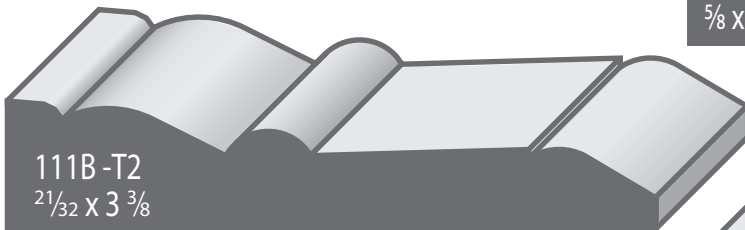
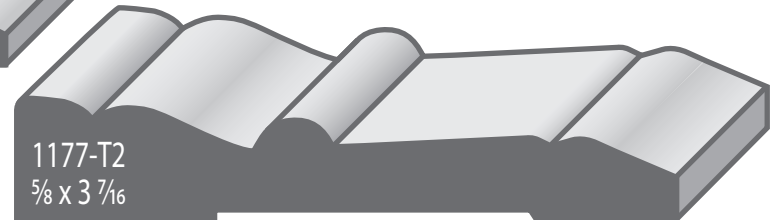
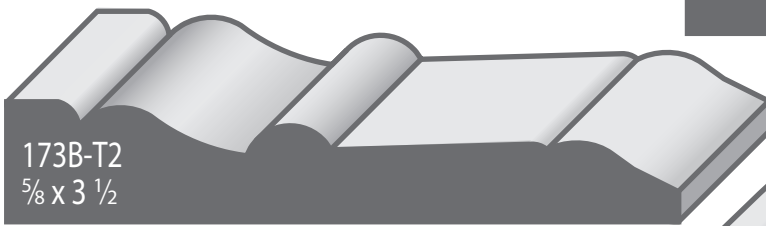
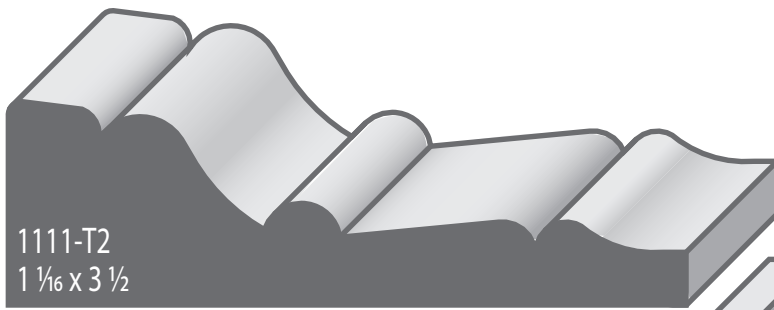

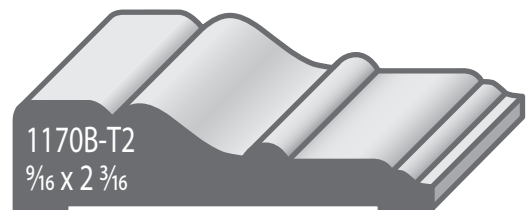
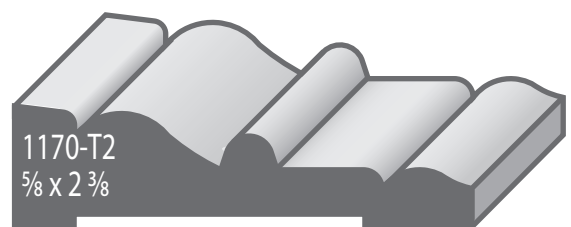
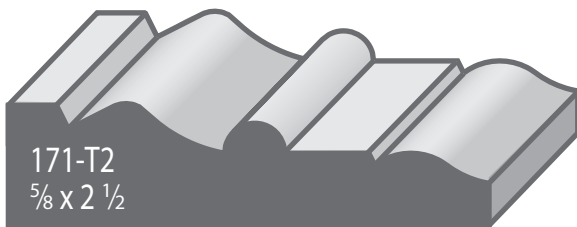
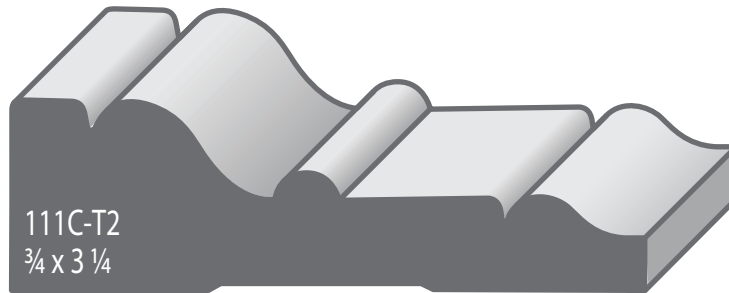
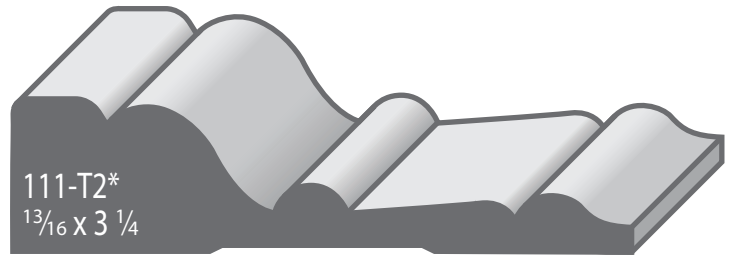
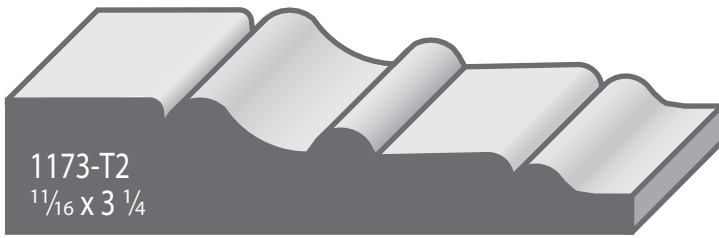

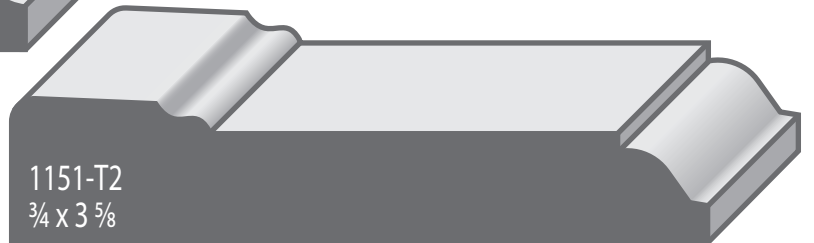
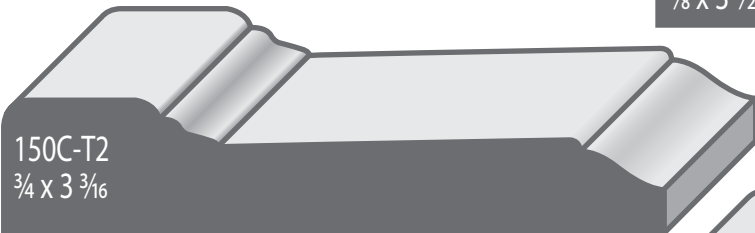
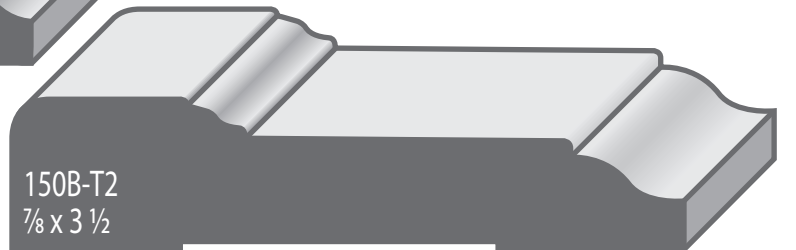
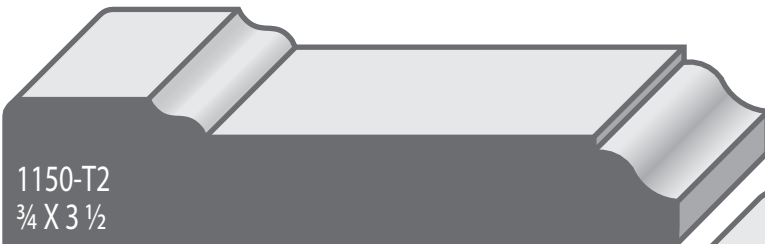
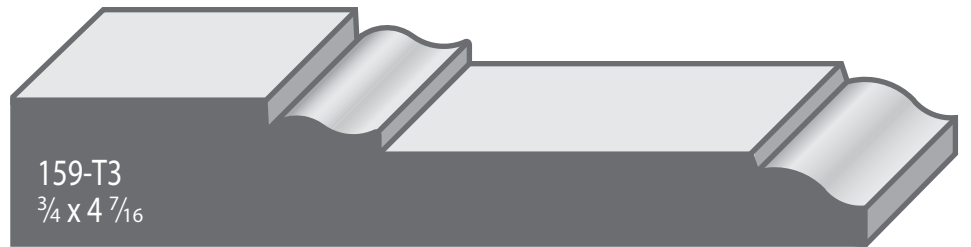
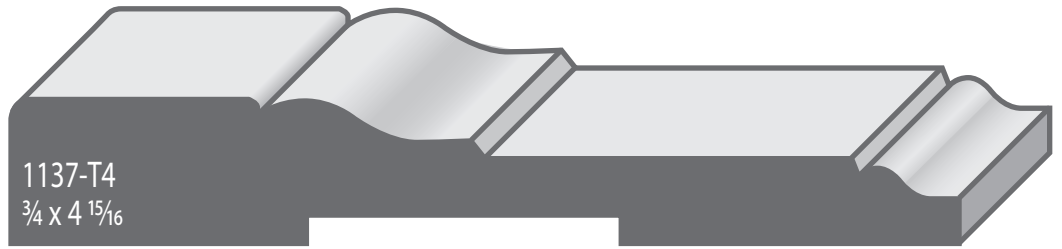



533B-T2
 $\frac{3}{4} \times 3 \frac{7}{16}$



533-T2
 $1 \frac{1}{16} \times 3 \frac{11}{32}$

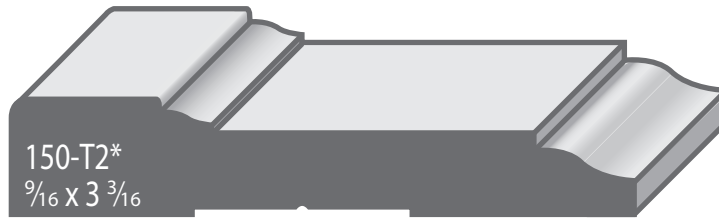

150-T2*
 $\frac{9}{16} \times 3 \frac{3}{16}$

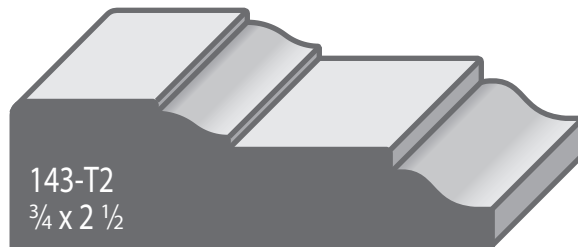

143-T2
 $\frac{3}{4} \times 2 \frac{1}{2}$

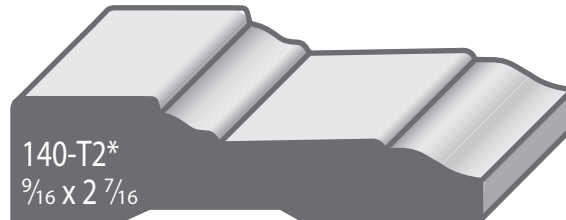

140-T2*
 $\frac{9}{16} \times 2 \frac{7}{16}$

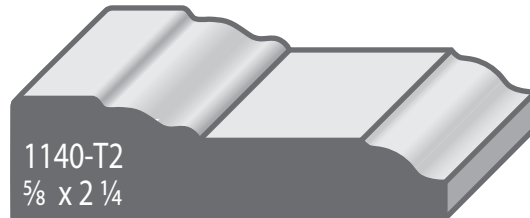

1140-T2
 $\frac{5}{8} \times 2 \frac{1}{4}$

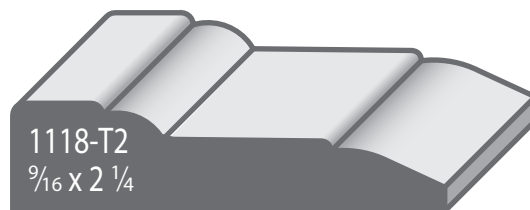

1118-T2
 $\frac{9}{16} \times 2 \frac{1}{4}$

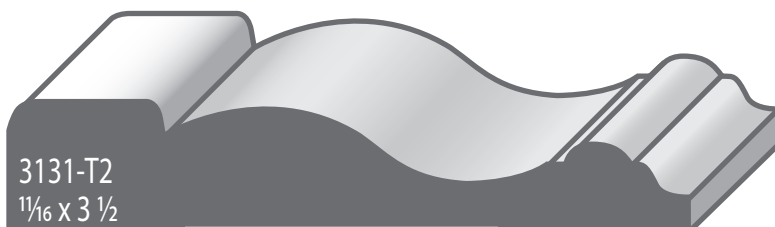
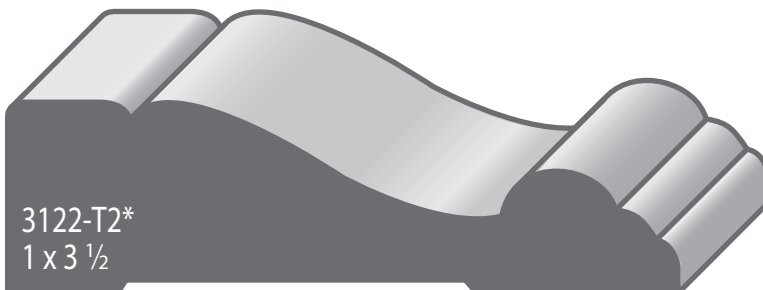
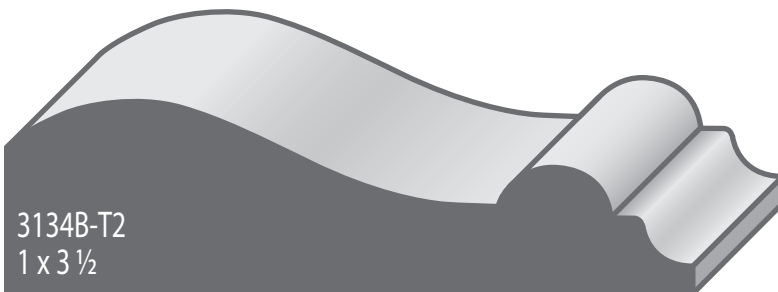
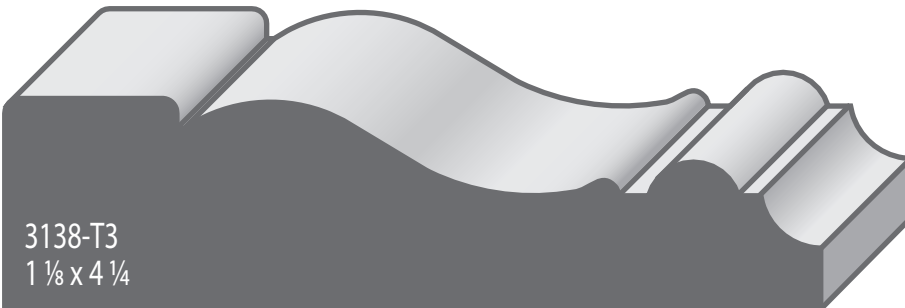
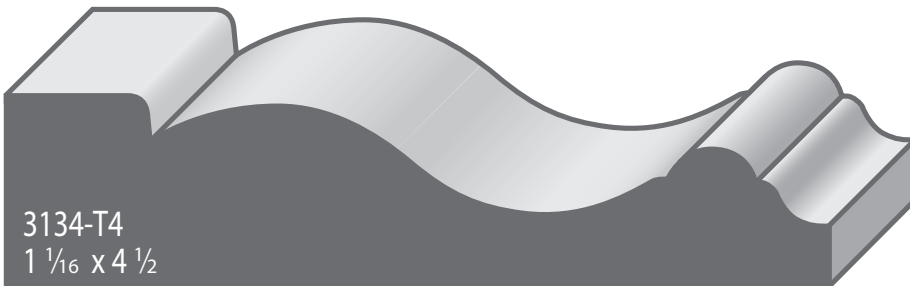
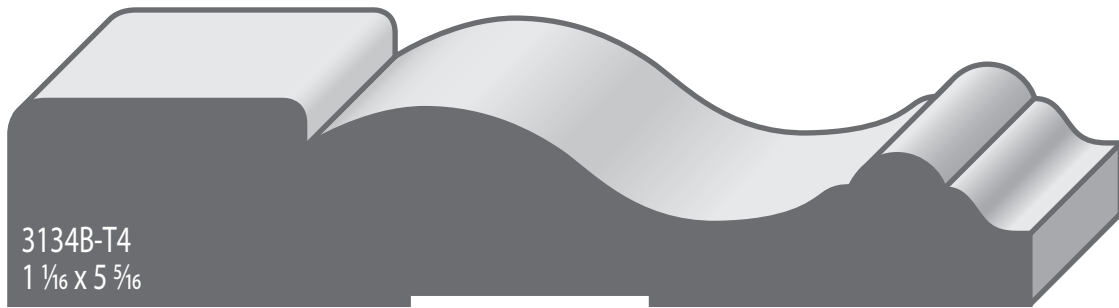

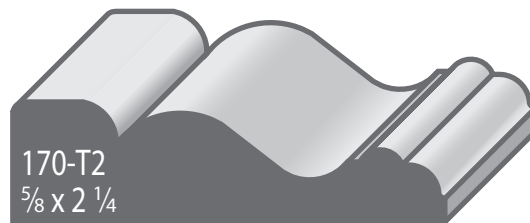
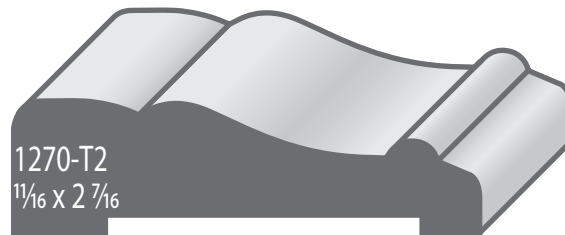
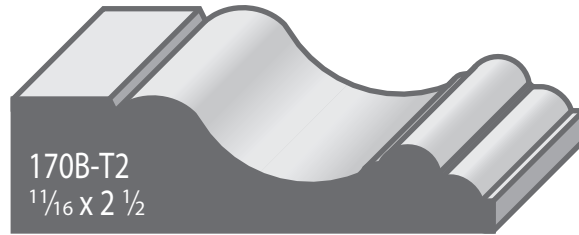
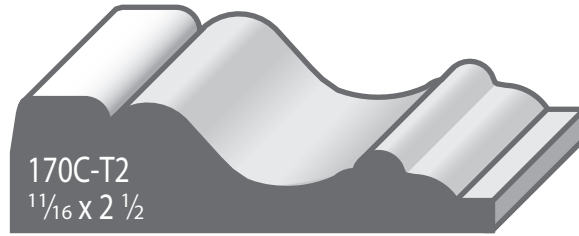

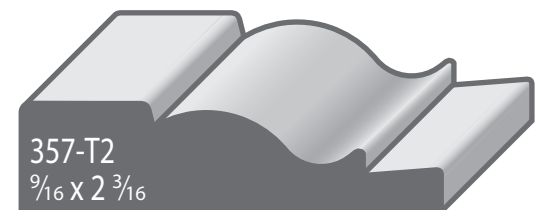
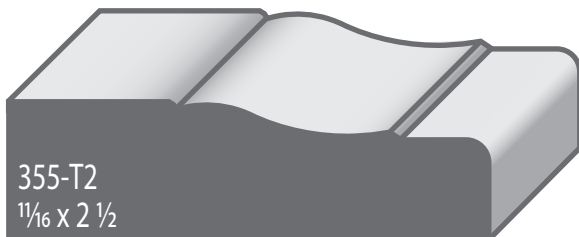
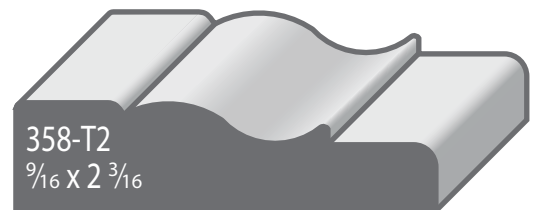
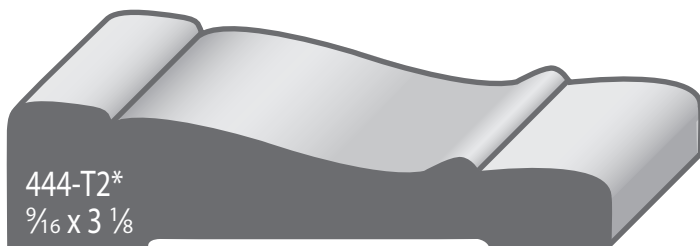
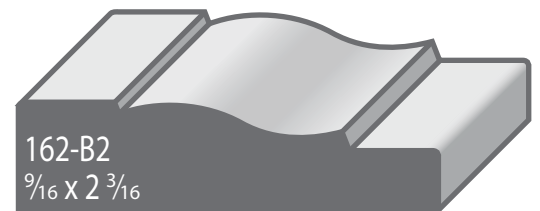
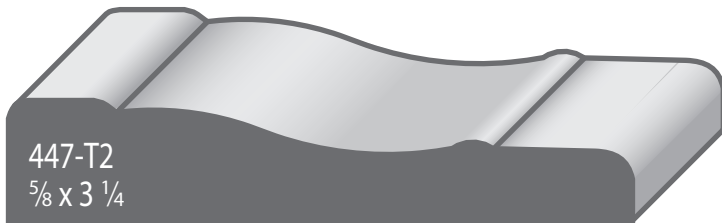
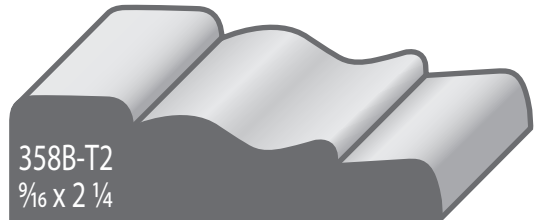
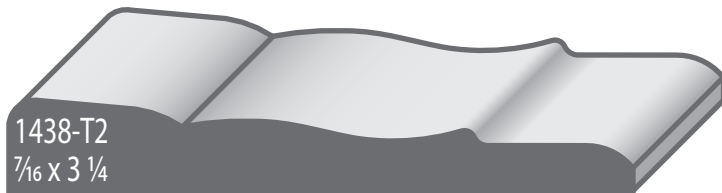
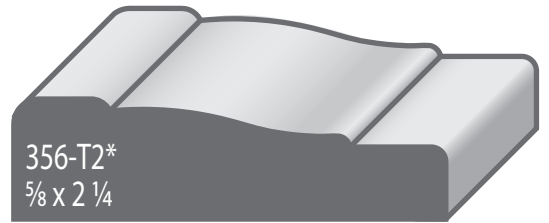
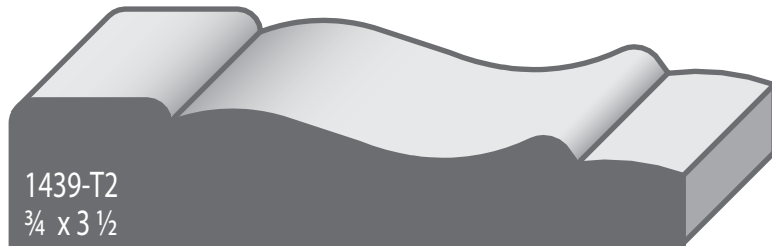
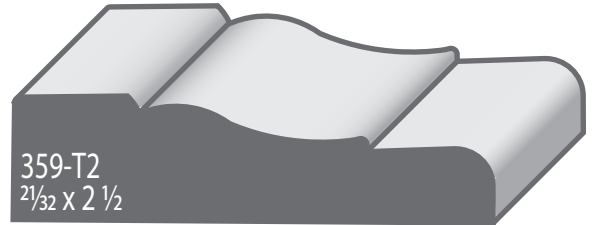
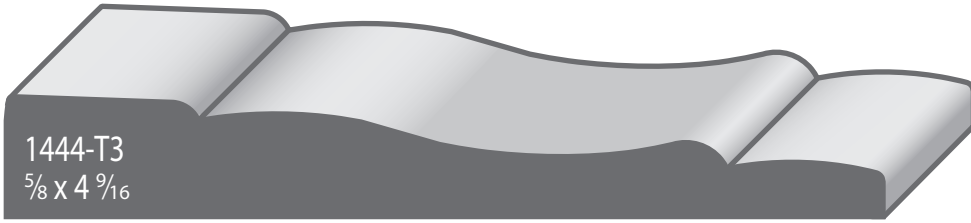

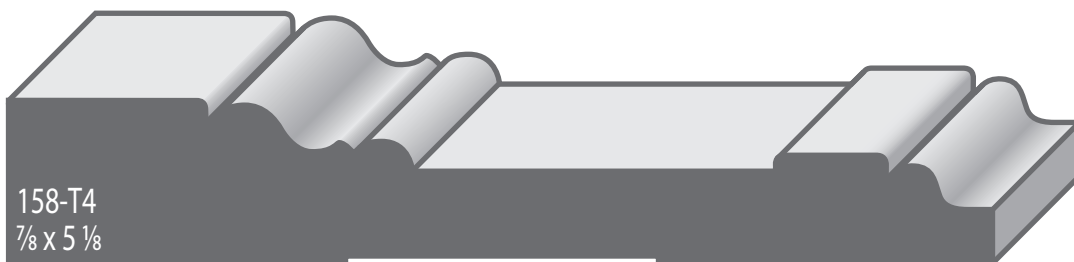
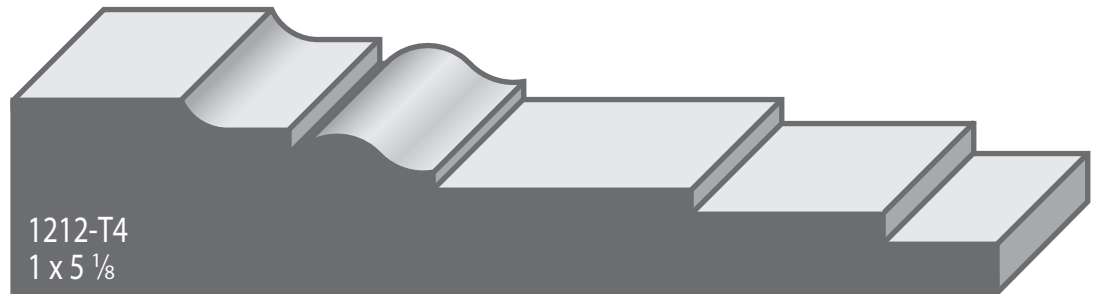
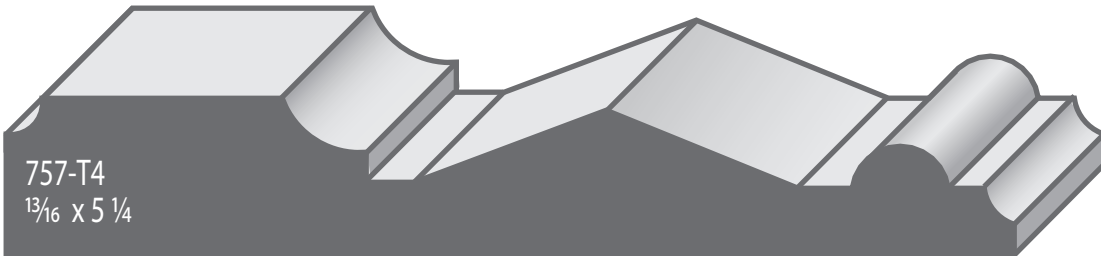
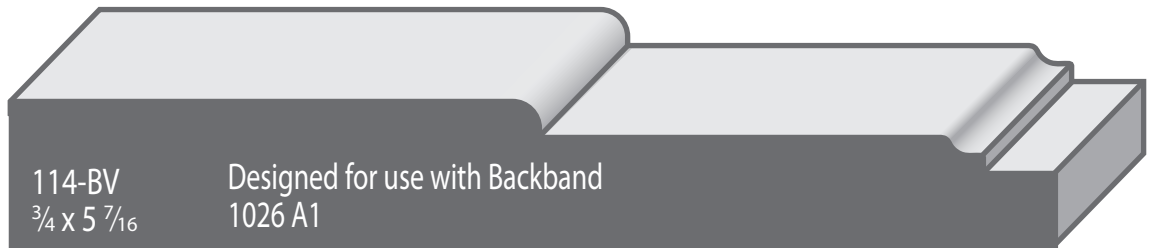
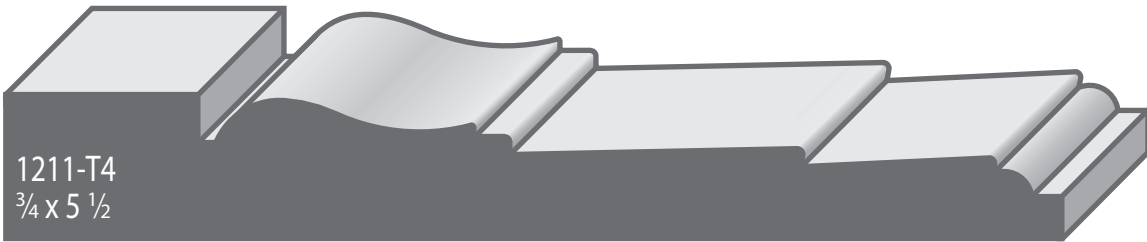
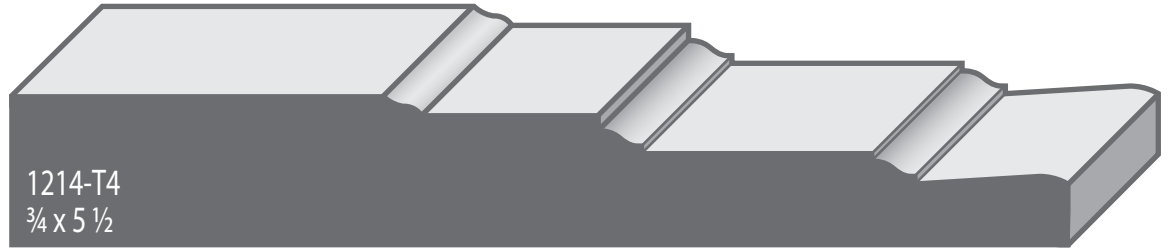

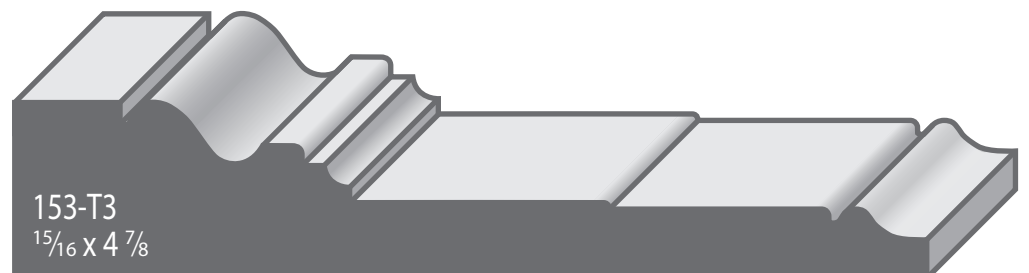
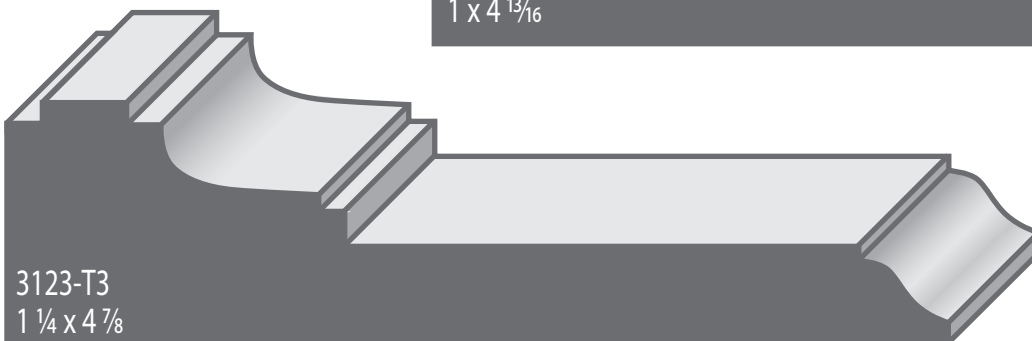
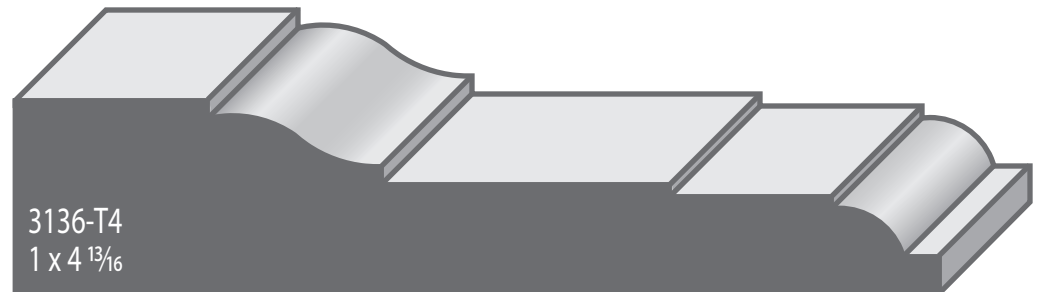
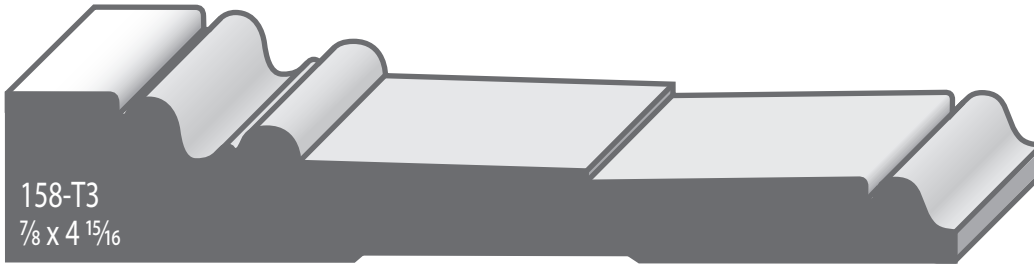
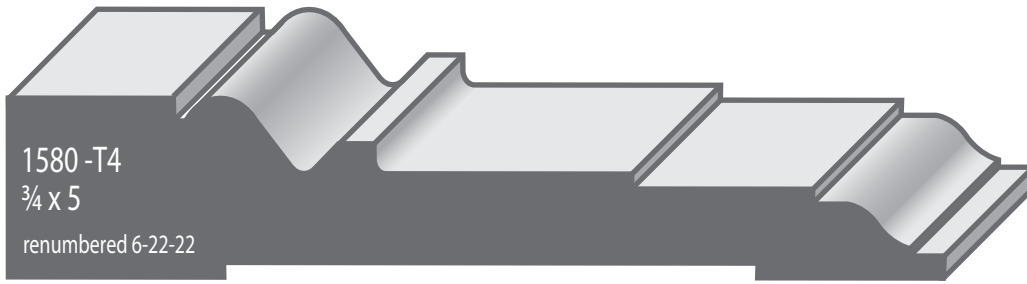

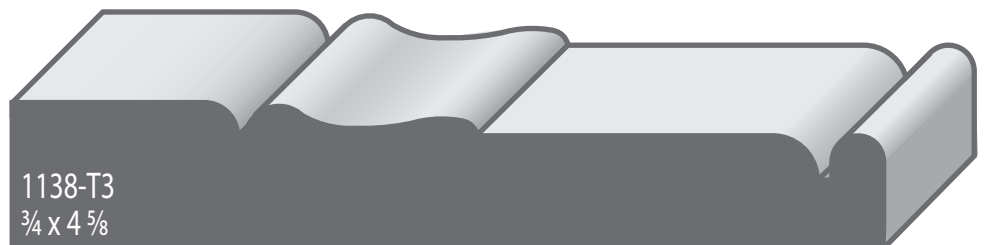
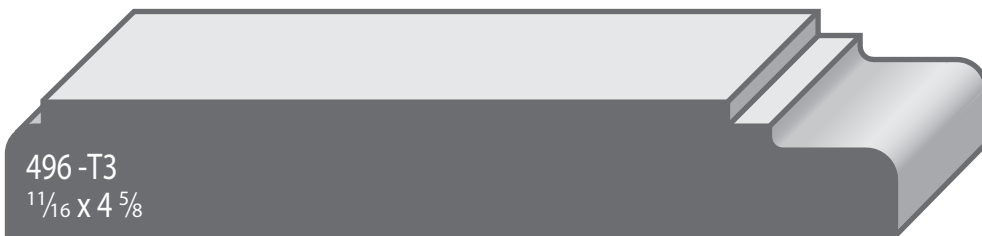
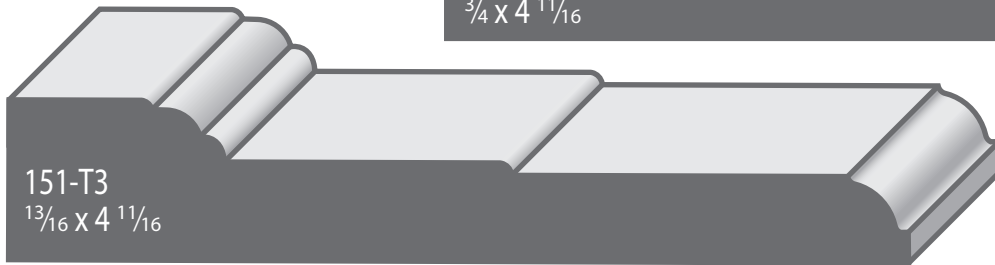
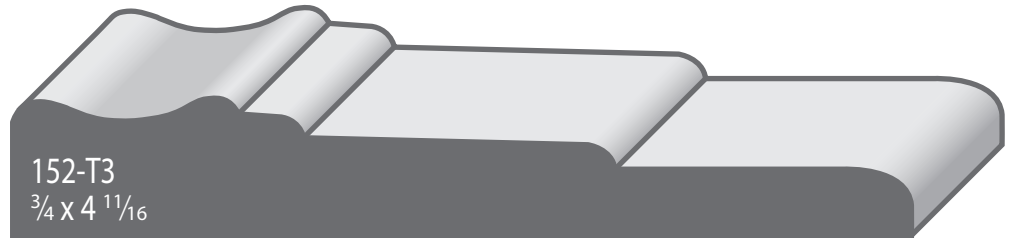
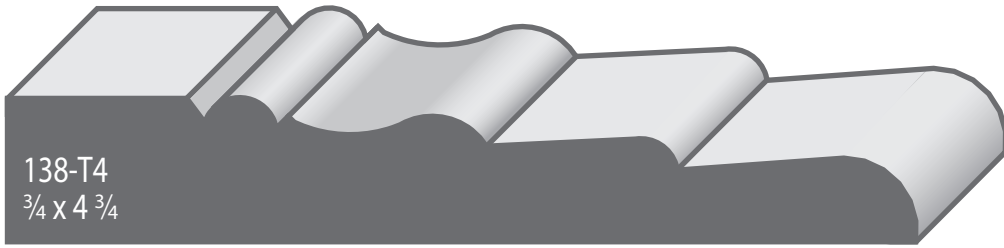

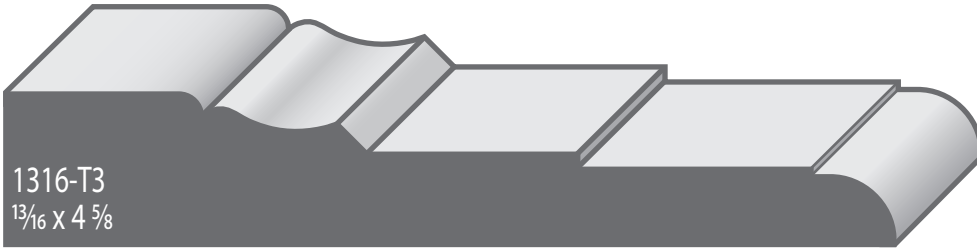

1316-T3
1³/₁₆ X 4 5/₈

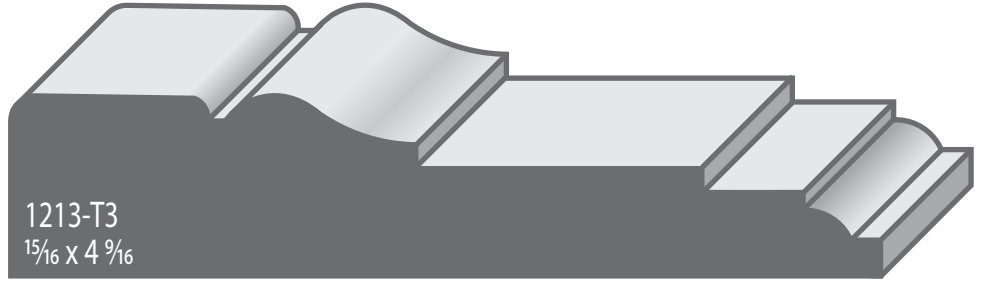

1213-T3
1⁵/₁₆ X 4 9/₁₆

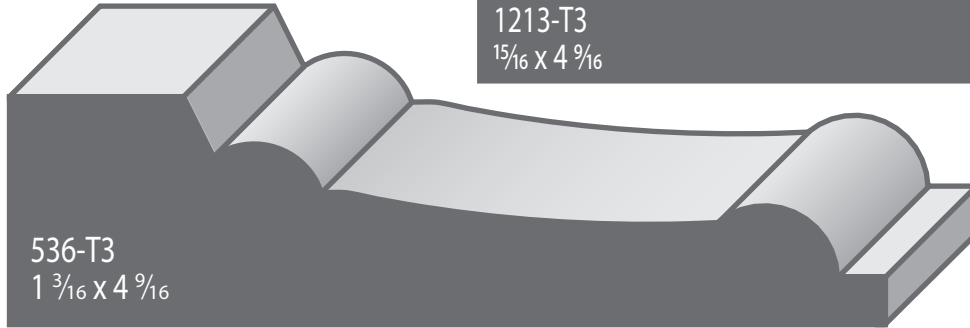

536-T3
1 3/₁₆ X 4 9/₁₆

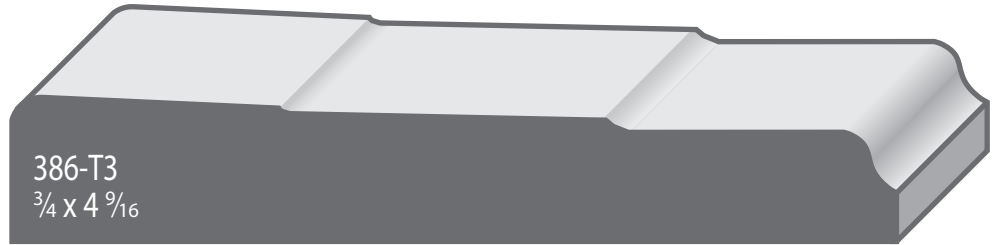

386-T3
3/₄ X 4 9/₁₆



534-T3
2⁷/₃₂ X 4 9/₁₆



177B-T3
3/₄ X 4 9/₁₆

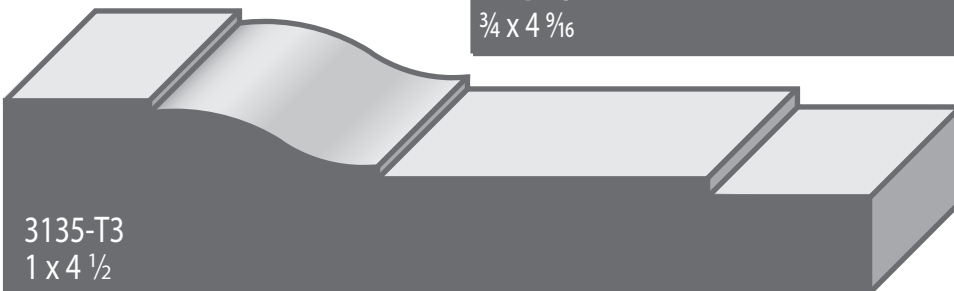

3135-T3
1 X 4 1/₂

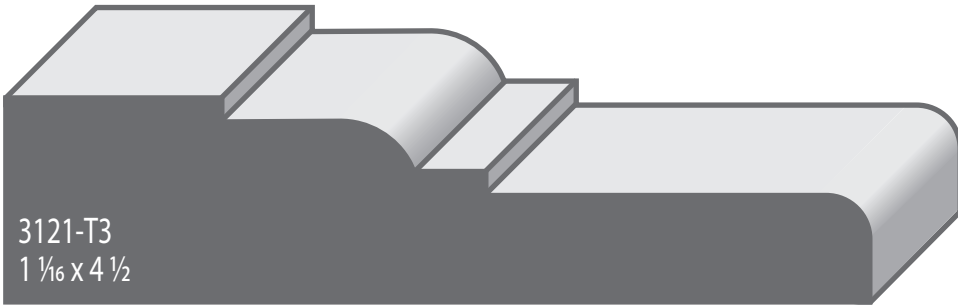

3121-T3
1 1/16 x 4 1/2

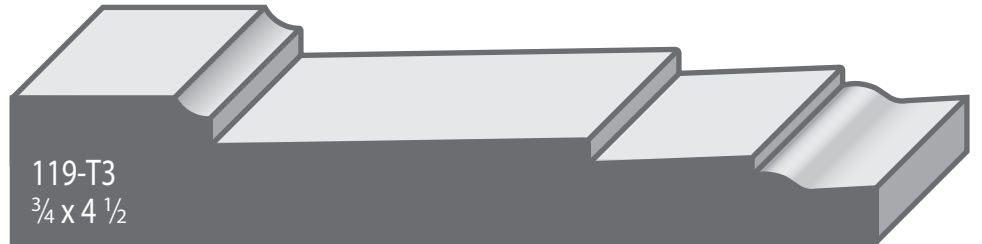

119-T3
3/4 x 4 1/2



158B-T3
1 1/16 x 4 3/8



155-T3
3/4 x 4 1/4

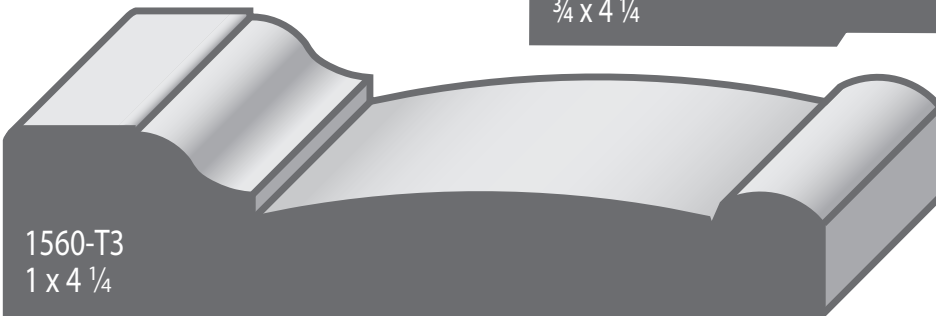

1560-T3
1 x 4 1/4

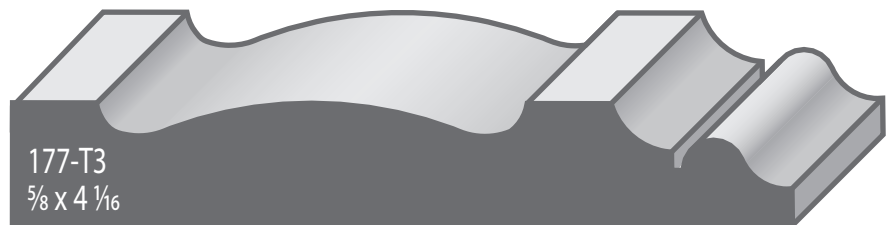

177-T3
5/8 x 4 1/16



1381-T3
1 3/16 x 4 1/16

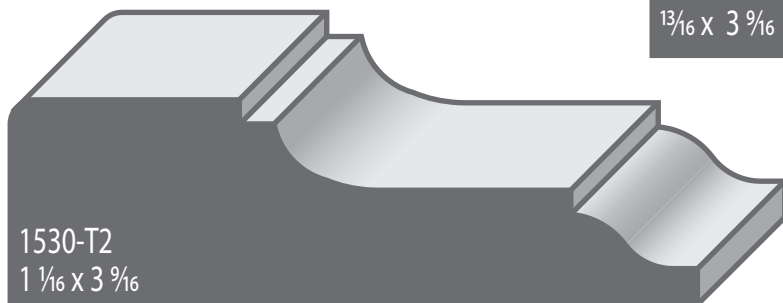
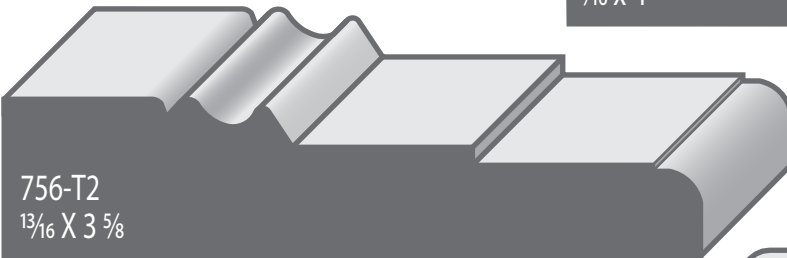
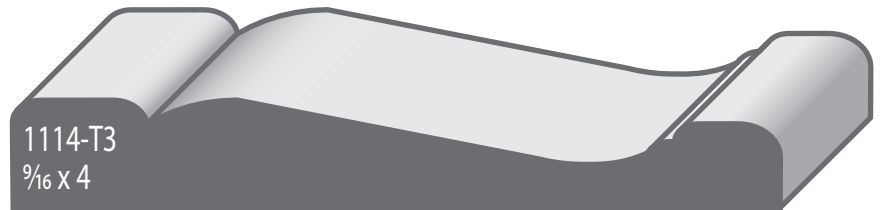
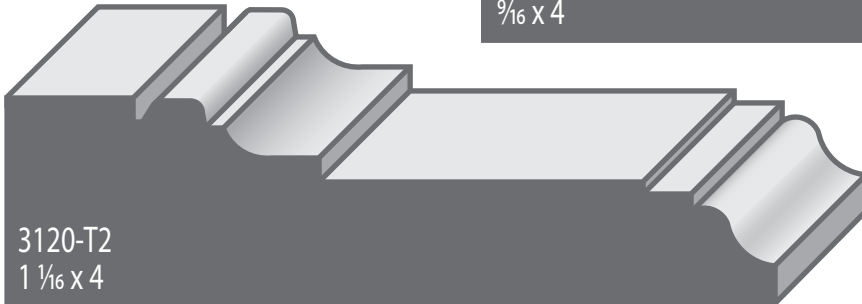
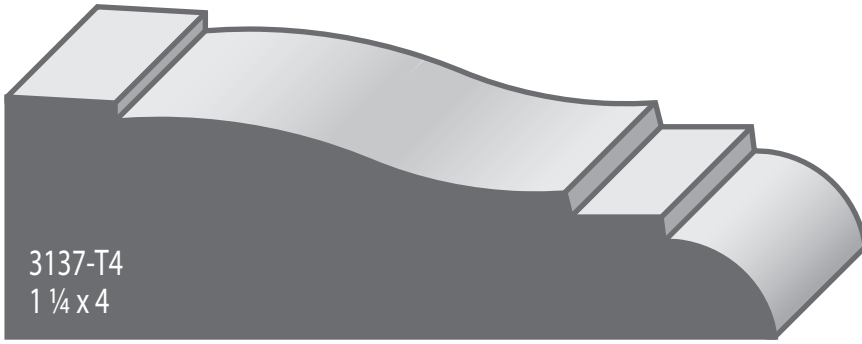

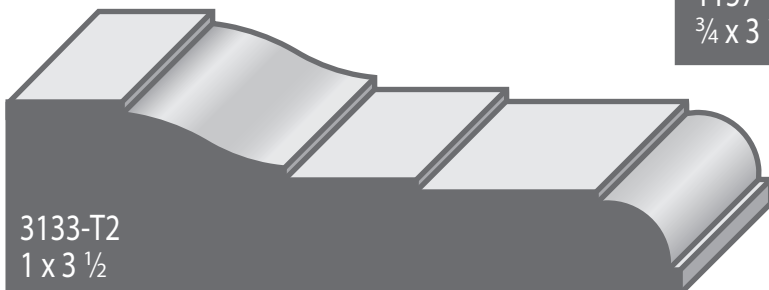
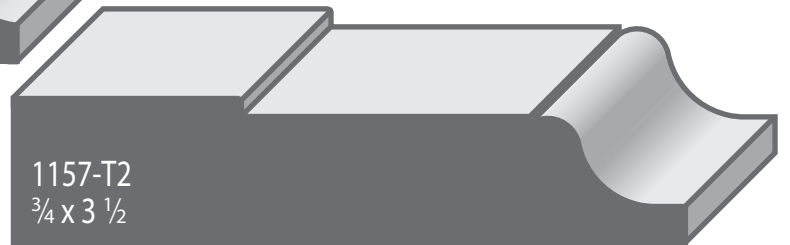
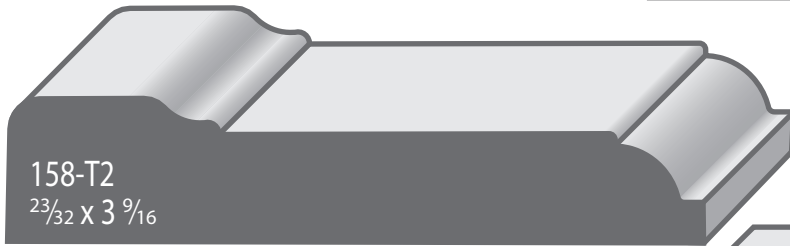
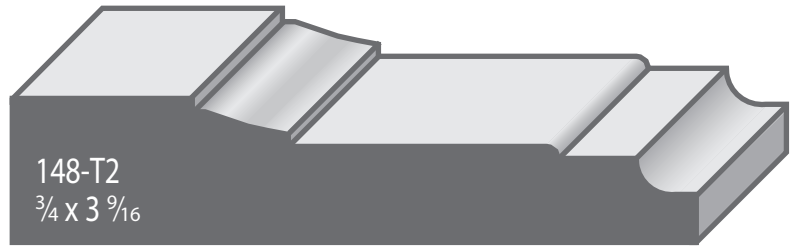

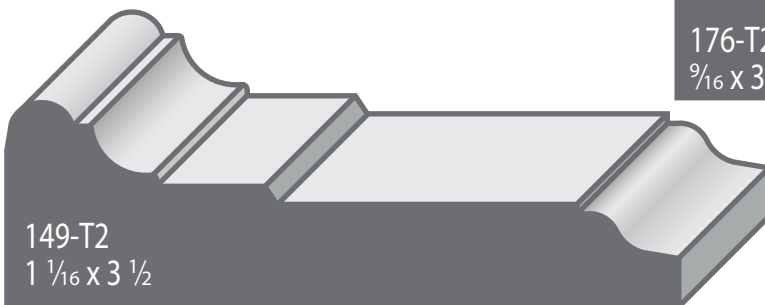
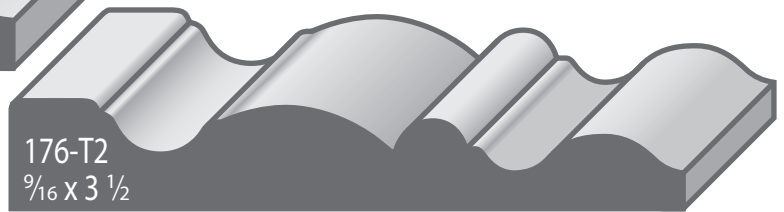
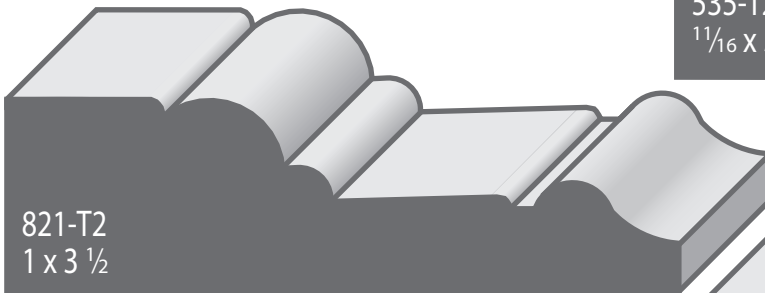
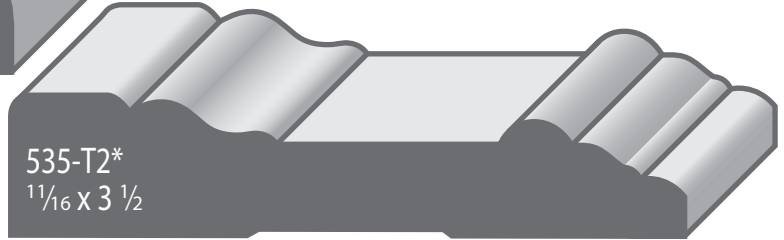
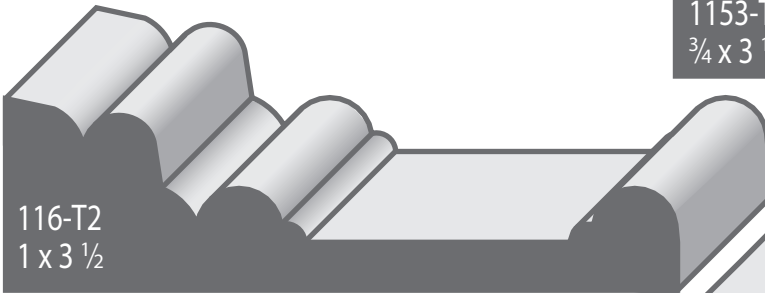
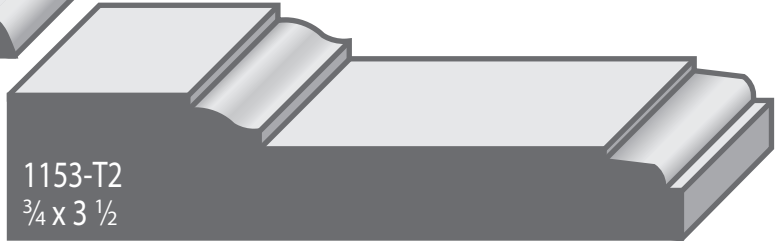
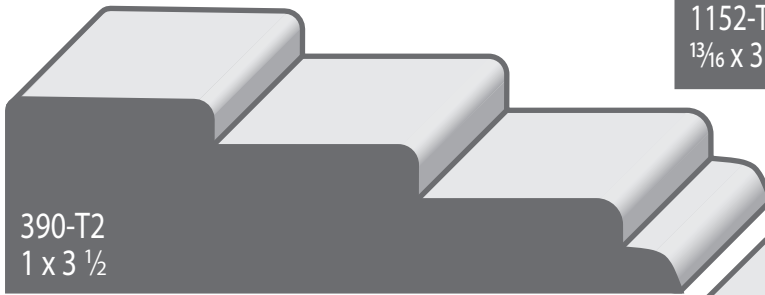
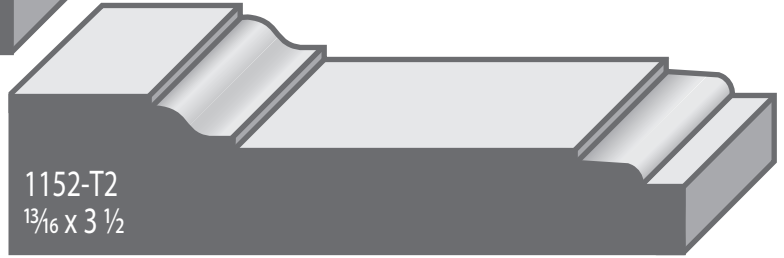
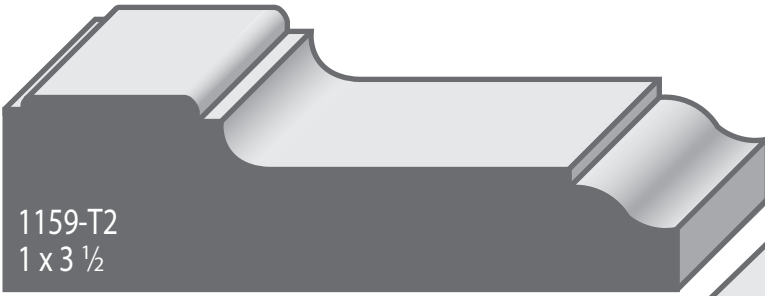

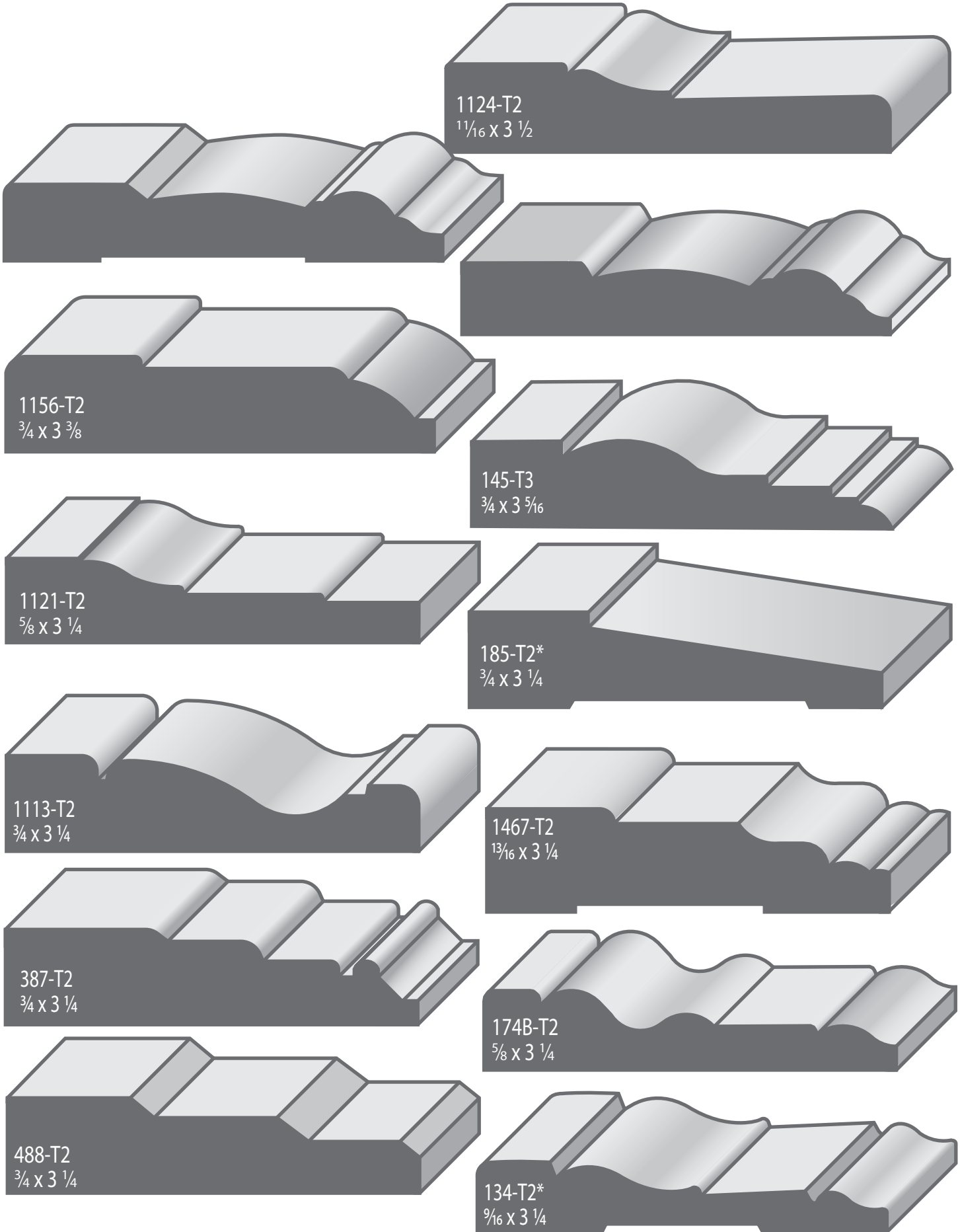

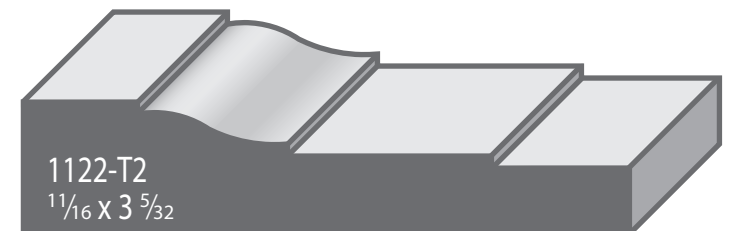
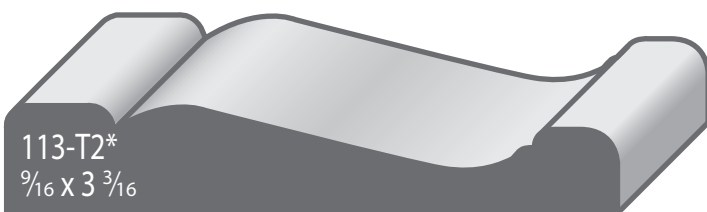
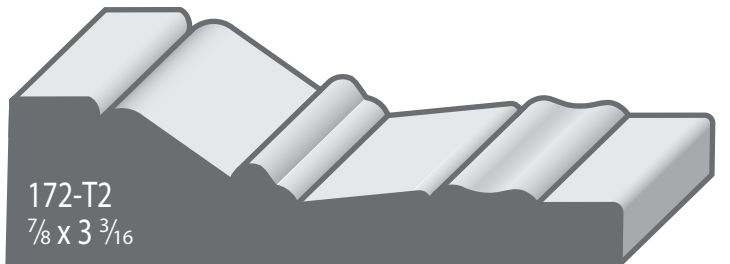
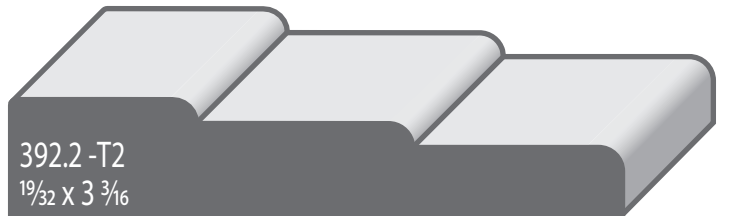
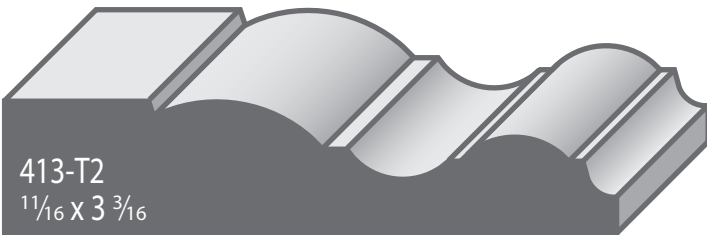
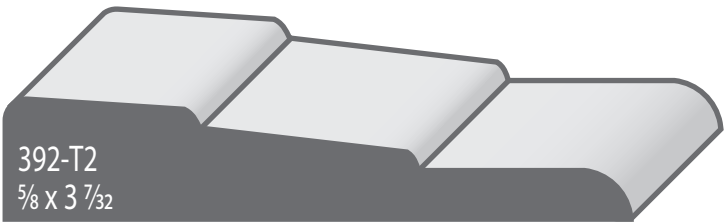
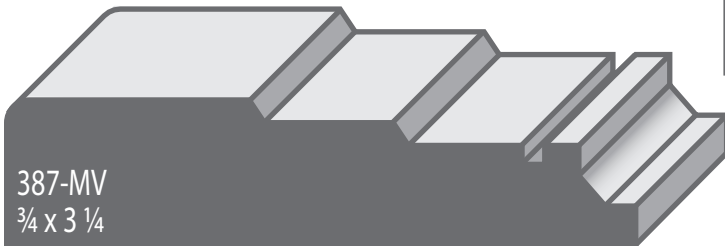
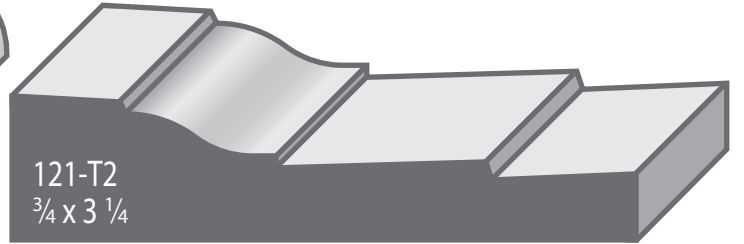
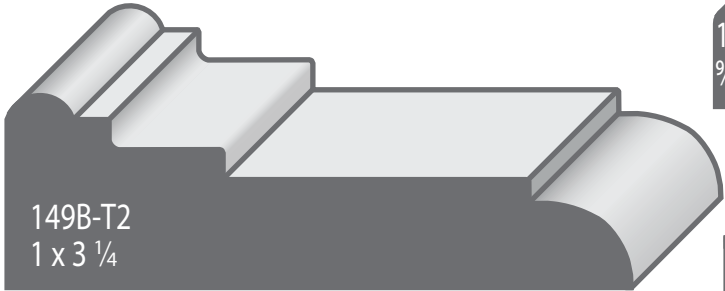
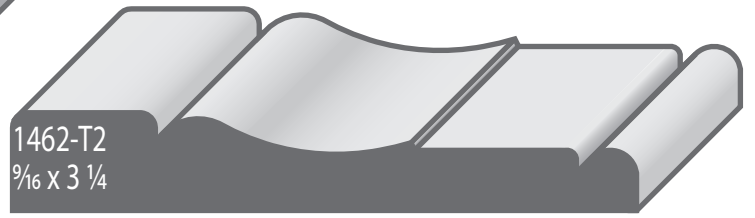
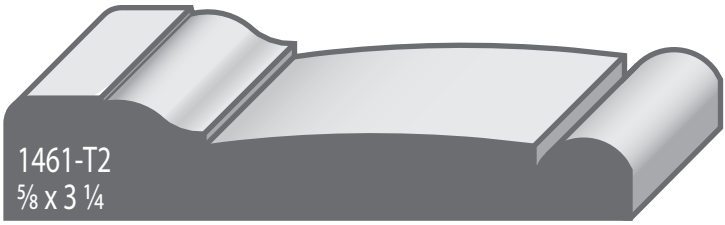

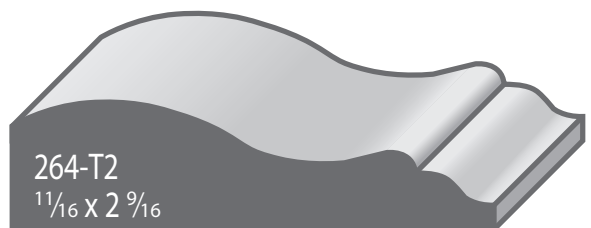
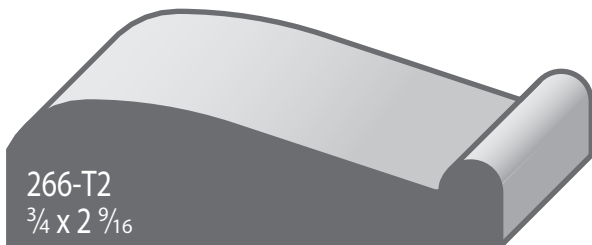
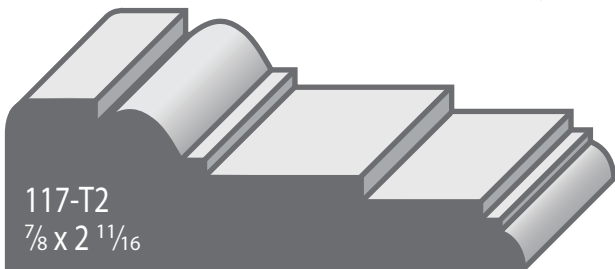
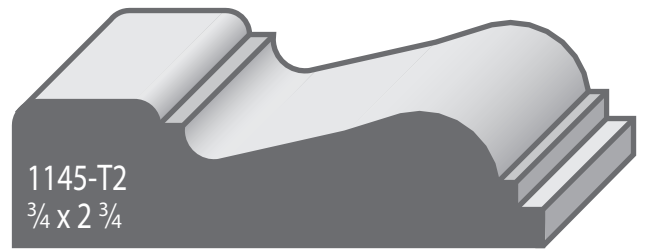
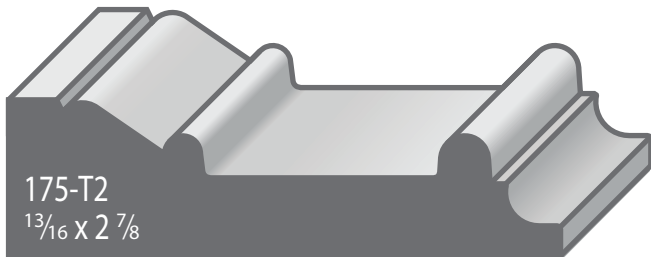
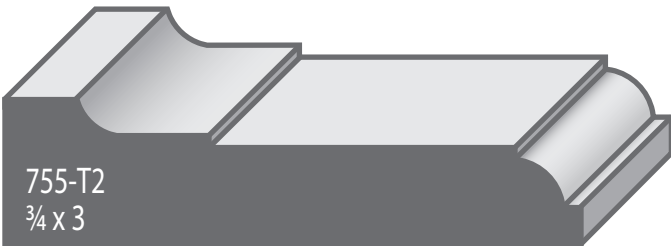
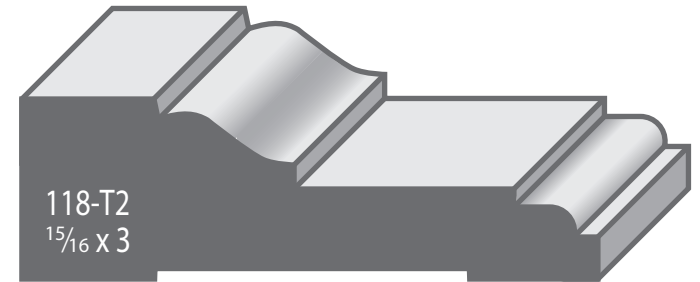
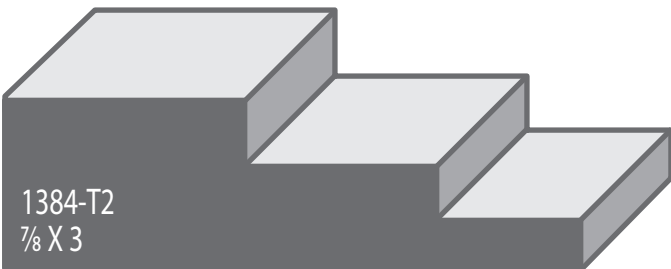
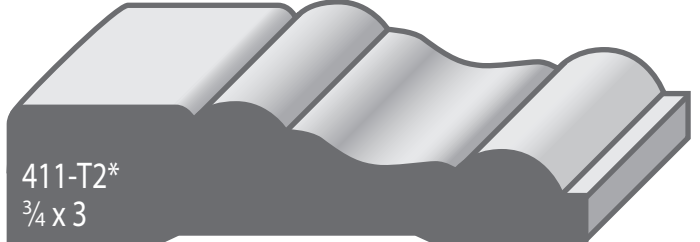
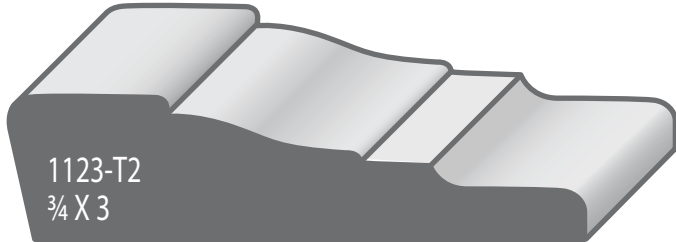
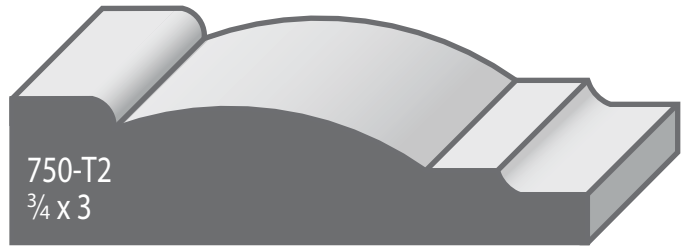

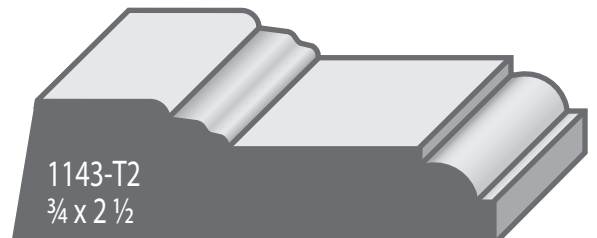
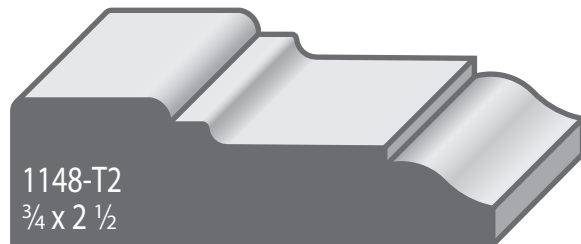
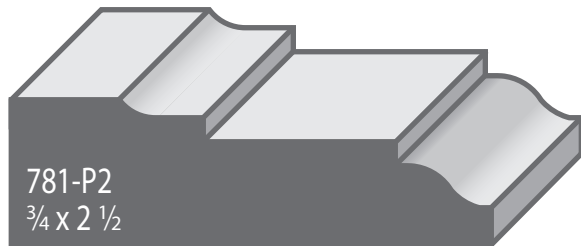
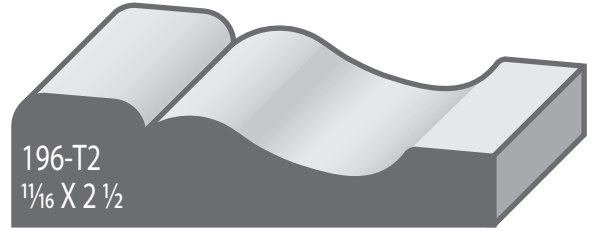
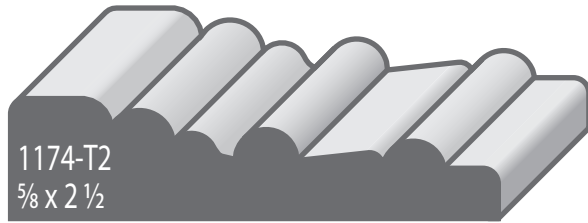
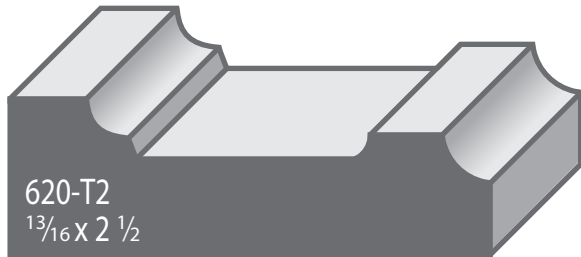
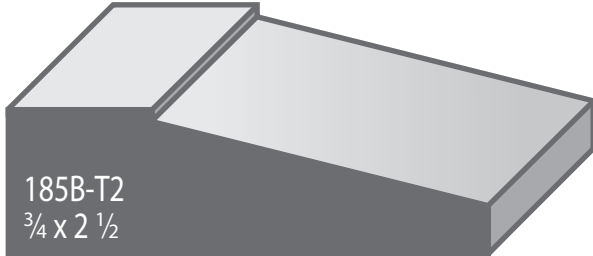
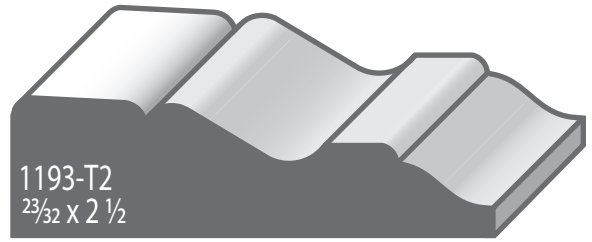

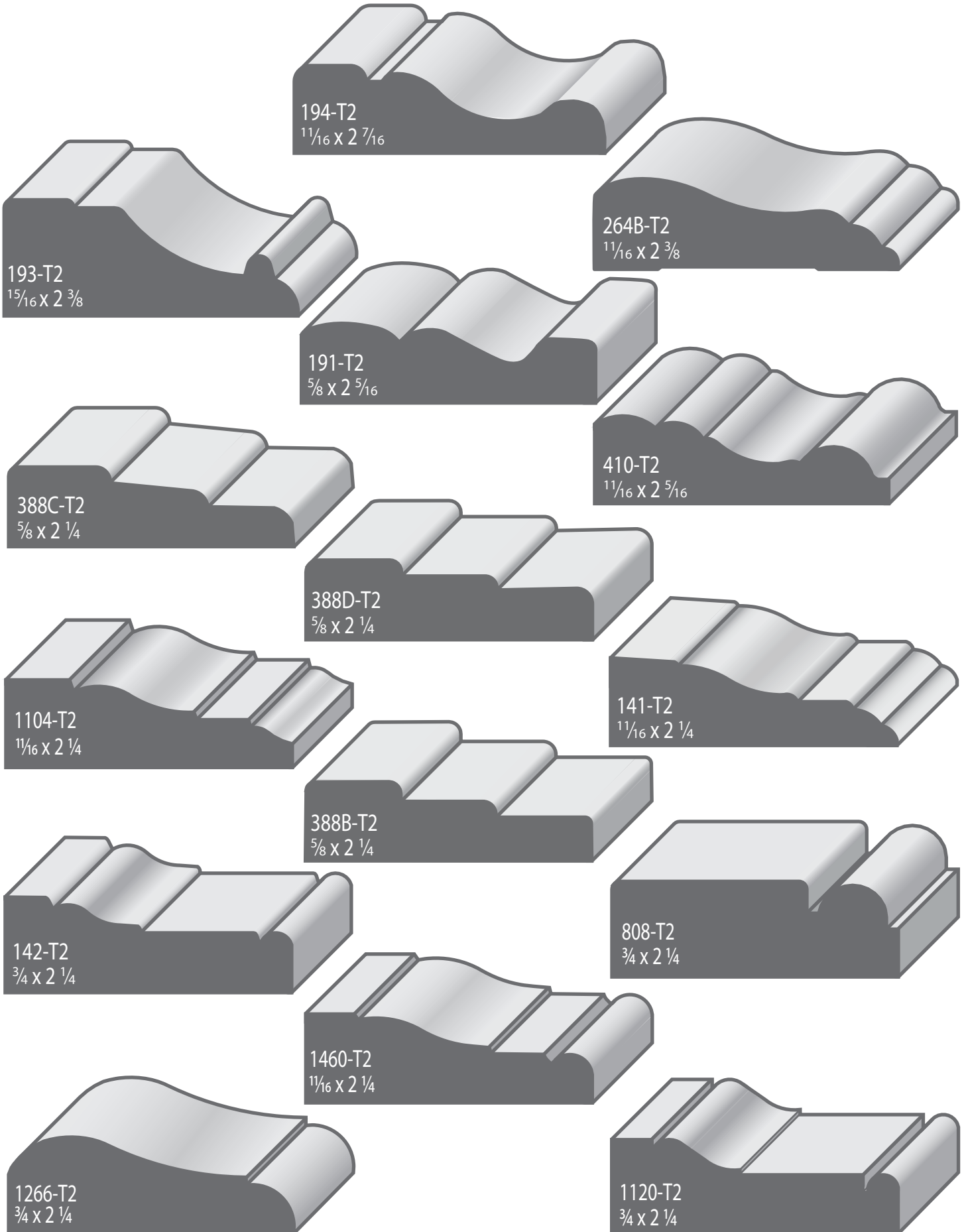

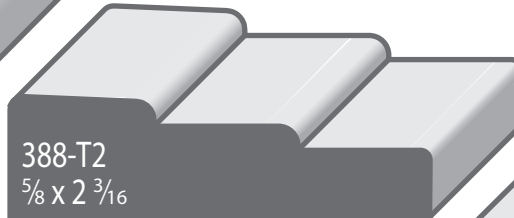
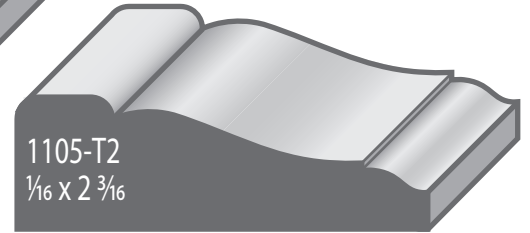
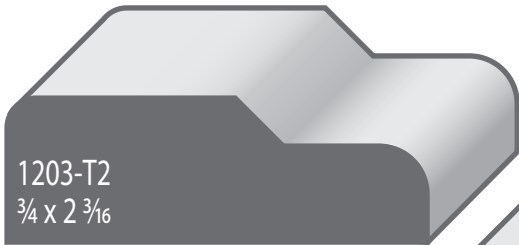
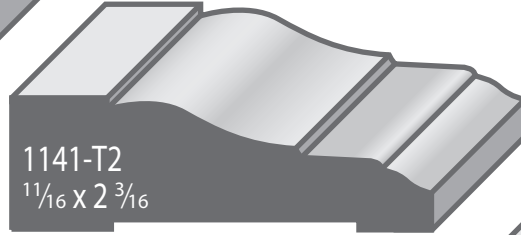
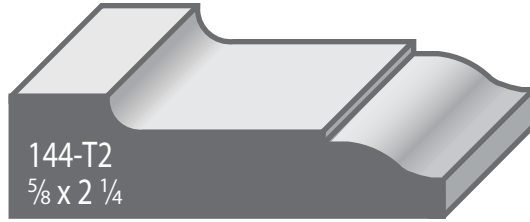
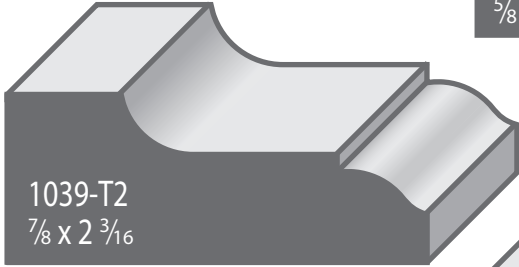

Pair with Plinth #1037 T2 and Base 331 BV

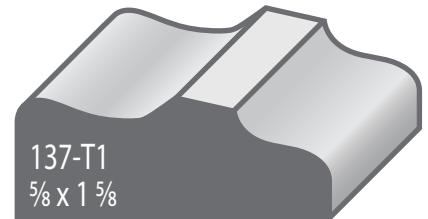
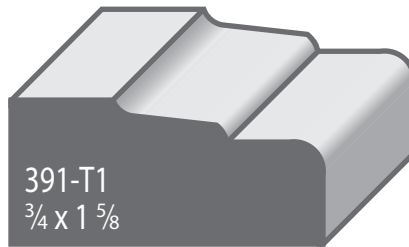

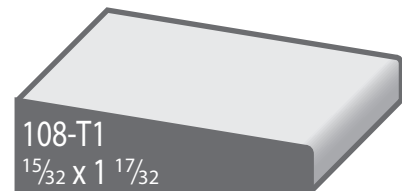
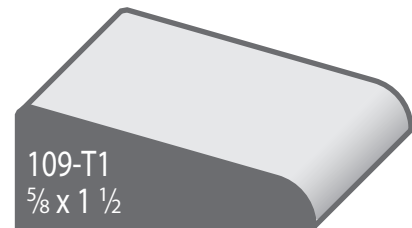
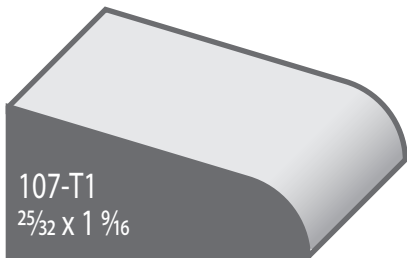
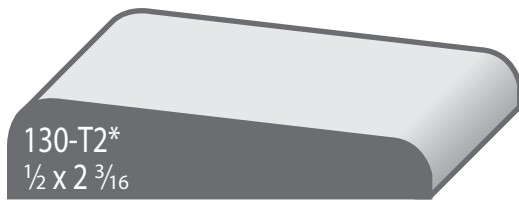
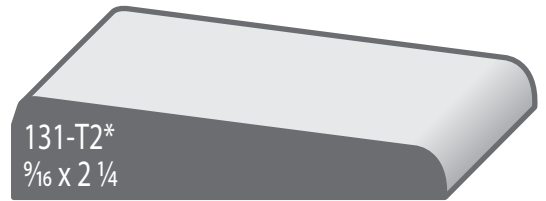
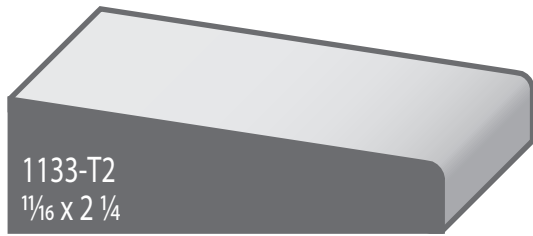
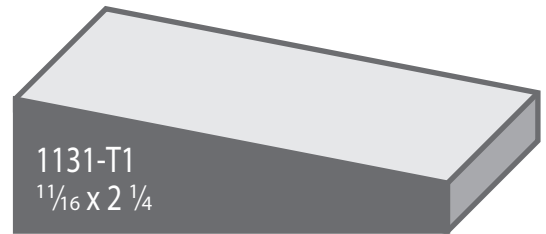
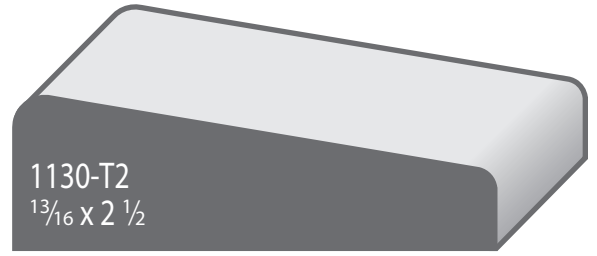
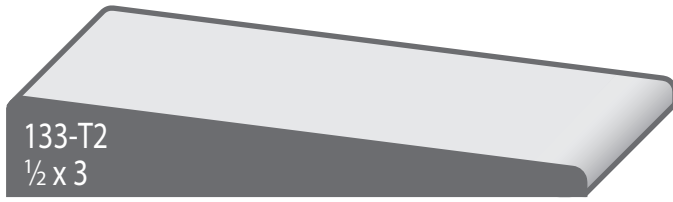

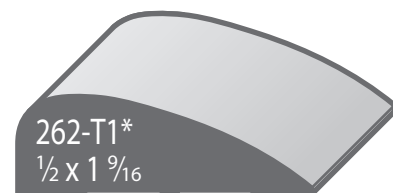
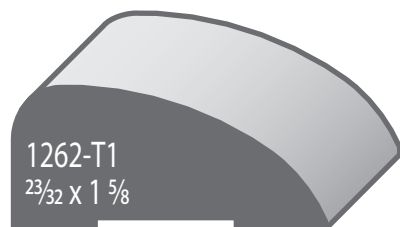
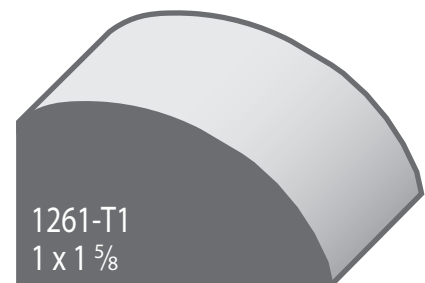
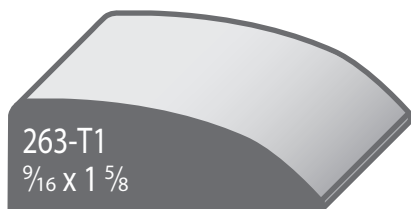
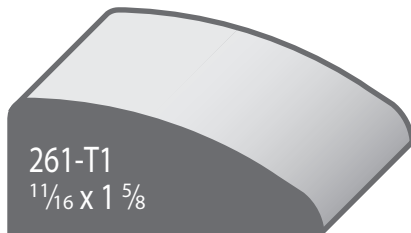
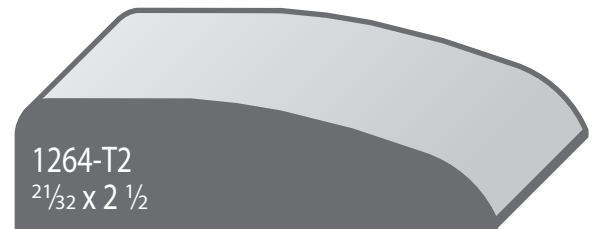

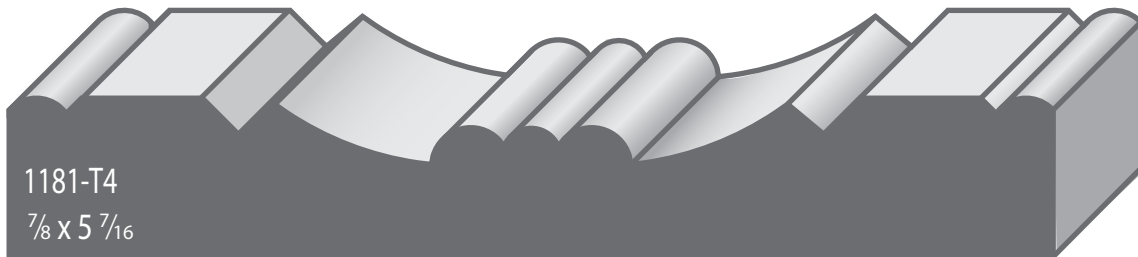
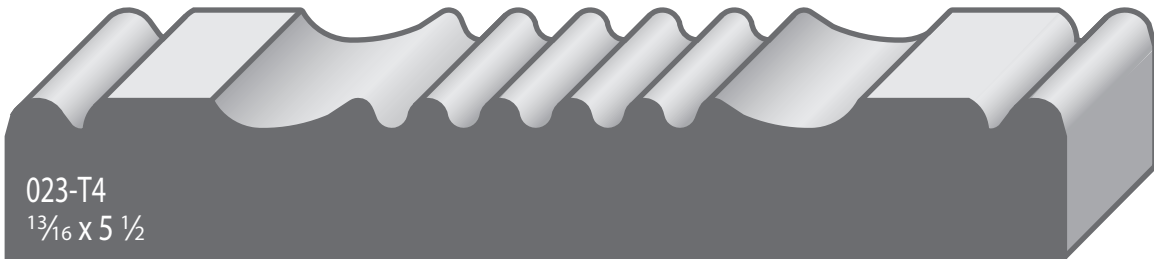

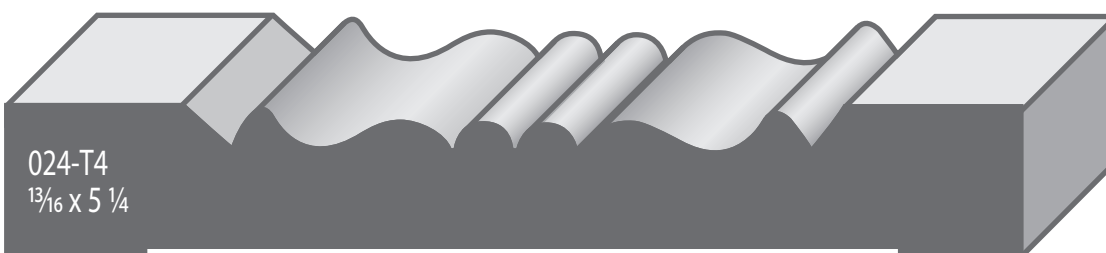
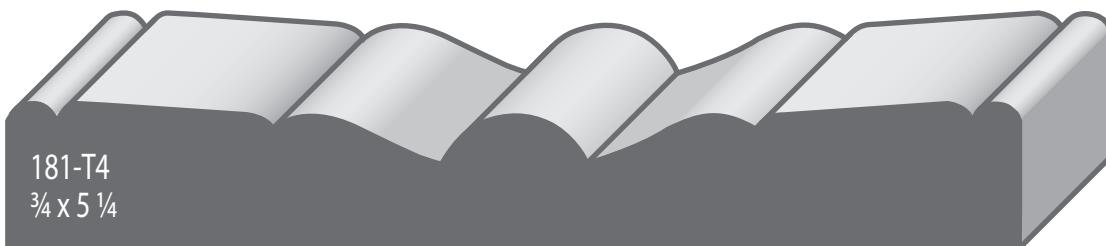
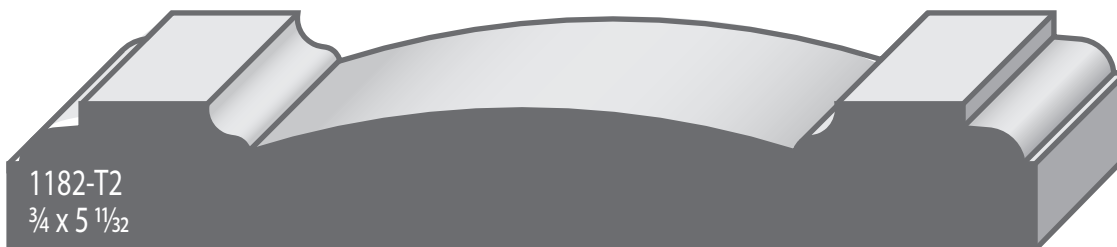
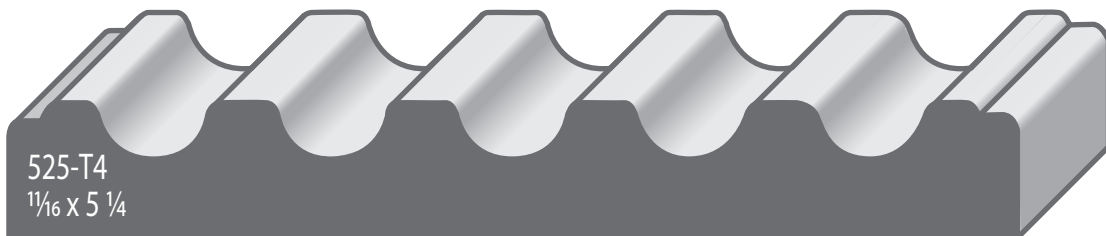
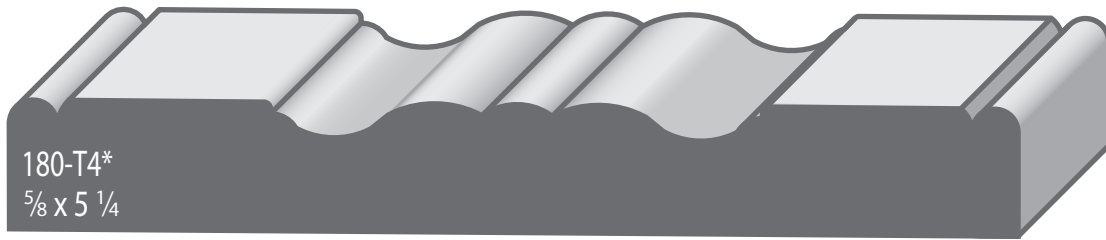

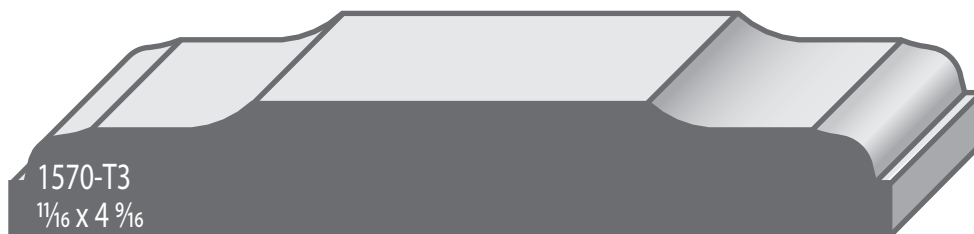
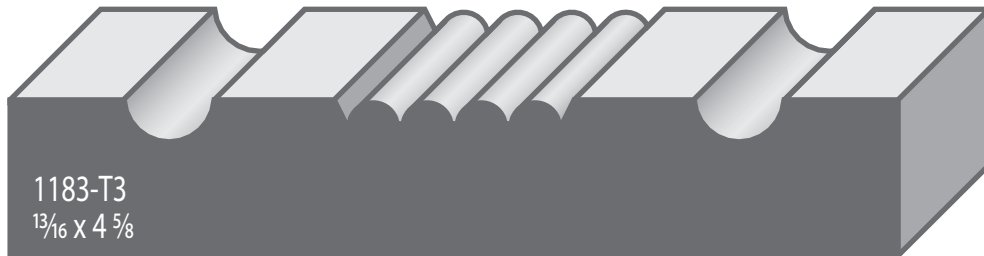
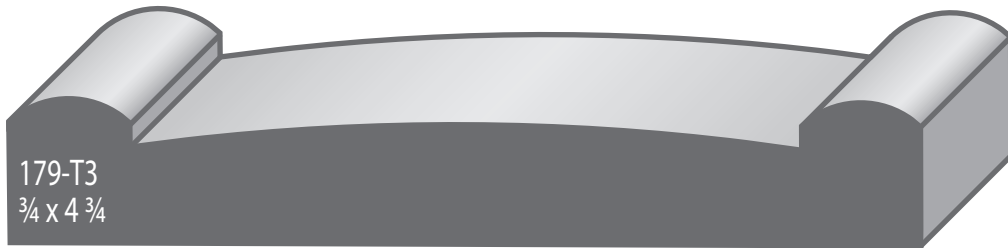
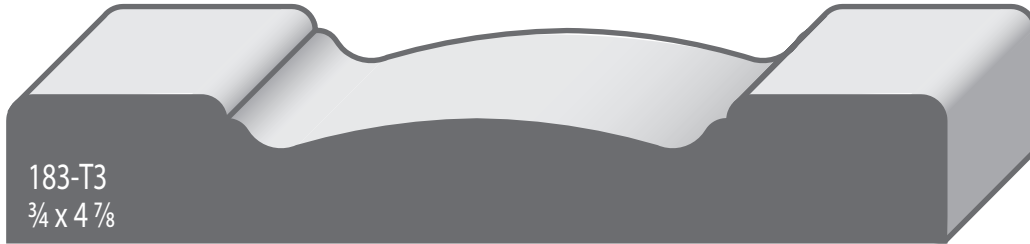
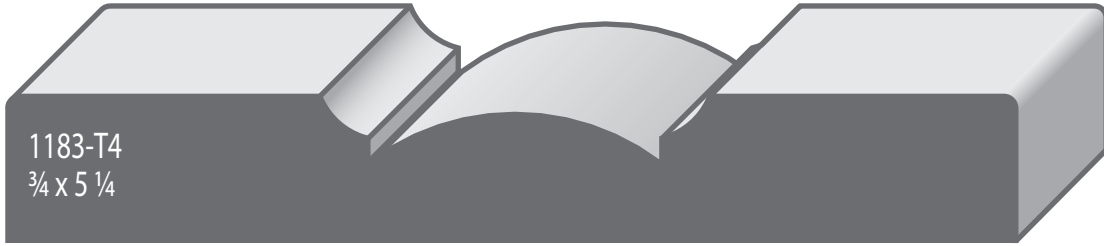

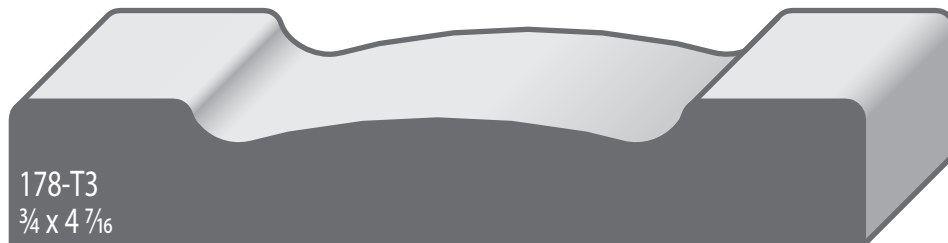
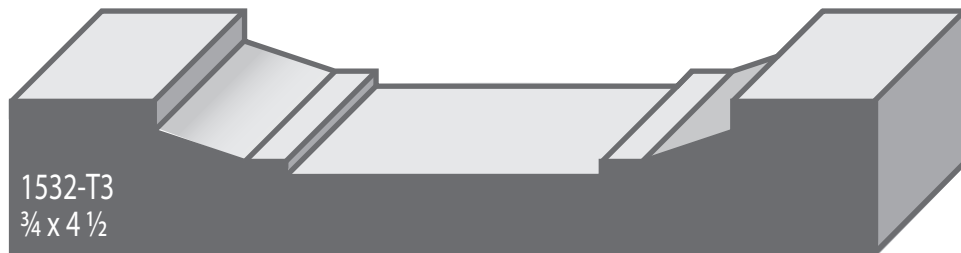
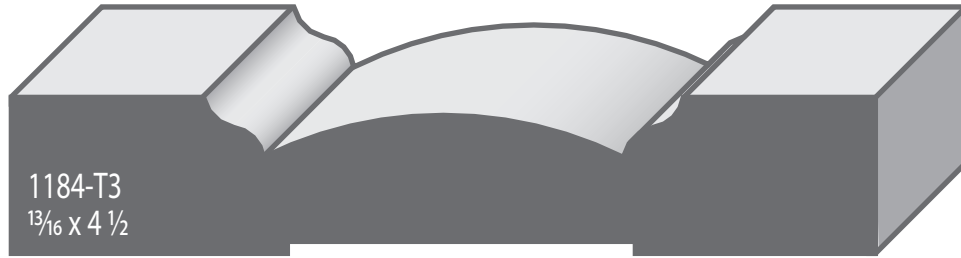
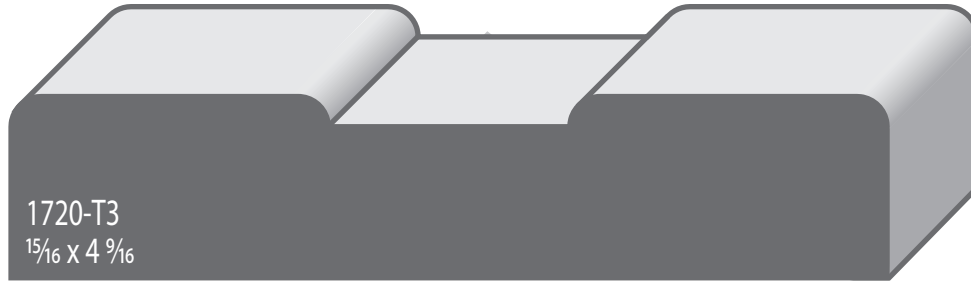

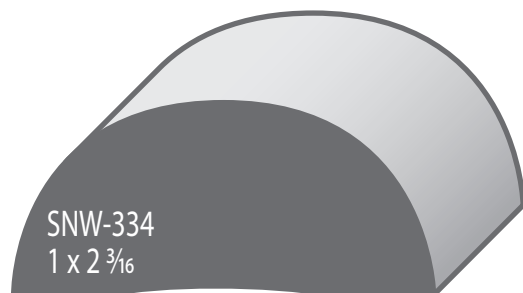
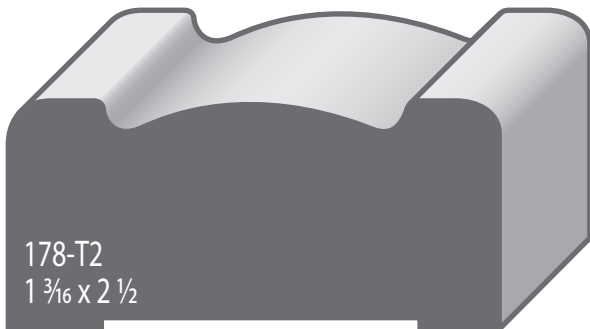
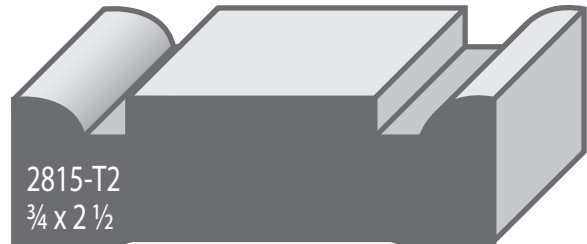
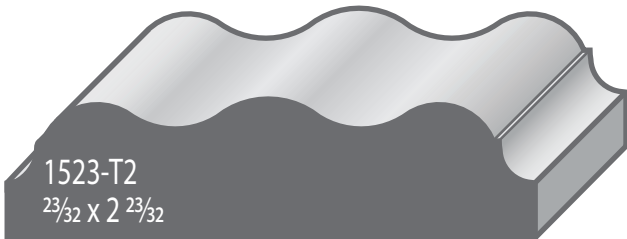
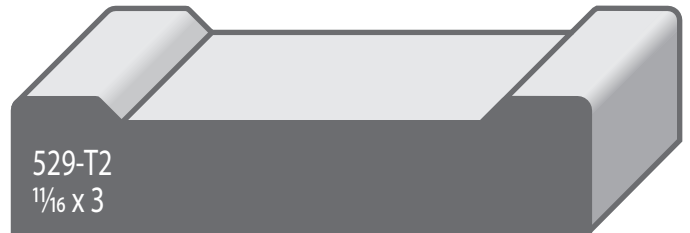
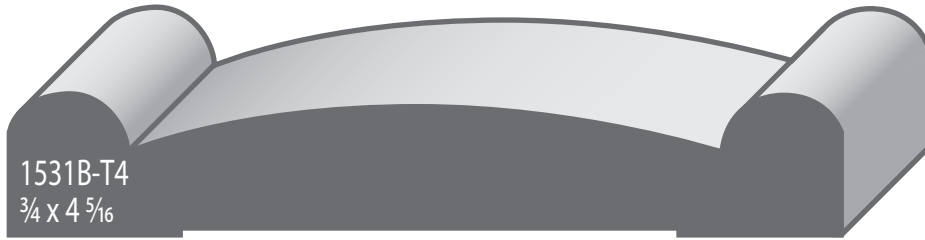

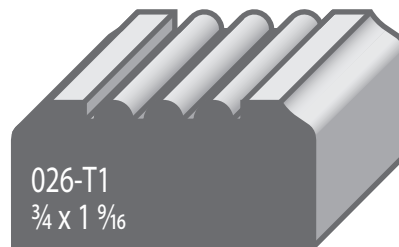
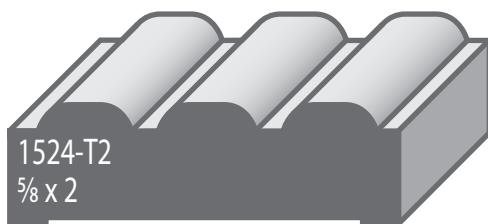
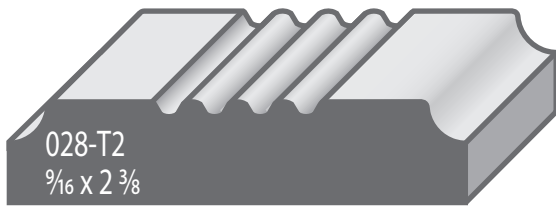
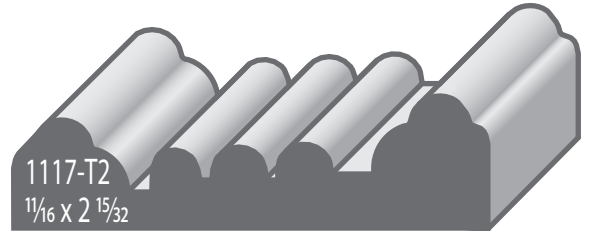
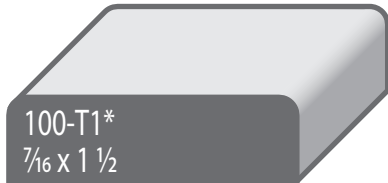
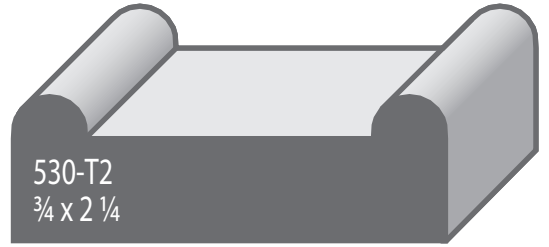

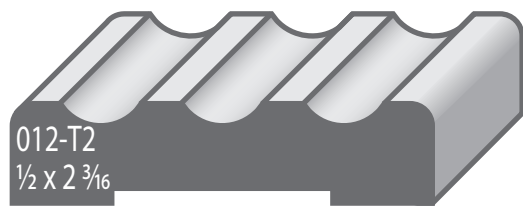
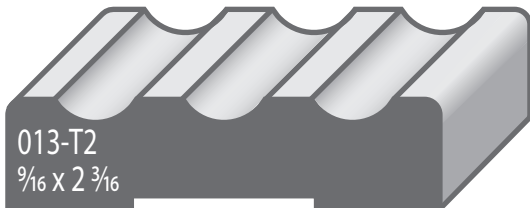
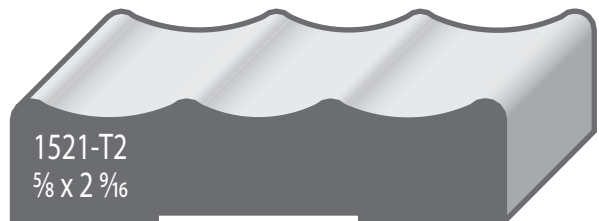
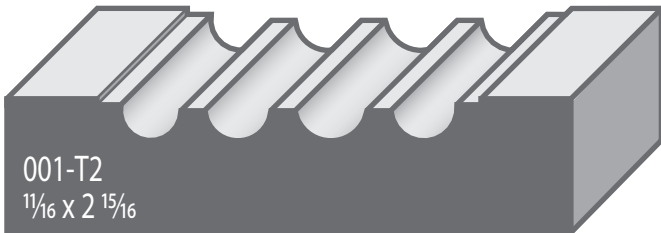
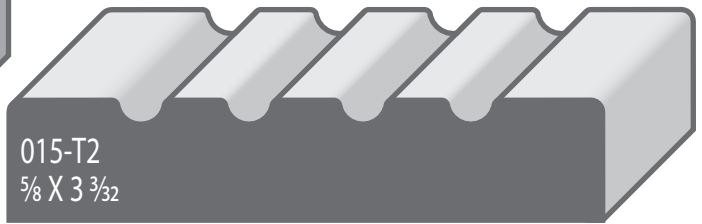
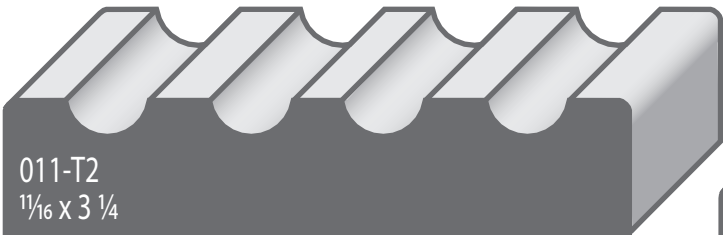
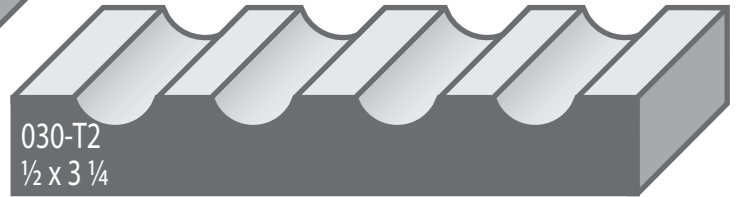
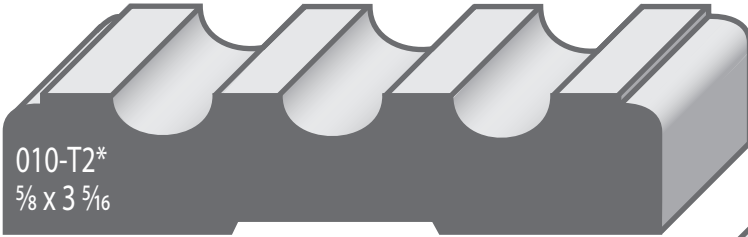
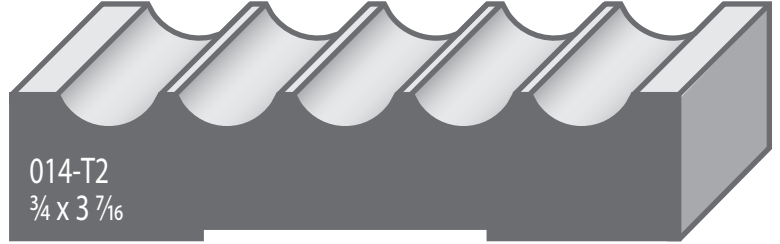
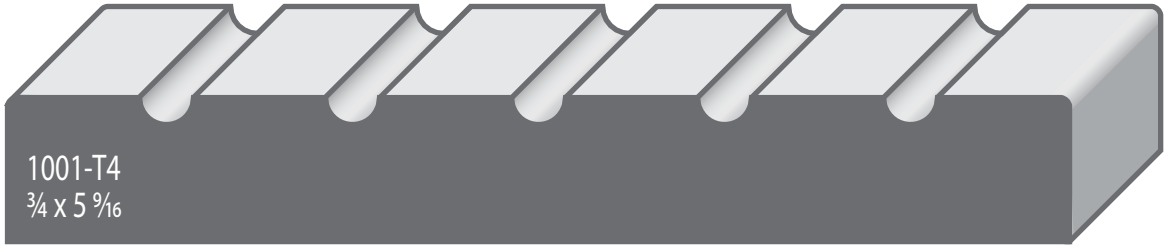

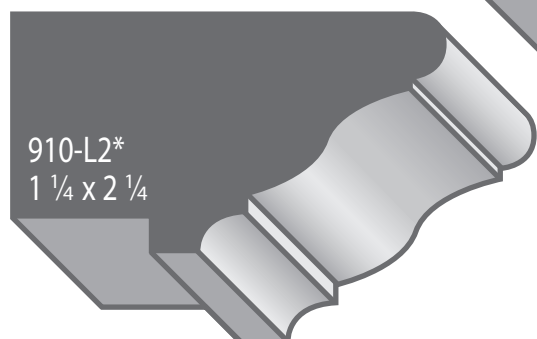
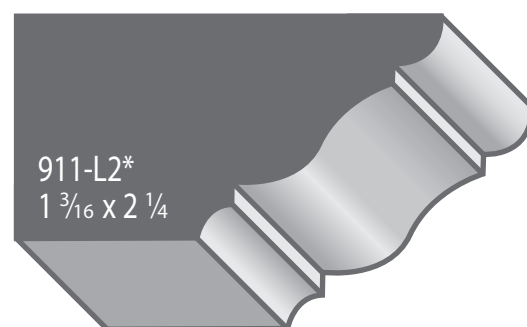
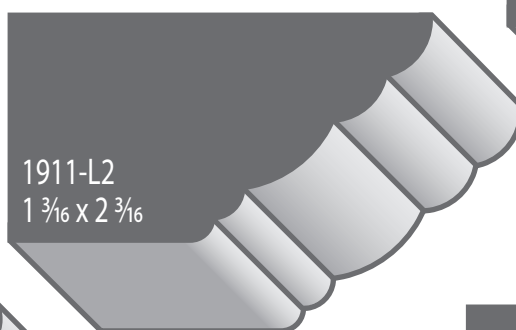
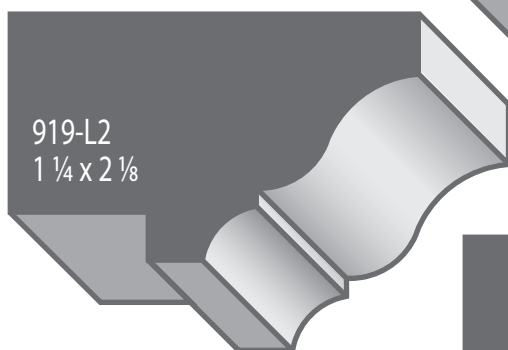
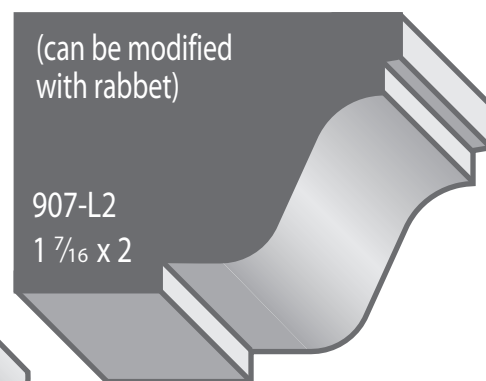
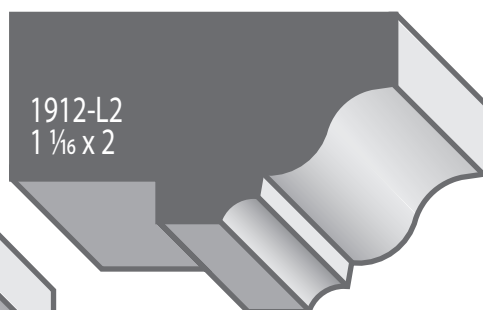
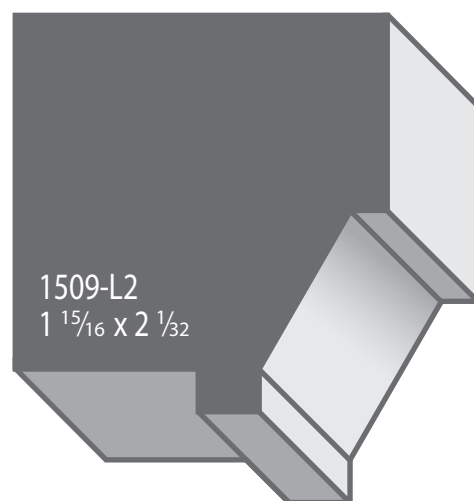
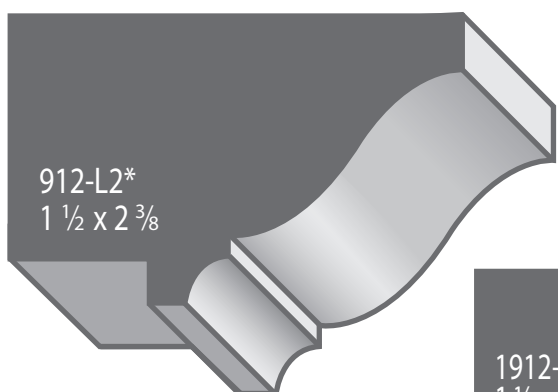
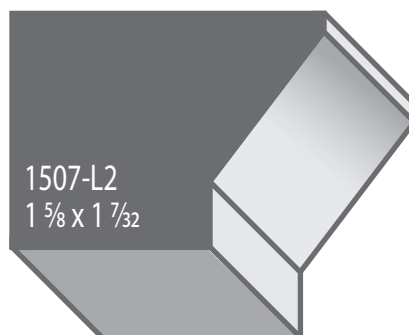
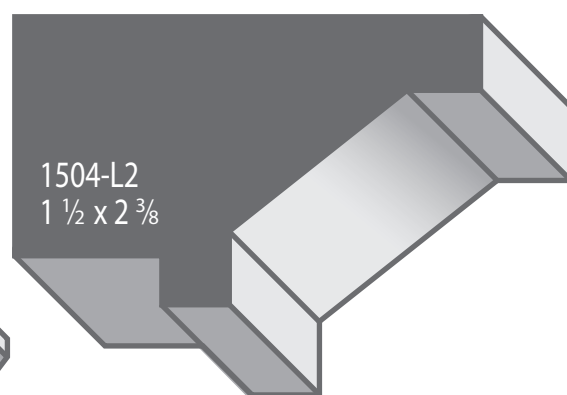
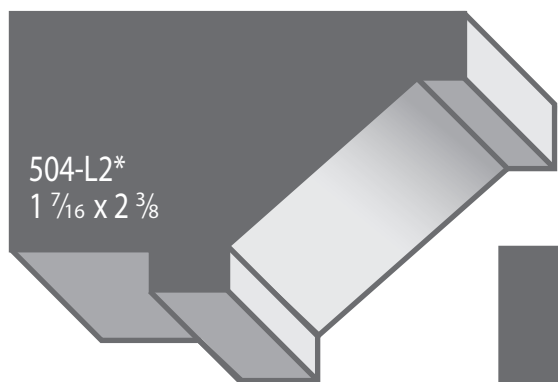

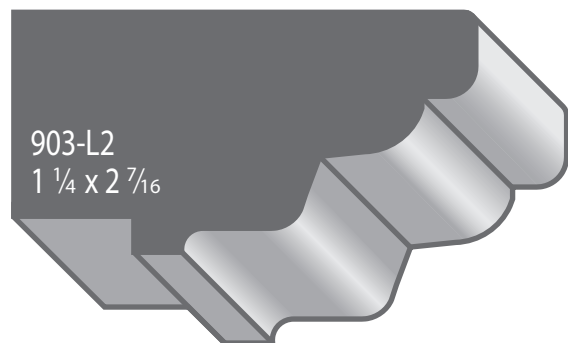
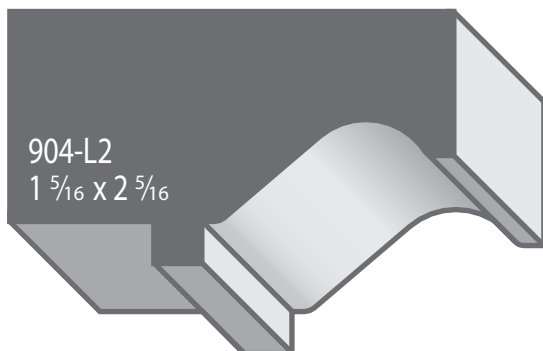
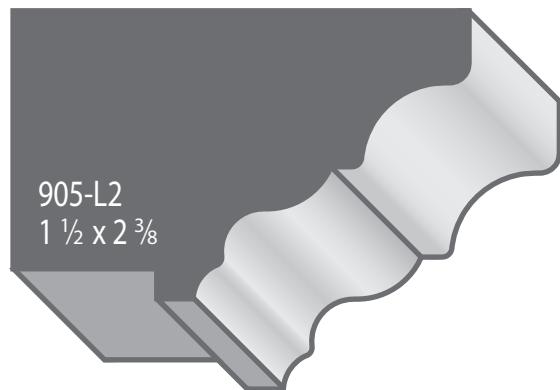
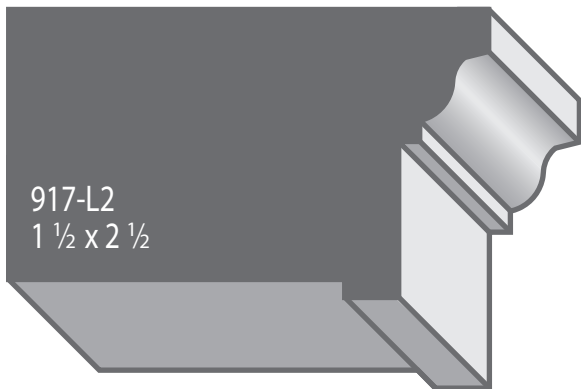
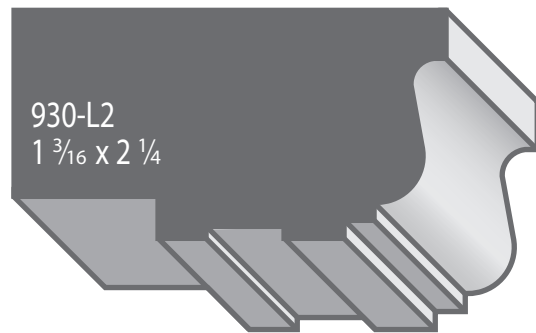
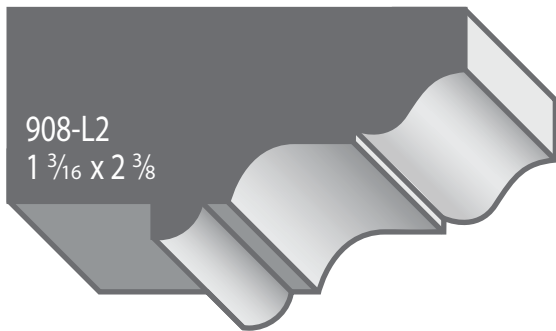
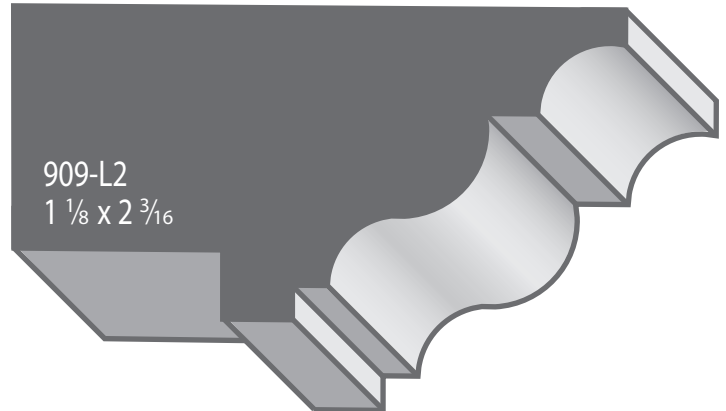
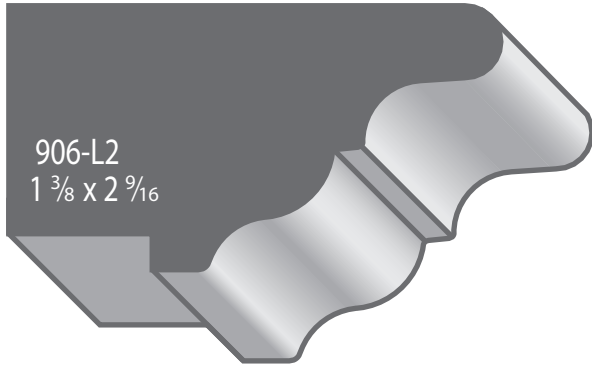
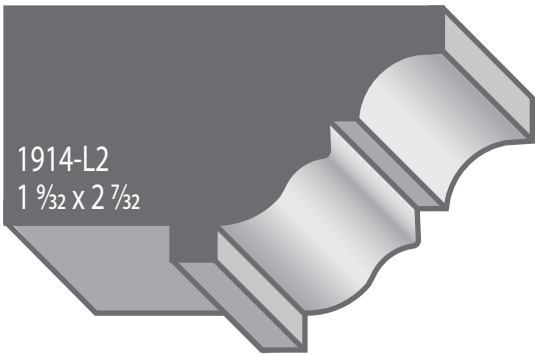

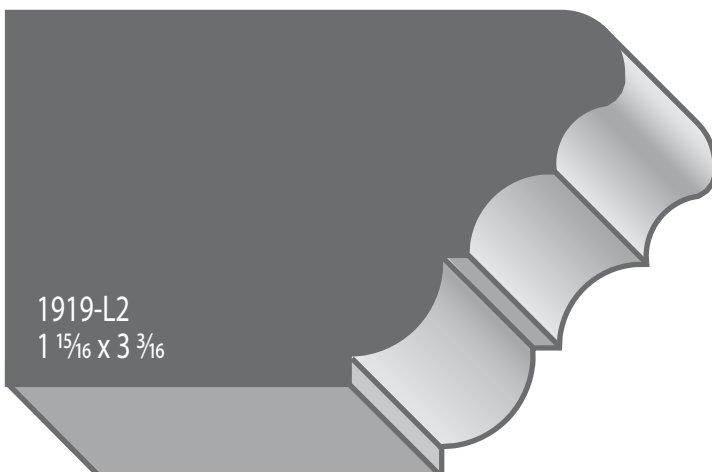
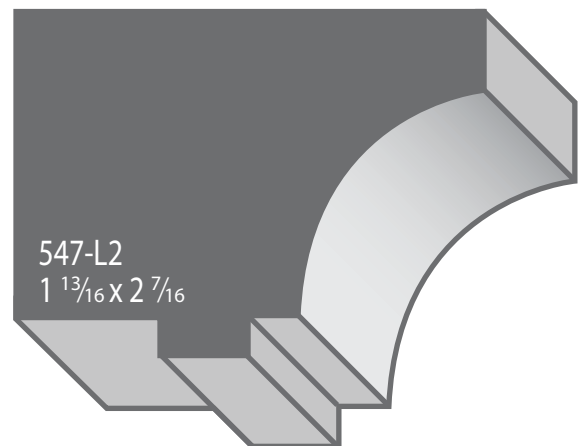
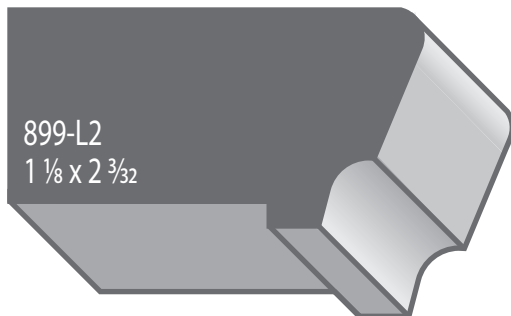
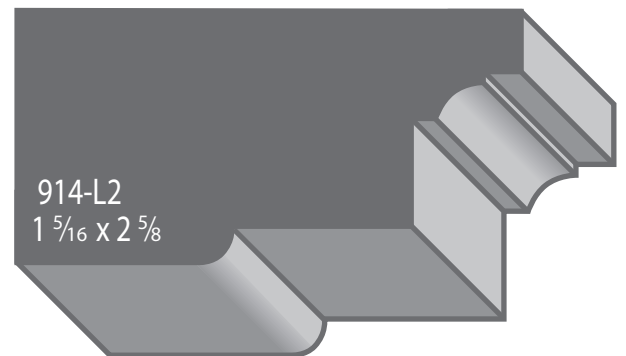
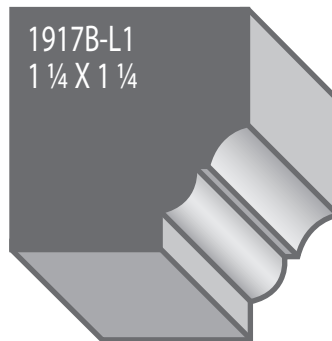
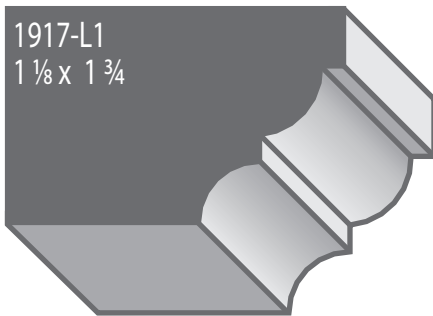
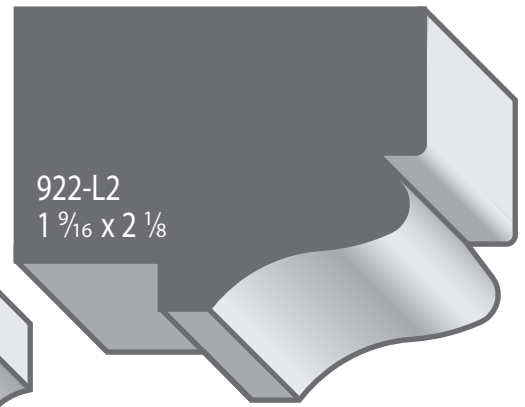
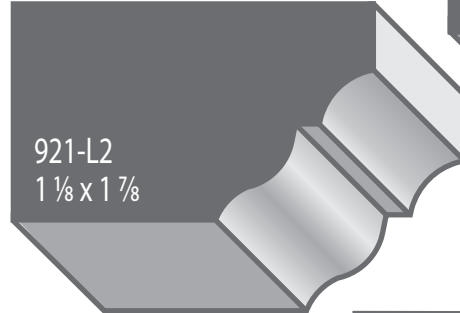
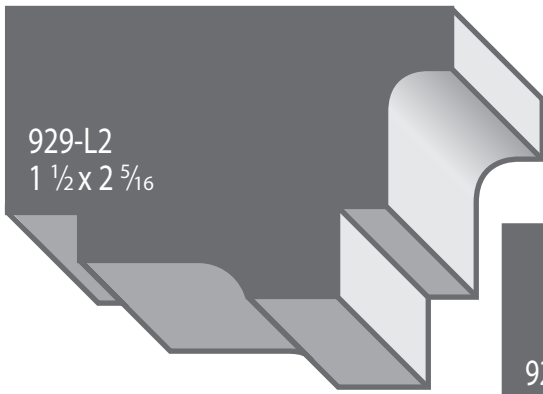

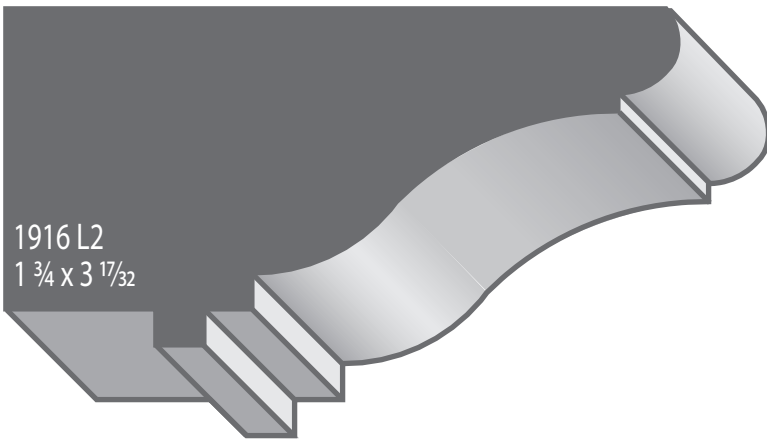

1916 L2
1 3/4 x 3 17/32

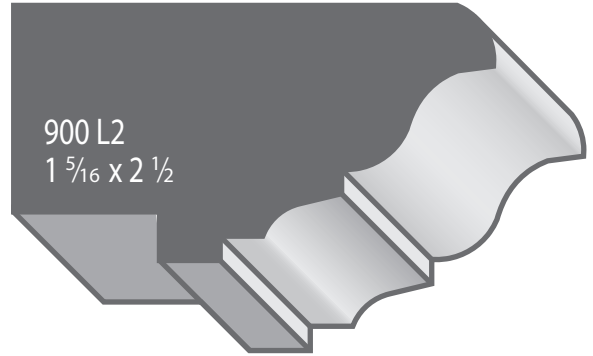

900 L2
1 5/16 x 2 1/2

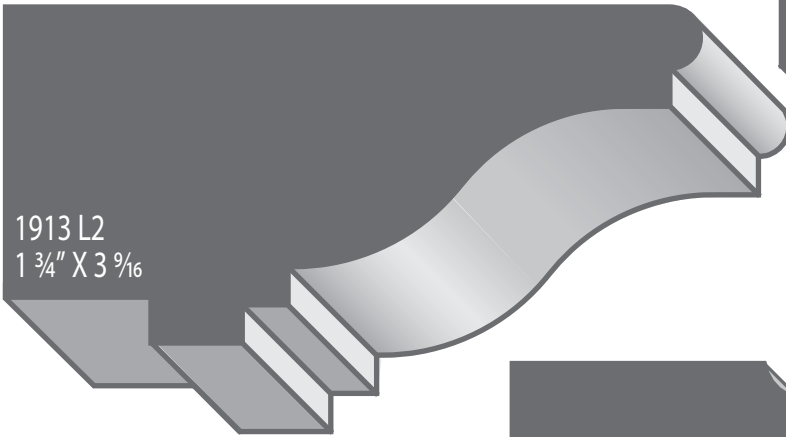

1913 L2
1 3/4" X 3 9/16

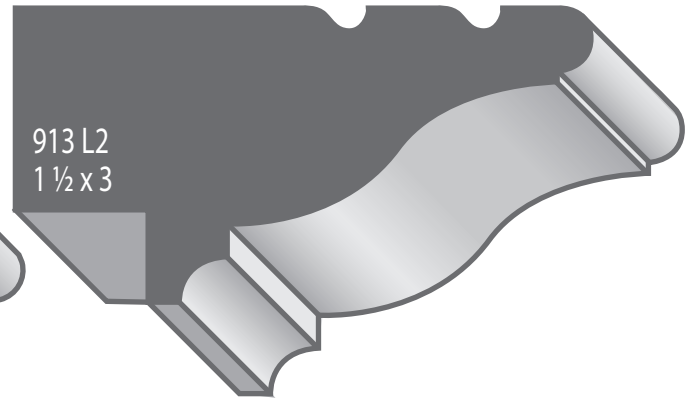

913 L2
1 1/2 x 3

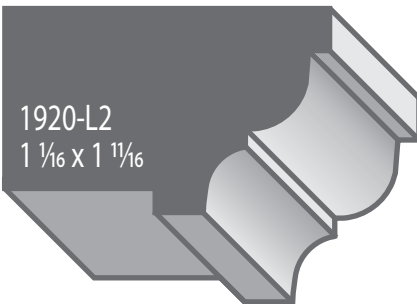

1920-L2
1 1/16 x 1 11/16

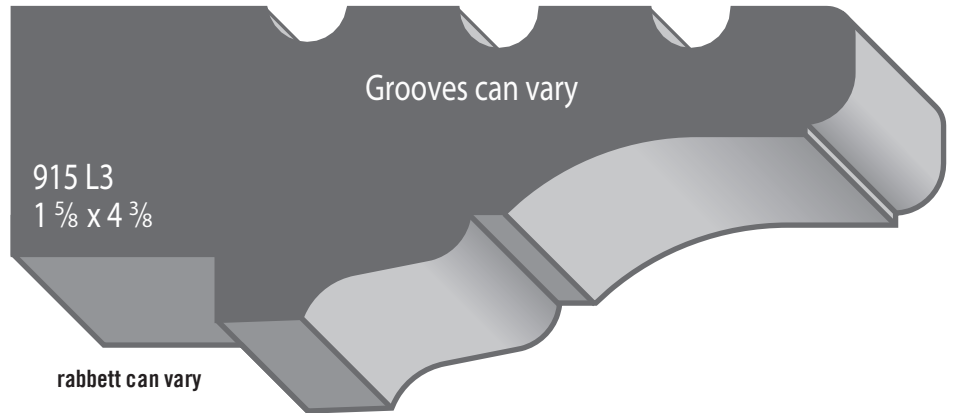

915 L3
1 5/8 x 4 3/8

Grooves can vary

rabbet can vary



948 S1
5/16 x 1 1/8



953 S1
3/8 x 1 5/8



949 S1
1/2 x 1 5/8



950 S1*
7/16 x 1 1/4



503 S1*
1/2 x 1 1/8



955 S1*
1/2 x 1 1/4



954 M1
1 1/16 x 1 1/2

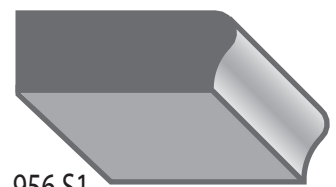

956 S1
3/8 x 1 1/8

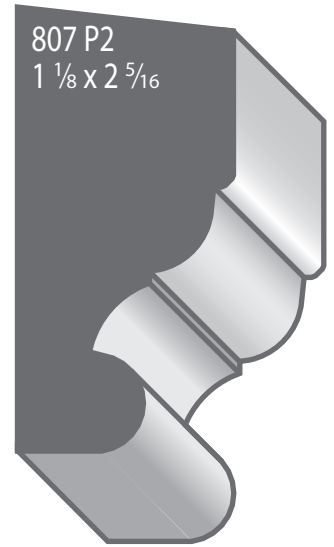

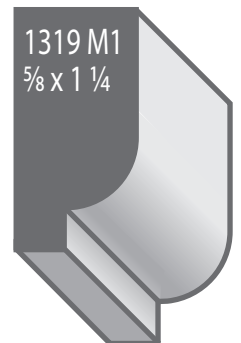
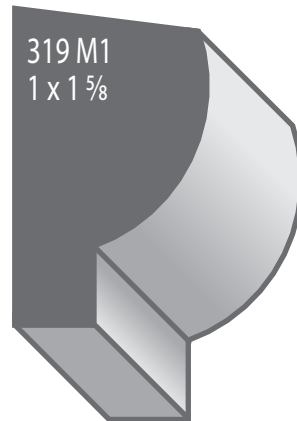
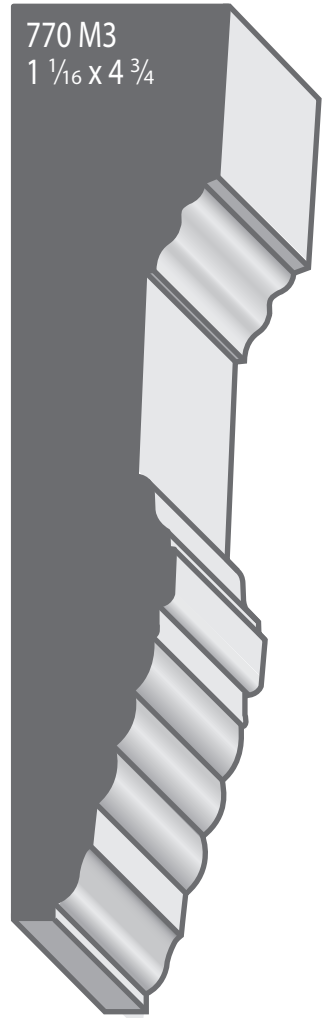
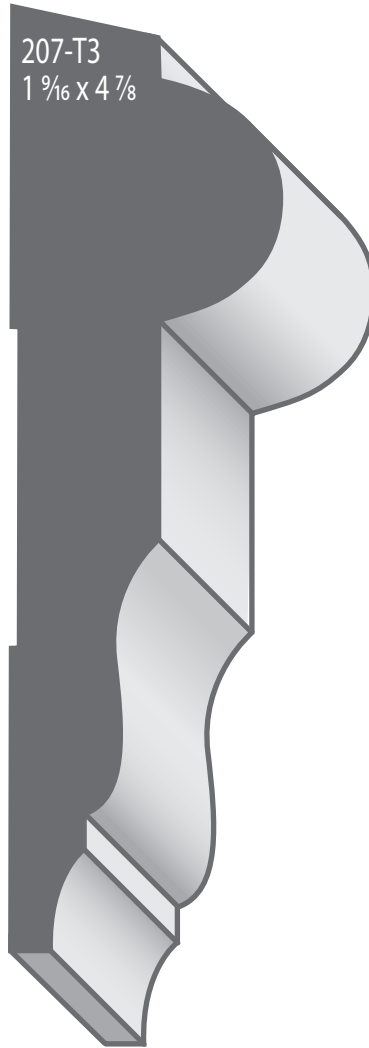
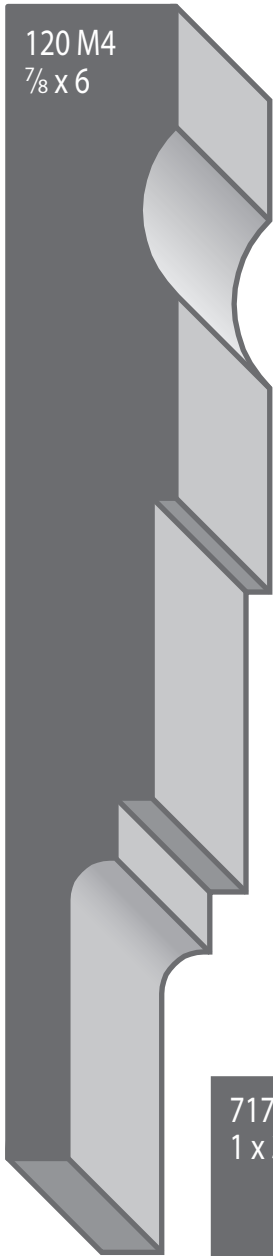

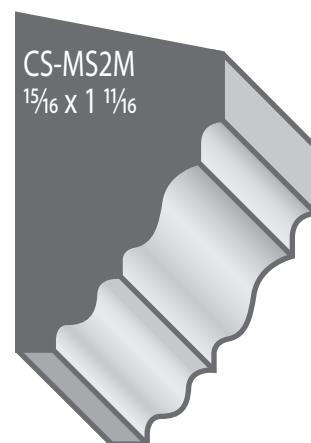
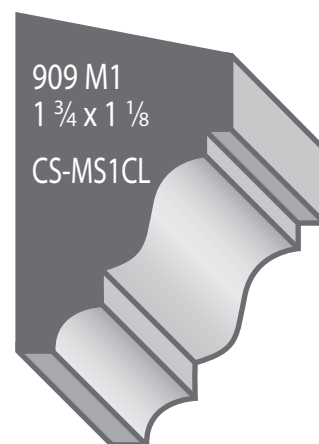
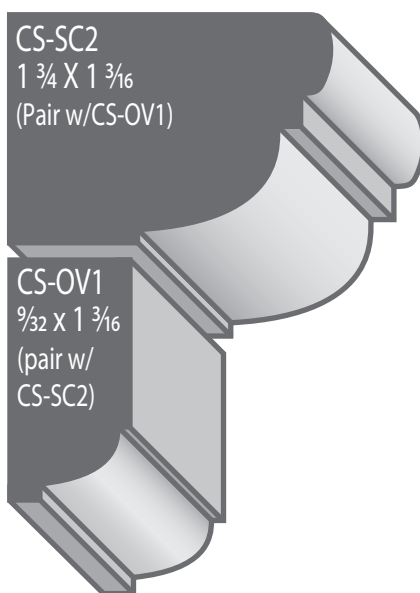
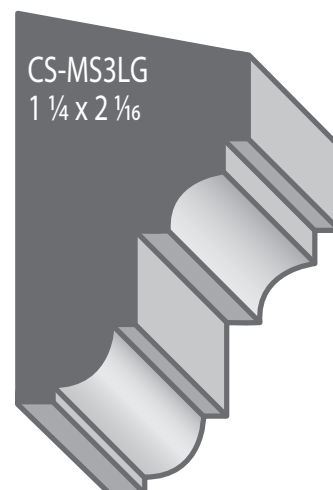
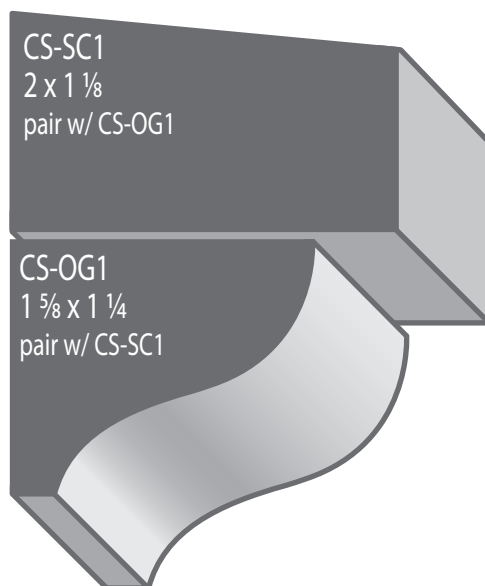
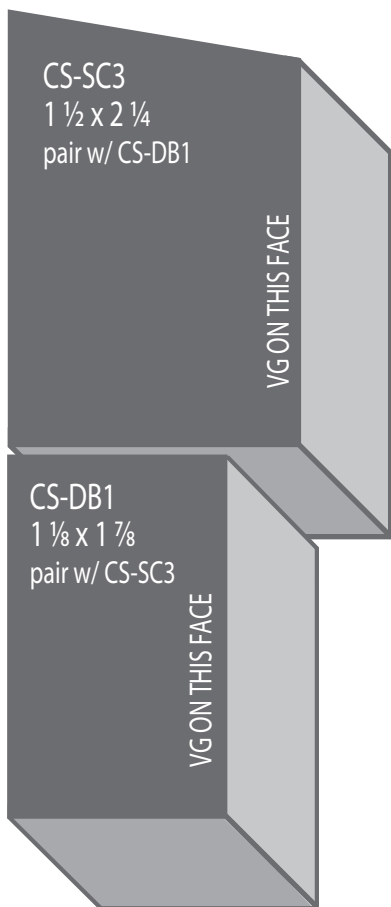

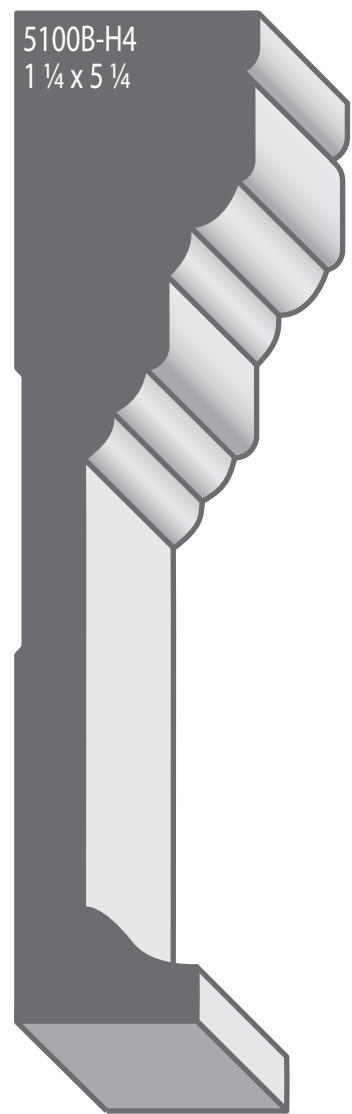
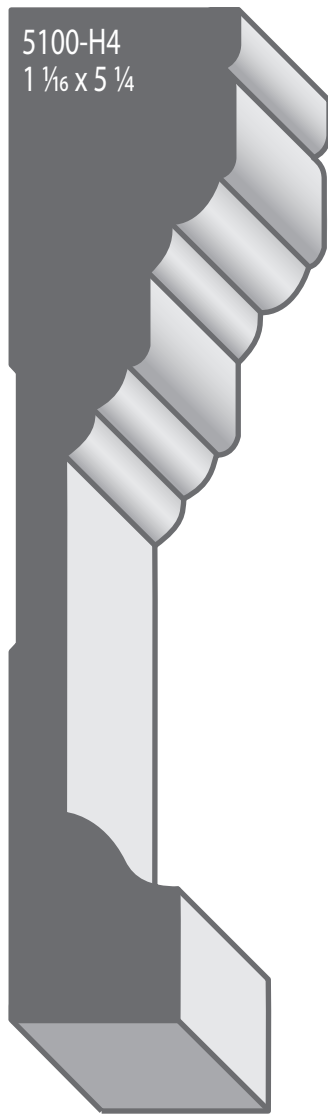

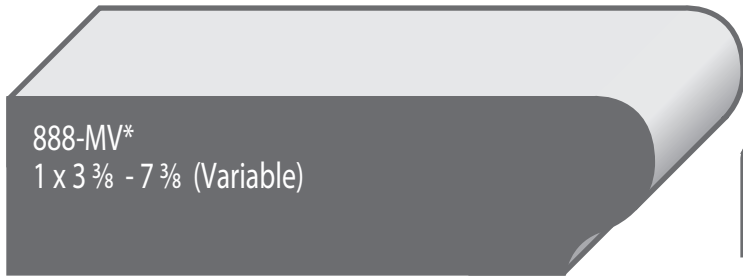

888-MV*
1 x 3 3/8 - 7 3/8 (Variable)



887-MV
1 7/16 x 3 (Variable)



889-MV
1 x 3 3/8 - 7 3/8 (Variable)

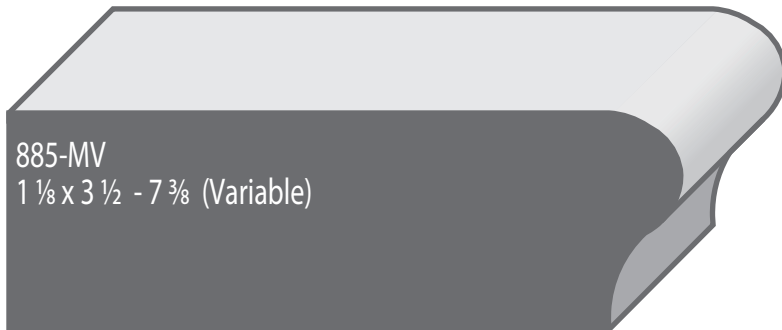

885-MV
1 1/8 x 3 1/2 - 7 3/8 (Variable)

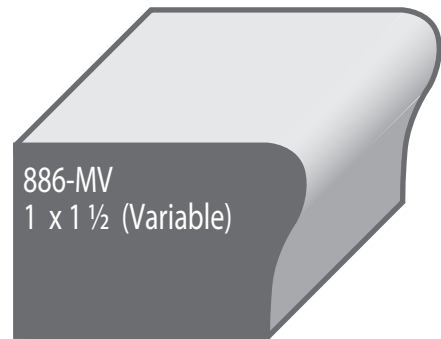

886-MV
1 x 1 1/2 (Variable)



422 S1
3/4 x 1 11/16

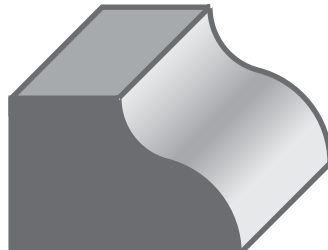

423 S1
13/16 x 1 3/16



409 S1
9/16 x 1 11/16

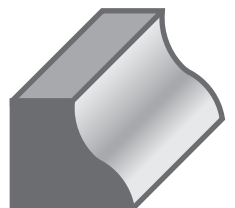

419 S1
9/16 x 5/8



415 S1
1/2 x 1 1/2

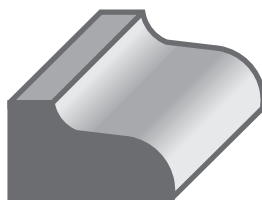

424 S1
1/2 x 7/8



1701-S1
1/2 x 1 25/32

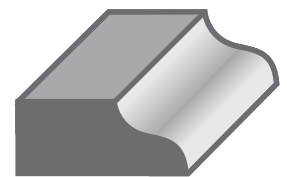

417 S1*
3/8 x 7/8



420 S1*
3/8 x 1 9/16



421-S1
3/8 x 1 11/16

