

Section B - Casings

McCOY MILLWORK

Custom Shop Services

For custom profiles pricing is determined by the chosen species of wood and quantity. Provide the following:

1. A sample or scale drawing of the profile.
2. Amount of moulding needed in Lineal Feet.
3. Preferred species of wood.
4. Preferred final finish (paint or stain).

Send us your information via email or come in for a quote. You can expect to hear from us regarding pricing in 2 days.

Manufacturing time varies: 2 days-2 weeks.

Profile #	Pg #	Profile #	Pg #	Profile #	Pg #	Profile #	Pg #
001-T2 Fluted Casing	62	130 T2* Casing	55	176 T2 Casing	46	387 MV Casing	48
010-T2* Fluted Casing	62	133 T2 Casing	55	177 T3 Casing	42	387 T2 Casing	47
011-T2 Fluted Casing	62	134 T2* Casing	48	178 T3 Symm Casing	60	388b T2 Casing	52
012 T2 Fluted Casing	62	138 T4 Casing	38	179 T3 Sym Casing	59	388c T2 Casing	52
013 T2 Fluted Casing	62	139 T2 Casing	50	180 T4* Sym Casing	57	388d T2 Casing	52
014 T2 Fluted Casing	62	140 T2* Casing	51	181b T4 Casing	57	388 T2 Casing	54
015 T2 Fluted Casing	62	141 T2 Casing	53	181 D4 Sym Casing	57	390 T2 Casing	45
021 T2 Reeded Casing	61	142 T2 Casing	52	181 T4 Sym Casing	58	391 T1 Casing	54
022 T2 Casing	50	143 T2 Casing	50	183 T3 Sym Casing	58	392.2 T2 Step Casing	48
023 T4 Sym Casing	57	144 T2 Casing	53	185b T2 Sym Casing	50	392 T2 Step Casing	48
024 T4 Sym Casing	58	145 T3 Casing	47	185 T2* Casing	47	409 S1 Stop	71
025 T2 Reeded Casing	61	148 T2 Casing	43	187 D2 Symm Casing	61	410 T2 Casing	52
026 T1 Reeded Casing	61	149b T2 Casing	47	191 T2 Casing	52	411 T2* Casing	49
027 T2 Reeded Casing	61	149 T2 Casing	44	193 T2 Casing	52	413 T2 Casing	49
028 T2 Sym Casing	61	150 T2* Casing	49	194 T2 Casing	51	415 S1 Stop	71
029 T2 Symmetrical Casing	60	151 T3 Casing	39	196 T2 Casing	50	416 T3 Casing	39
030 T2 Fluted Casing	62	152 T3 Casing	39	248 P2 Casing	54	417 S1* Stop	71
031-T3 Symm Casing	60	153 M2 Apron	67	261 T1 Clamshell Casing	56	419 S1 Stop	71
100 T1* Sym Casing	61	153 T3 Casing	38	262 T1* Clamshell Casing	56	420 S1* Stop	71
107 T1 Casing	55	155 T3* Casing	41	263 T1 Clamshell Casing	56	422 S1 Stop	71
108 T1 Casing	55	156 T2 Casing	43	263 T2 Clamshell Casing	56	423 S1 Stop	71
109 T1 Casing	55	158 T2 Casing	43	264b T2 Casing	52	424 P2 Misc/Apron	67
110 T1* Casing	55	158 T4 Casing	38	264 T2 Casing	50	424 S1 Stop	71
111b T2 Casing	46	159 T3 Casing	41	265 T2* Clamshell Casing	56	427 P2 Apron	67
111 T2* Casing	48	162 B2 Casing	54	266 T2 Casing	50	436 P1 Apron	68
112 T1* Casing	54	170b T2 Casing	51	268 T2 Clamshell Casing	56	444 T2* Casing	49
113 T2* Casing	49	170c T2 Casing	51	269 M2 Apron	67	447 T2 Casing	48
114 BV Casing	37	170 T2 Casing	52	304 A2 Backband	72	448 T2 Casing	45
115 T2* Casing	53	171b T2 Casing	52	319 M1 Apron	68	487 T2 Casing	49
116 T2 Casing	45	171 T2 Casing	50	355 T2 Casing	50	488 T2 Casing	48
117 T2 Casing	50	172 T2 Casing	49	356 T2* Casing	53	496 T3 Casing	39
118 T2 Casing	49	173b T2 Casing	44	357 T2 Casing	54	503 S1* Parting Bead	66
119 T3 Casing	41	173 T2 Casing	46	358 T2 Casing	54	504 L2* Lintel	63
120 M4 Apron	68	174b T2 Casing	48	359 T2 Casing	51	528 PV Apron	67
120 T2 Casing	48	174 T2 Casing	46	384 BV Apron	68	529 T2 Sym Casing	61
121 T2 Casing	47	175 T2 Casing	49	386 T3 Casing	39	530 T2 Symm Casing	61



Profile #	Pg #	Profile #	Pg #	Profile #	Pg #	Profile #	Pg #
533 T2 Casing	46	913 L2 Lintel	66	1126 A1 Backband	72	1212 T4 Casing	37
534 T2 Casing	47	914 L2 Lintel	65	1127 A1 Backband	72	1213 T3 Casing	40
534-T3 Casing	40	915 L3 Lintel	66	1128 A1 Backband	72	1214 T4 Casing	37
535 T2* Casing	46	916 L2 Lintel	65	1129 A1 Backband	72	1261 T1 Clamshell Casing	56
536 T3 Casing	40	917 L2 Lintel	64	1130 T2 Casing	55	1262 T1 Clamshell Casing	56
547 L2 Lintel	65	919 L2 Lintel	63	1131 T1 Casing	55	1264 T2 Clamshell Casing	56
620 T2 Casing	51	921 L2 Lintel	65	1132 T2 Sanitary Casing	55	1266 T2 Casing	53
717 D2 Apron	68	922 L2 Lintel	65	1133 T2 San Casing	55	1316 T3 Casing	39
726 P2 Apron	67	929 L2 Lintel	65	1137 T4 Casing	38	1318 A2 Backband	71
746 P2 Apron	67	930 L2 Lintel	64	1138 T3 Casing	39	1319 M1 Apron	68
750 T2 Casing	49	931 M2 Apron	67	1139 T2 Casing	43	1381 T3 Casing	42
751 MV Apron	67	948 S1 Bead	66	1139 T3 Casing	38	1438 T2 Colonial Casing	47
753 D4 Architrave	69	949 S1 Bead	66	1139 TV Casing	45	1439 T2 Colonial Casing	46
755 T2 Casing	49	950 S1* Parting Bead	66	1140 T2 Casing	53	1444 T3 Casing	40
756 T2 Casing	42	953B-S1 Parting Bead	66	1141 T2 Casing	54	1460 T2 Casing	53
757 T4 Casing	37	953 S1 Bead	66	1142 T2 Casing	51	1461 T2 Casing	48
770 M3 Apron	68	954 M1 Bead	66	1143 T2 Casing	51	1462 T2 Casing	48
772 M4 Apron	68	955 S1* Parting Bead	66	1145 T2 Casing	50	1463 T2 Casing	47
781 P2 Casing	51	956 S1 Parting Bead	66	1146 T2 Casing	51	1464 T2 Apron/Misc	67
782 A1 Backband	71	984 A1 Backband	72	1148 T2 Casing	51	1467 T2 Casing	47
803 T2 Symm Casing	61	985 A1 Backband	72	1149 T2 Casing	50	1504 L2 Lintel	63
804 T3 Sym Casing	59	990 A1 Backband	71	1150 T2 Casing	44	1507 L2 Lintel	63
806 T2 Casing	50	1001 T4 Fluted Casing	62	1151 T2 Casing	42	1509 L2 Lintel	63
807 P2 Apron	67	1020 A1 Backband	72	1152 T2 Casing	44	1521 T2 Sym Casing	62
808 T2 Casing	53	1021 A1* Backband	72	1153 T2 Casing	44	1523 T2 Sym Casing	61
821 T2 Casing	44	1022 A1* Backband	72	1154 T2 Casing	43	1526 T2 Symm Casing	61
885 MV Sill	70	1024 A1 Backband	72	1156 T2 Casing	46	1527 T3 Sym Casing	60
886 MV Sill	70	1025 A1* Backband	72	1157 T2 Casing	44	1528 T4 Sym Casing	60
887 MV Sill	70	1026 A1 Backband	71	1158 T2 Casing	43	1529 T4 Sym Casing	60
888 MV* Sill	70	1027 A1 Backband	72	1159 T2 Casing	45	1530 T2 Casing	43
889 MV Sill	70	1028 P2 Backband	72	1170 T2 Casing	52	1531 T4 Sym Casing	58
894 D2 Sym Casing	61	1029 A1* Backband	72	1171 T2 Casing	47	1532 T3 Sym Casing	59
899 L2 Lintel	65	1039 T2 Casing	53	1172 T2 Casing	51	1560 T3 Casing	41
900 L2 Lintel	66	1104 T2 Casing	53	1173 T2 Casing	48	1561 T2 Casing	43
901 L2 Backband	71	1105 T2 Casing	53	1174 T2 Casing	51	1570 T3 Sym Casing	59
902 L2 Lintel	64	1111B-T2 Casing	45	1175 T2 Casing	50	1720 T3 Symm Casing	60
903 L2 Lintel	64	1111-T2 Casing	44	1176 T2 Casing	46	1804 T2 Casing	54
904 L2 Lintel	64	1113-T2 Casing	47	1177 T2 Casing	46	1911 L2 Lintel	63
905 L2 Lintel	64	1114 T3 Casing	42	1181 T4 Sym Casing	57	1912 L2 Lintel	63
906 L2 Lintel	64	1117 T2 Reeded Casing	61	1182 T4 Sym Casing	57	1913 L2 Lintel	66
907 L2 Lintel	63	1118 T2 Casing	53	1183 T3 Sym Casing	59	1914 L2 Lintel	64
908 L2 Lintel	64	1120 T2 Casing	52	1183 T4 Sym Casing	58	1916 L2 Lintel	66
909 L2 Lintel	64	1121 T2 Casing	47	1184 T3 Sym Casing	59	1917 L1 Lintel	65
909 M1 Apron	67	1122 T2 Casing	49	1188 T4 Sym Casing	57	1919 L2 Lintel	65
910 L2* Lintel	63	1123 A1 Backband	72	1193 T2 Casing	51	1920 L2 Lintel	65
911 L2* Lintel	63	1124 T2 Casing	44	1203 T2 Casing	54	1922 A1 Backband	72
912 L2* Lintel	63	1125 A1 Backband	71	1211 T4 Casing	37	3120 T2 Casing	42



Profile #	Pg #	Profile #	Pg #	Profile #	Pg #	Profile #	Pg #
3121 T3	Casing 40						
3122 T2*	Casing 45						
3133 T2	Casing 45						
3134B-T4	Casing 37						
3134 T4	Casing 41						
3135 T3	Casing 40						
3136 T4	Casing 38						
3137 T4	Casing 42						
3138 T3	Casing 41						

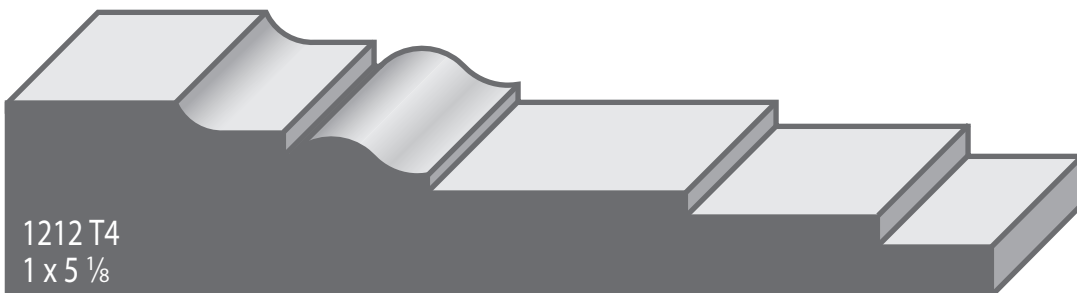
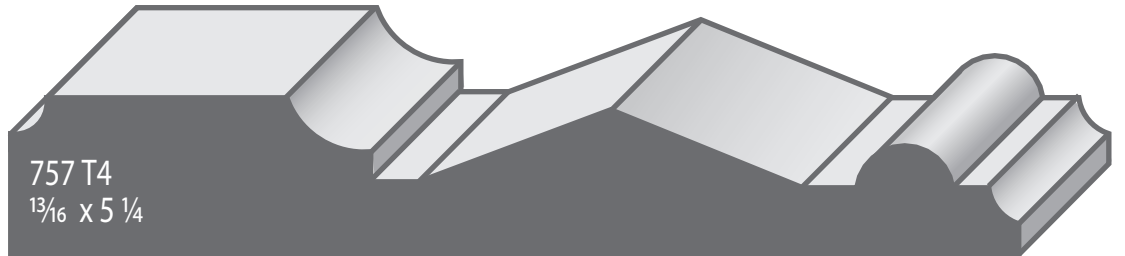
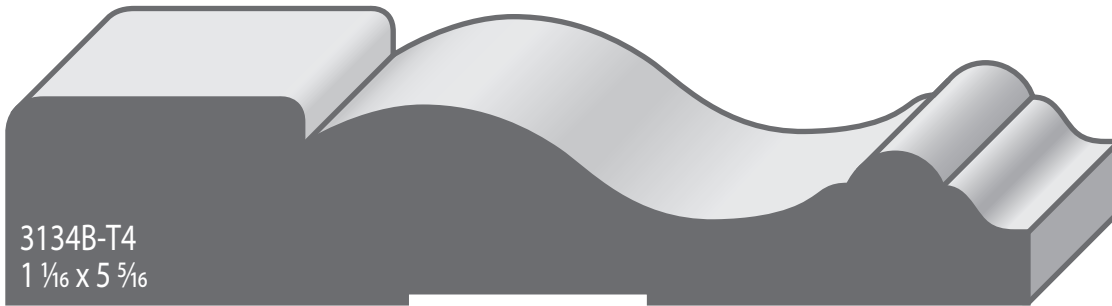
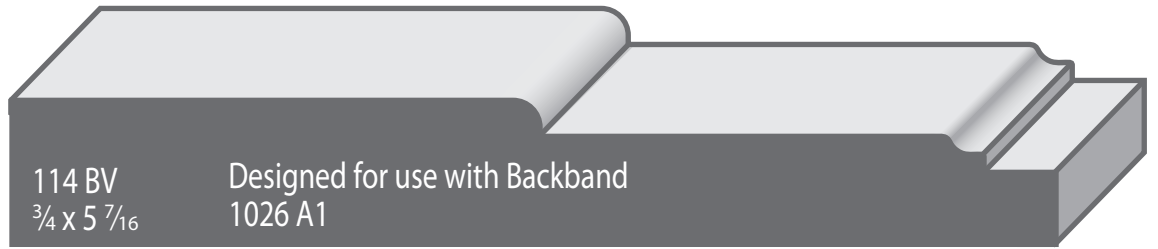
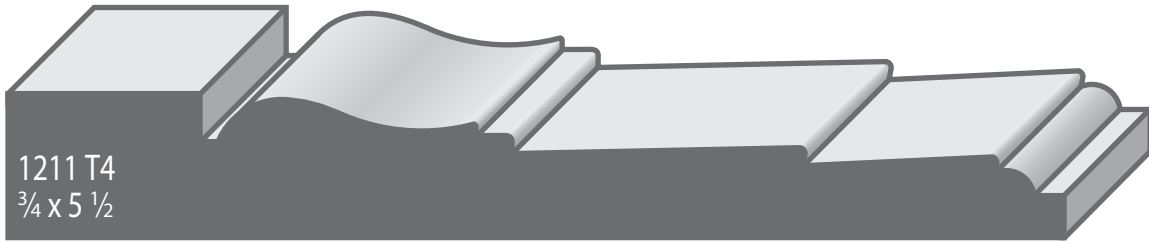
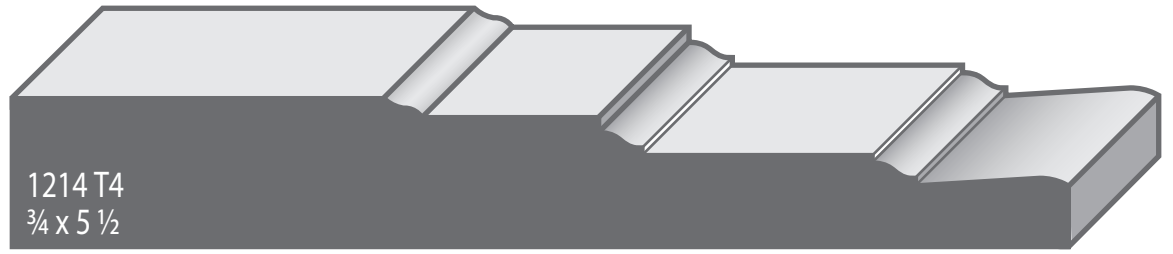

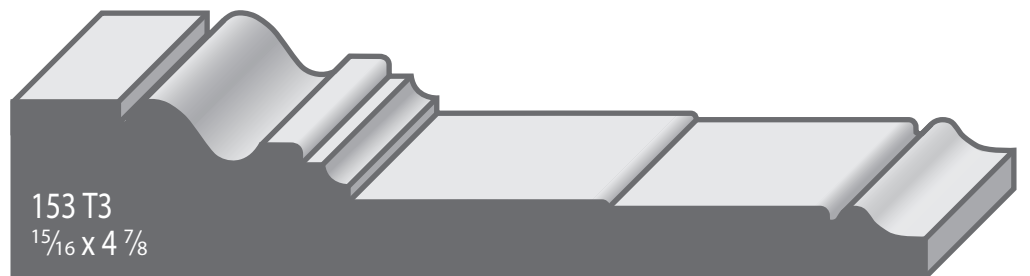
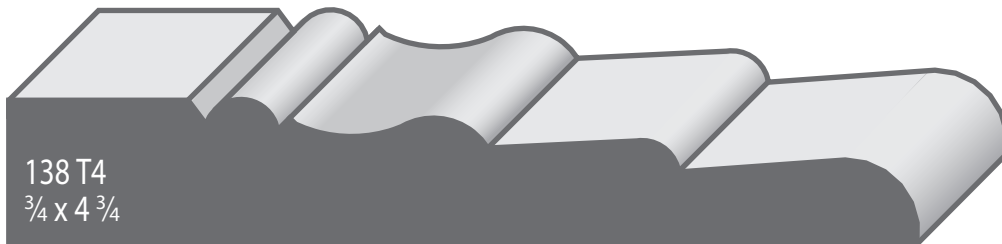
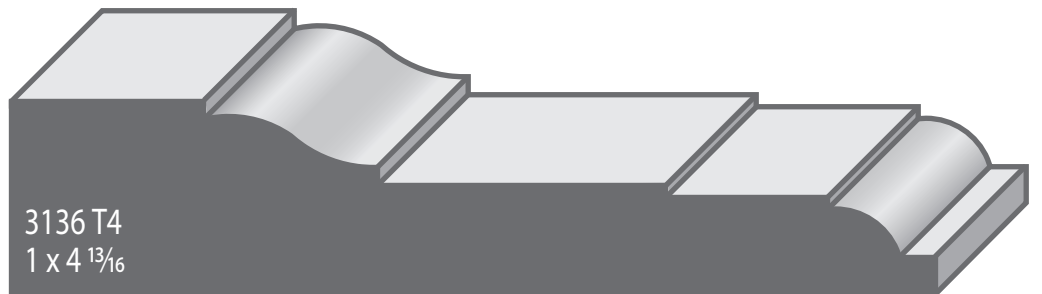
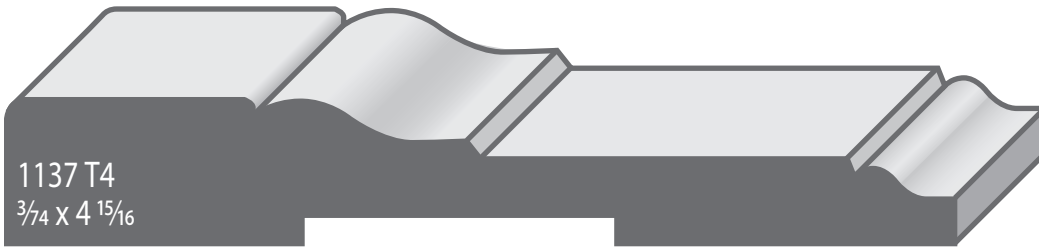
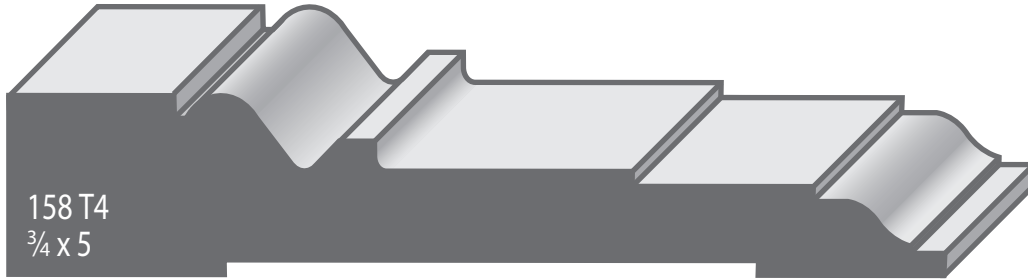

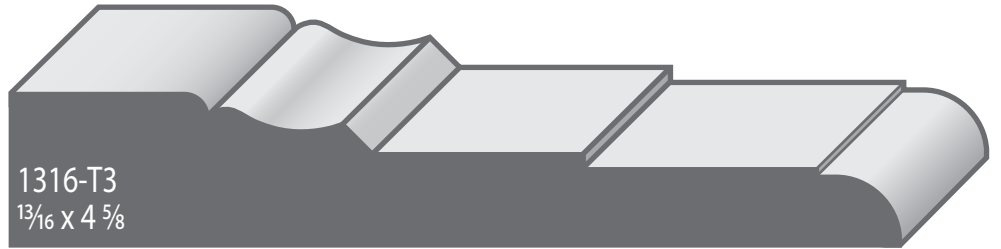
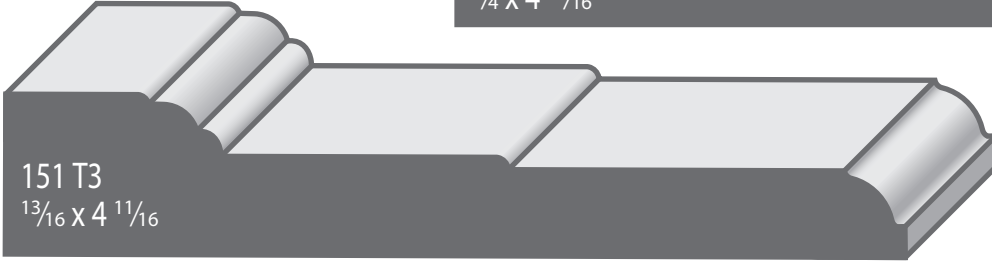
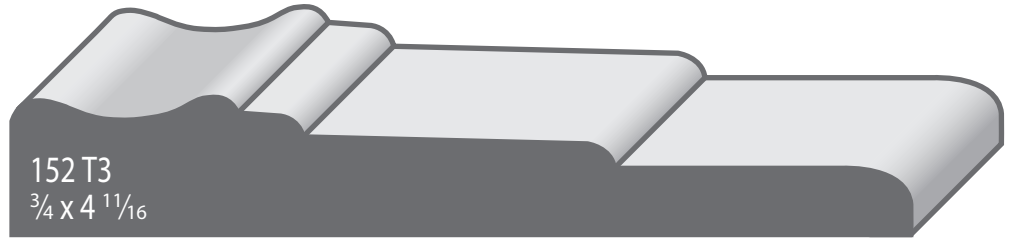

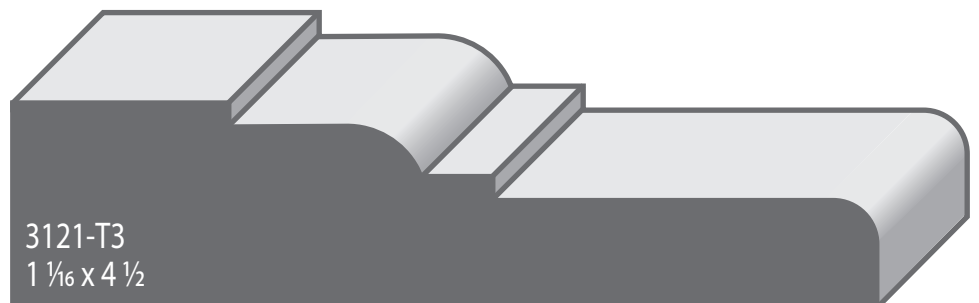
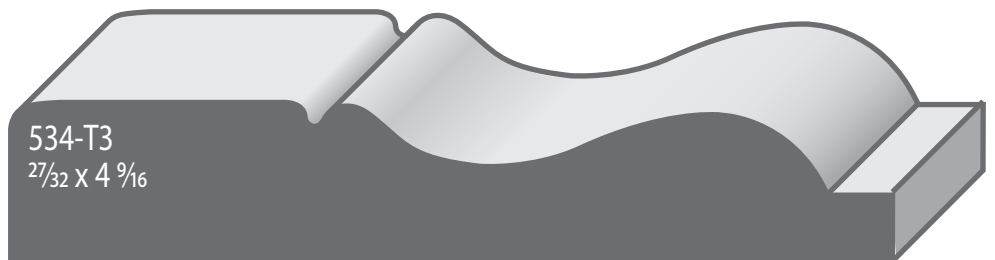
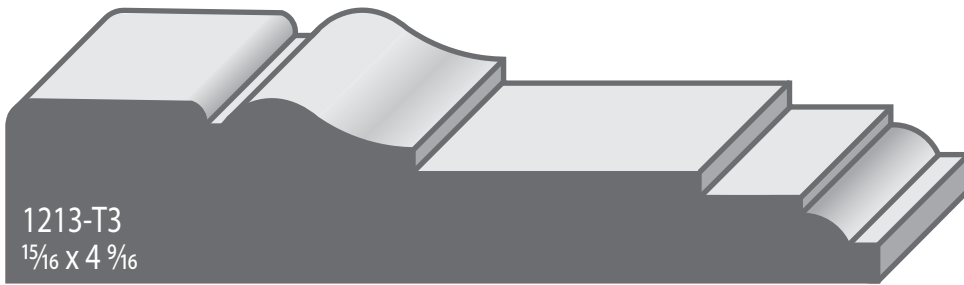
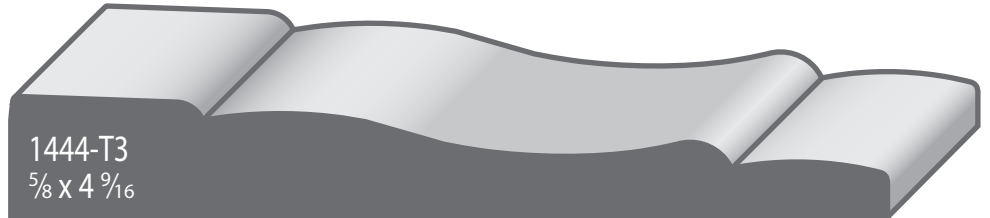
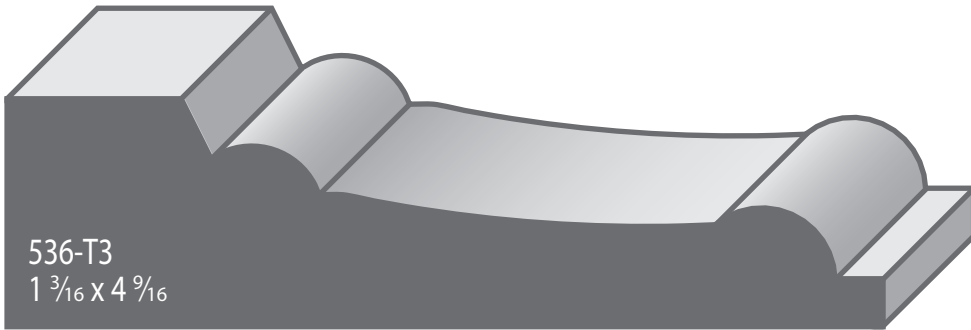

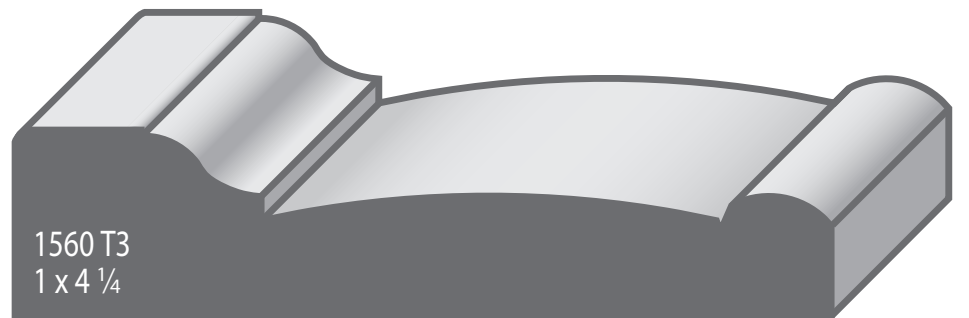
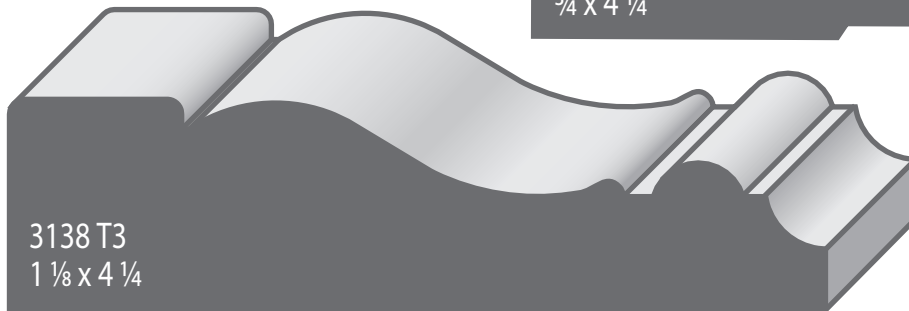
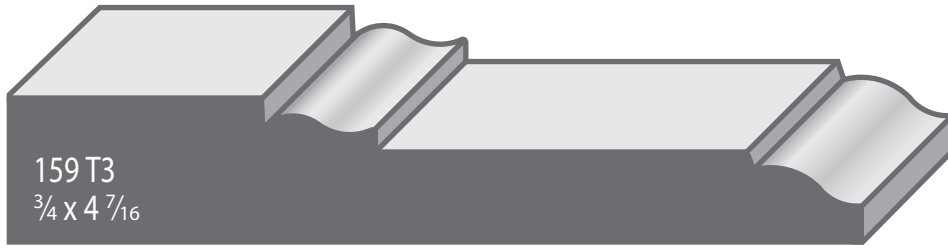
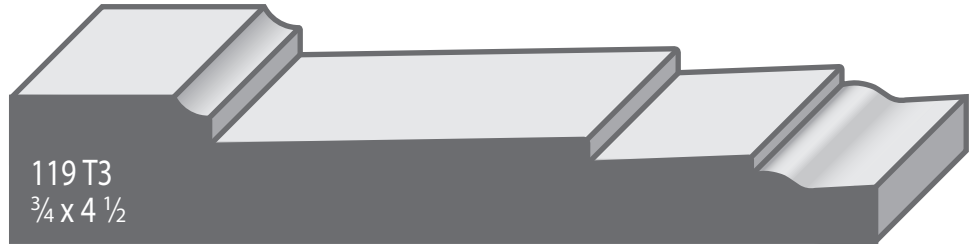

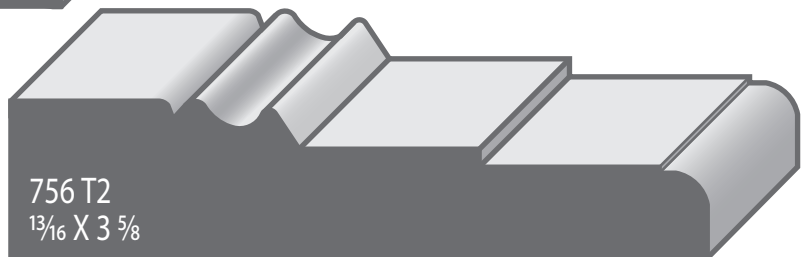
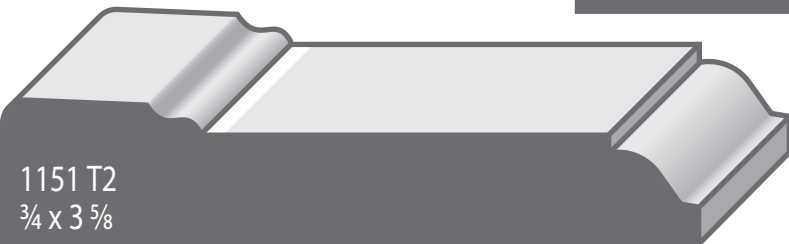
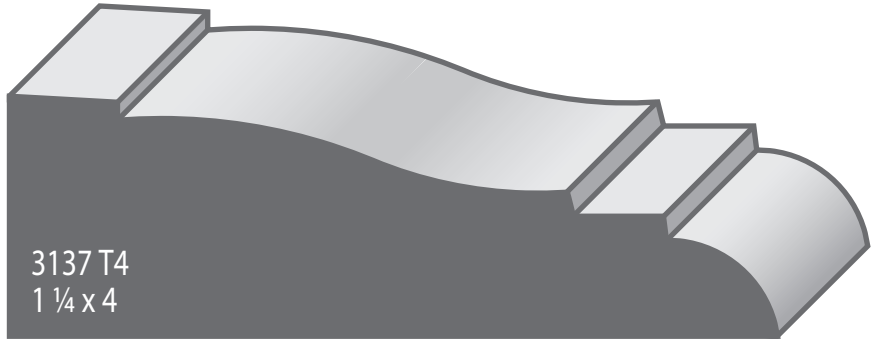
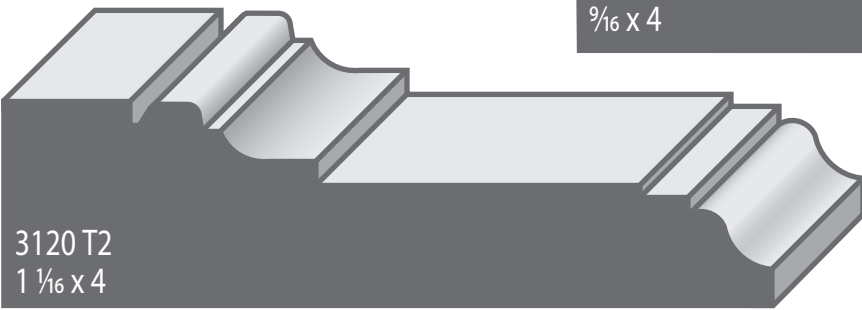
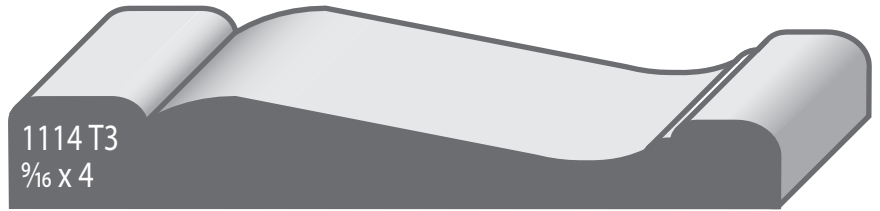
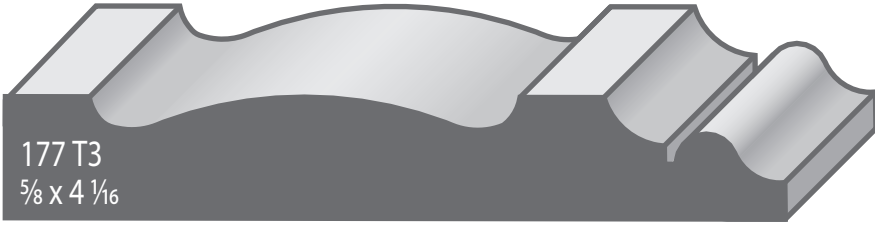

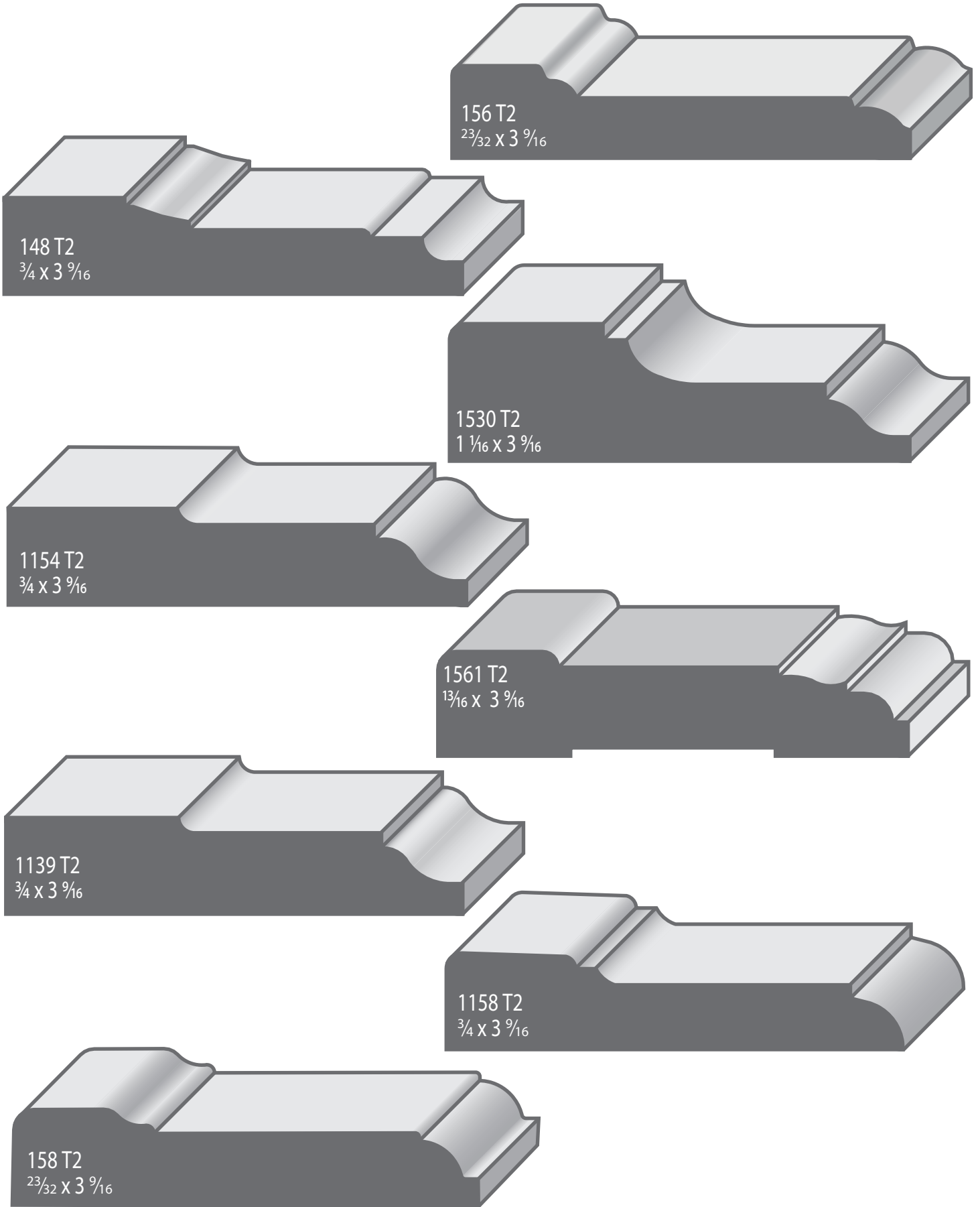

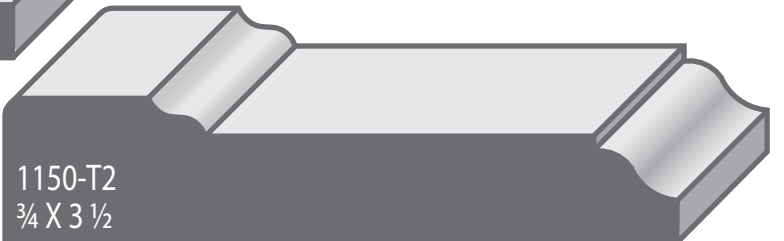
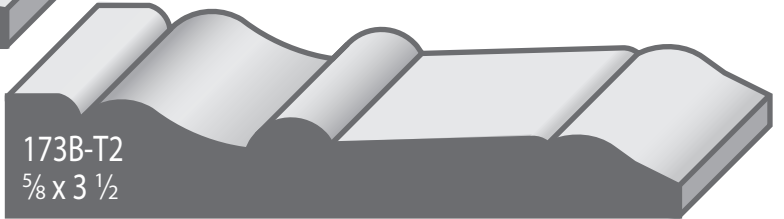
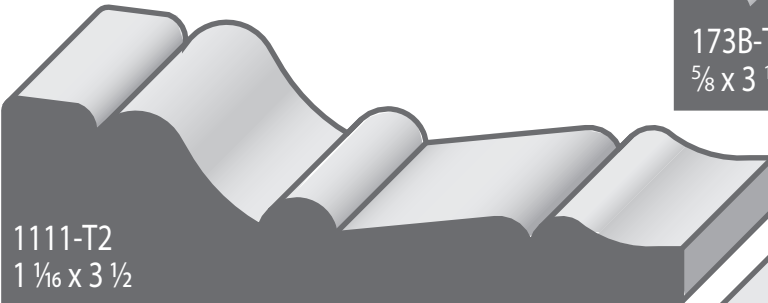
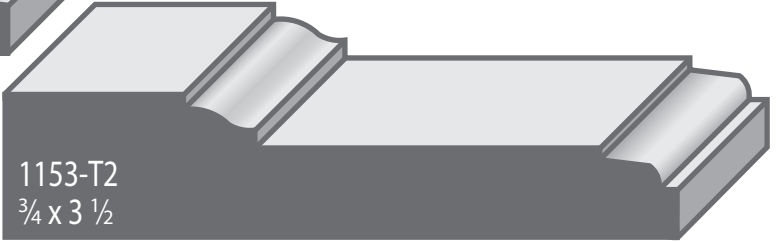
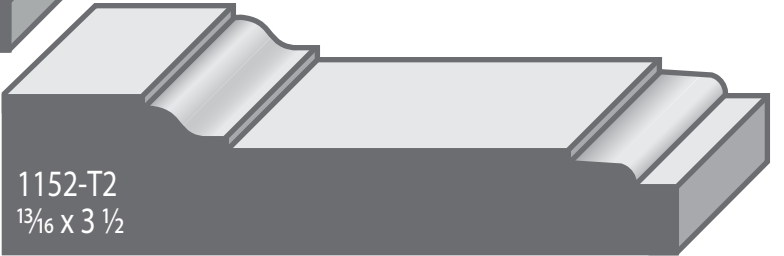
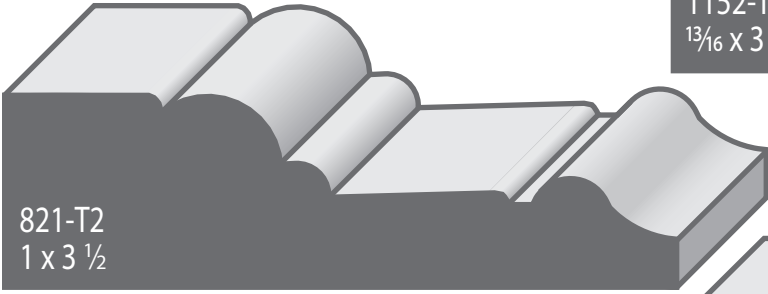
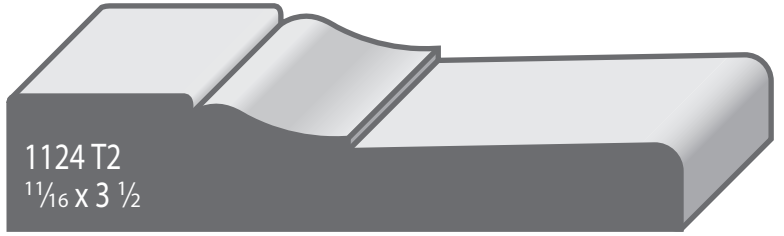
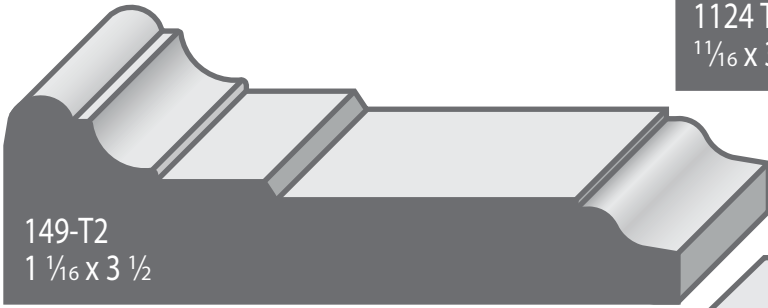

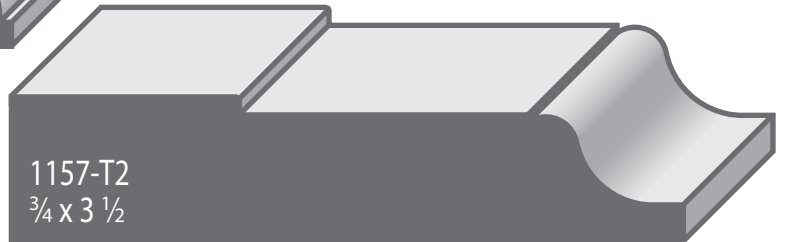
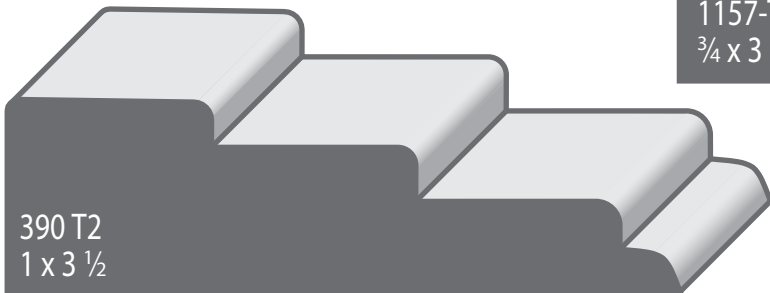
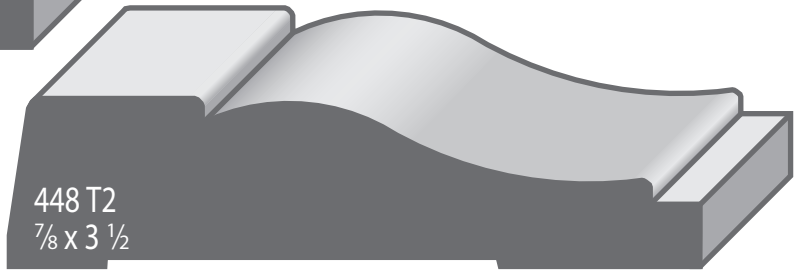
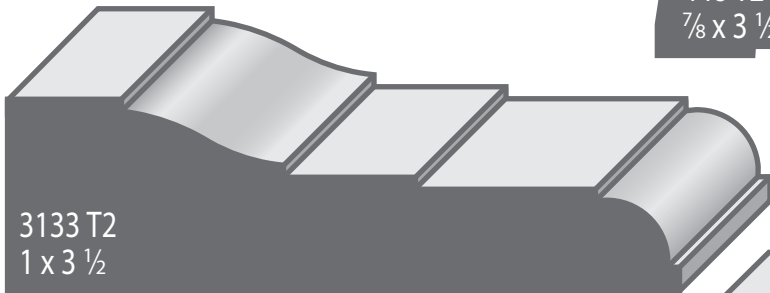
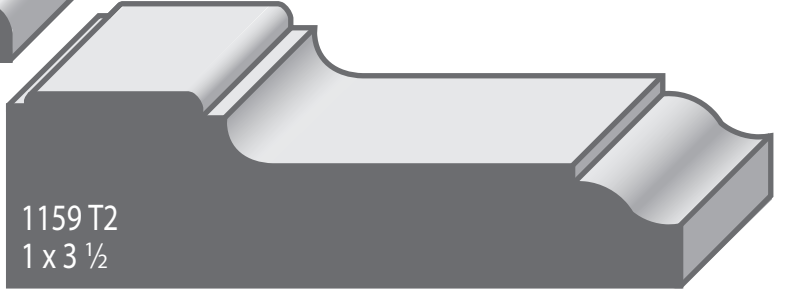
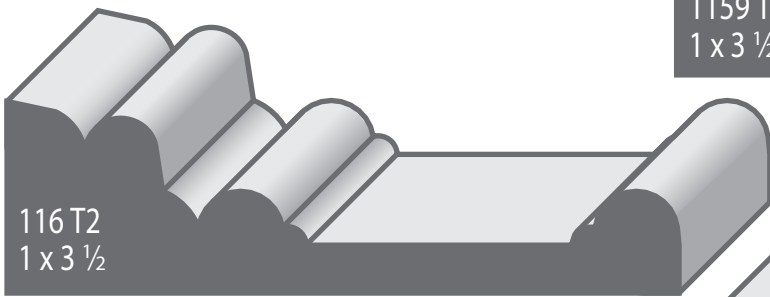
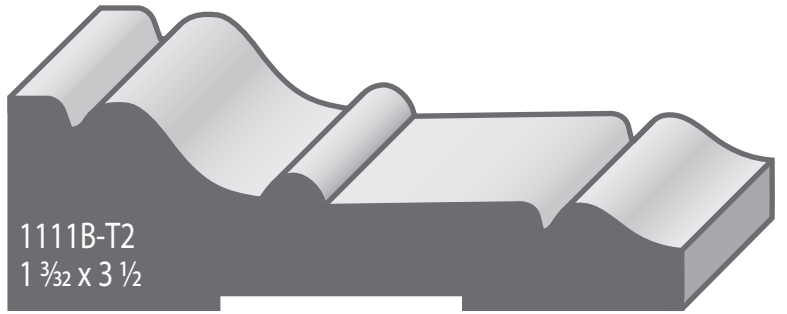
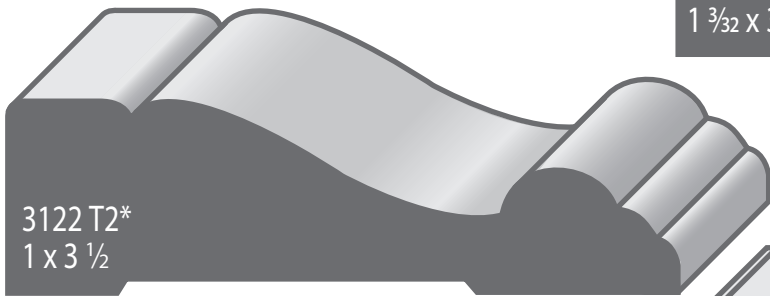

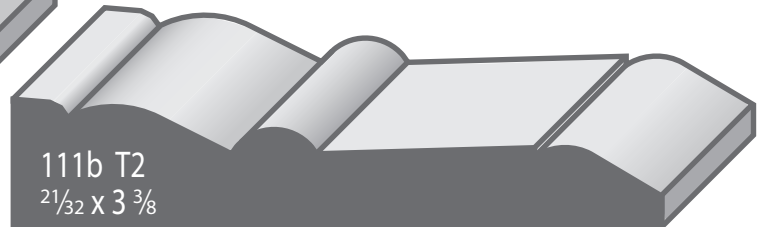
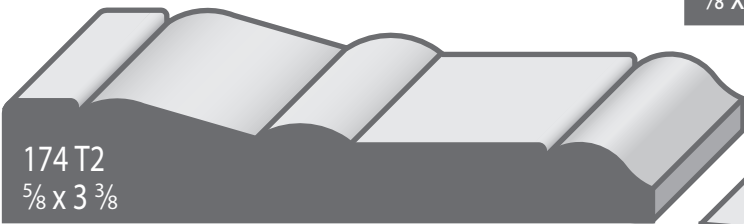
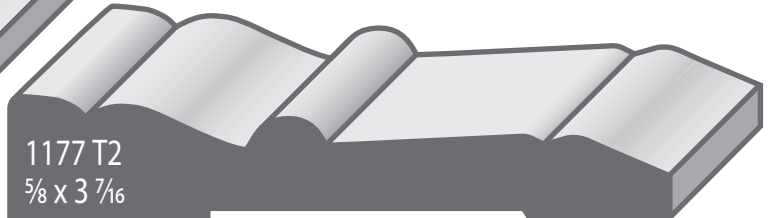
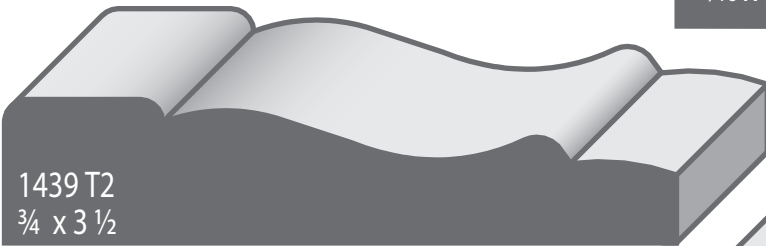
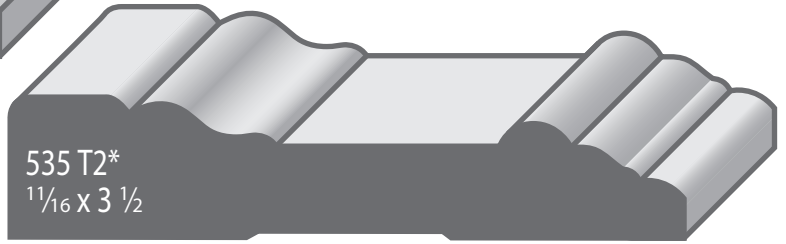

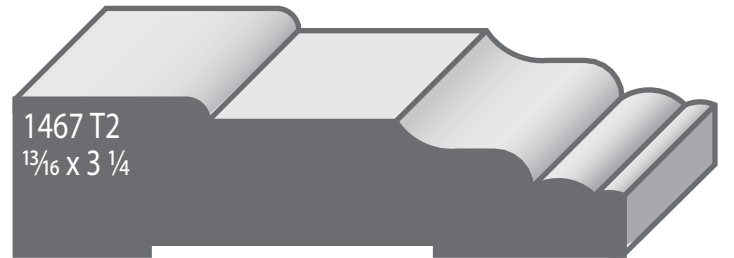
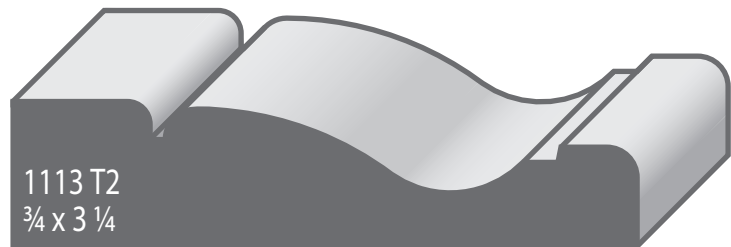
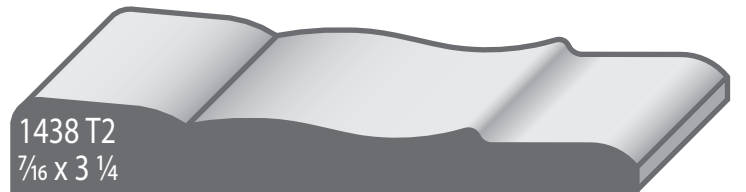
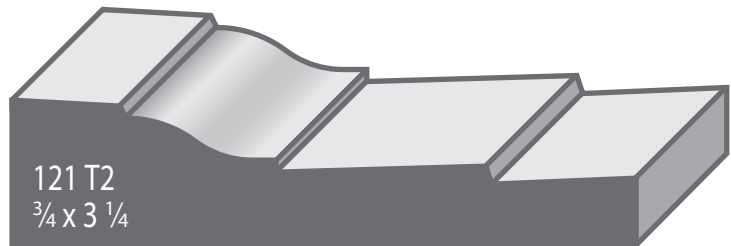
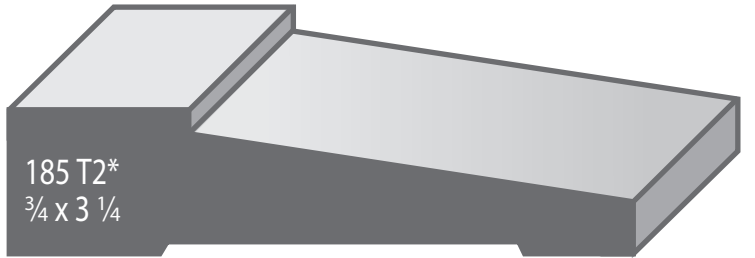
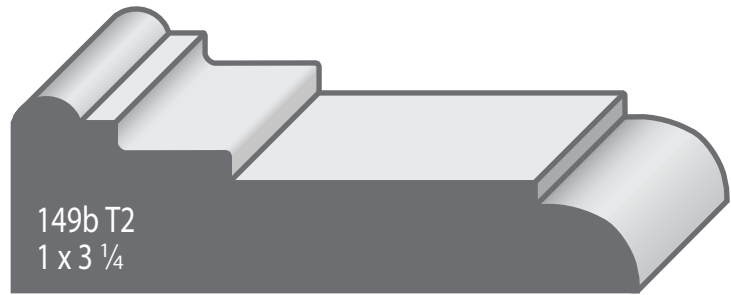
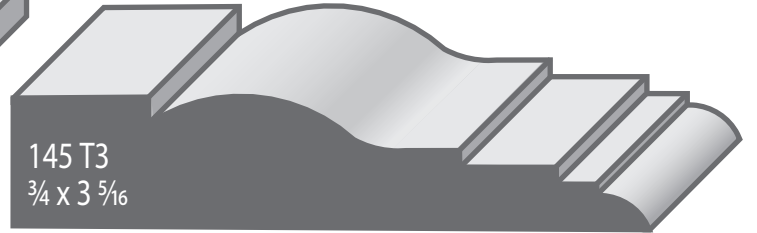
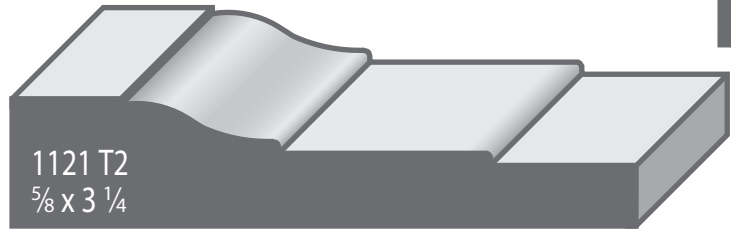
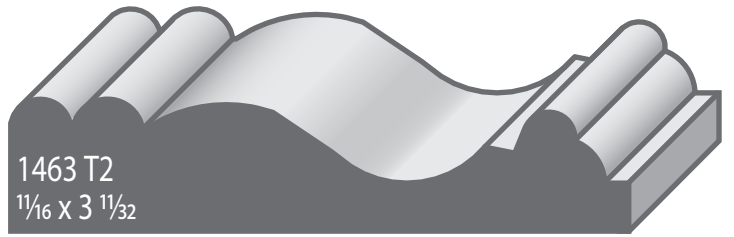
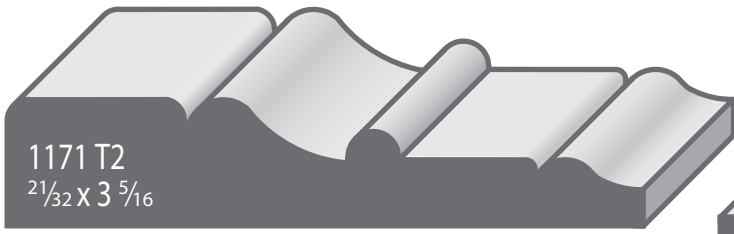

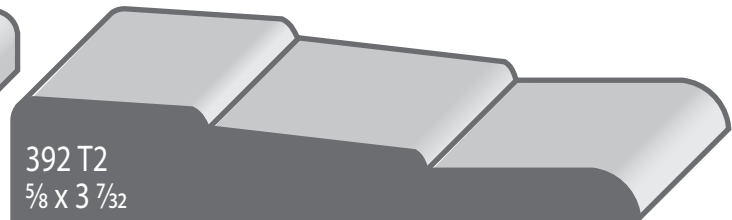
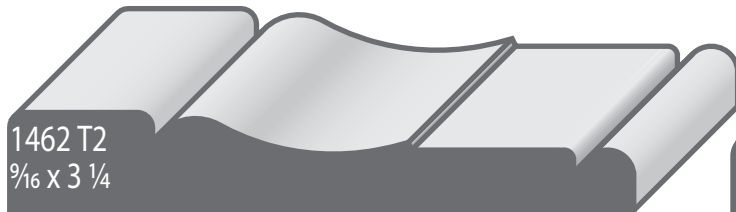
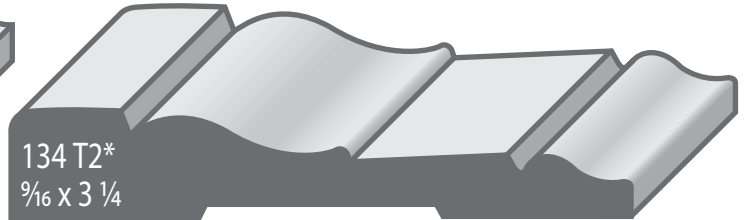
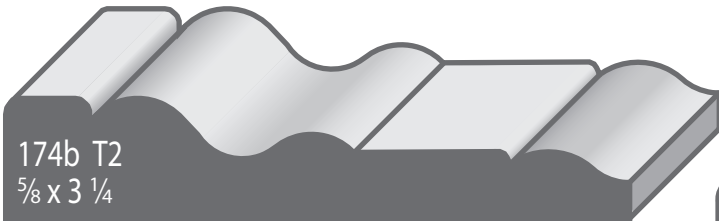
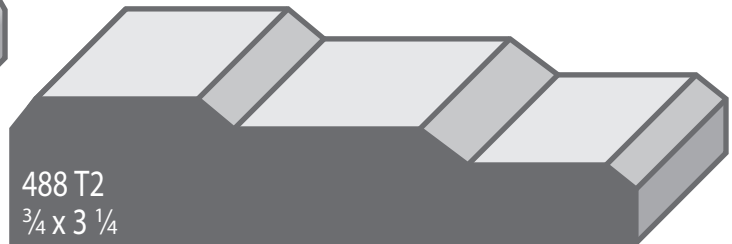
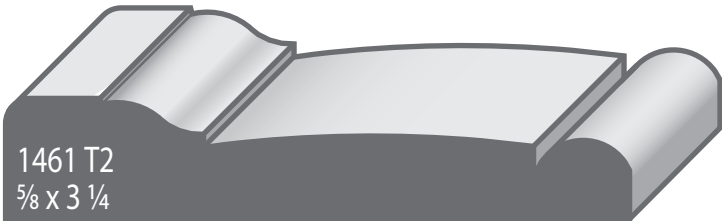
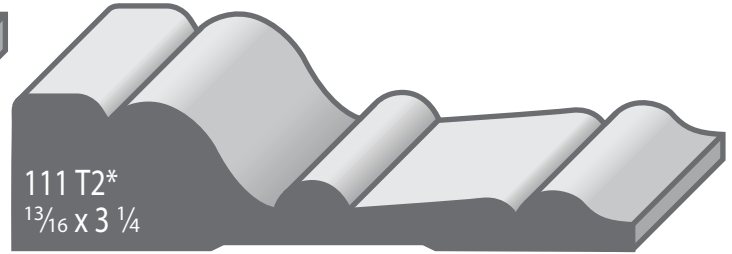
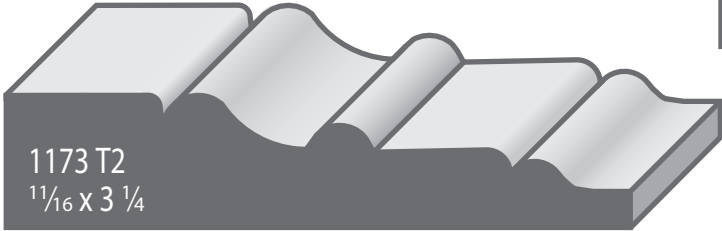
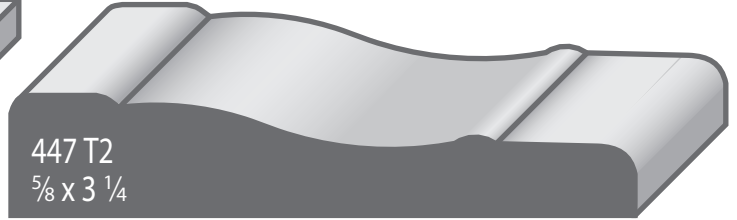
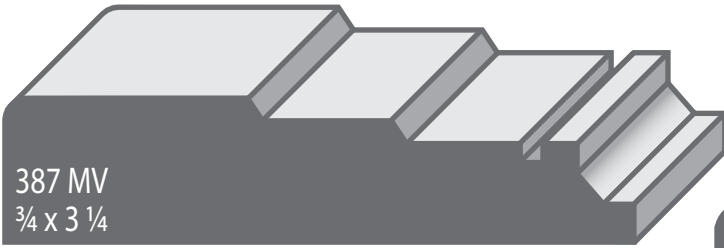

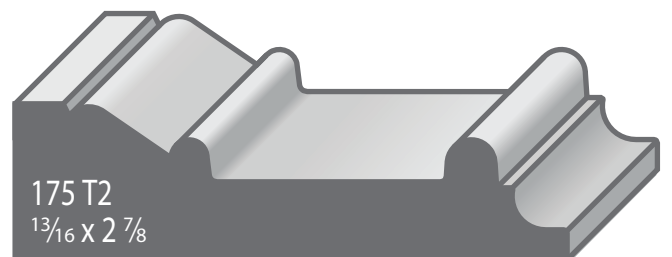
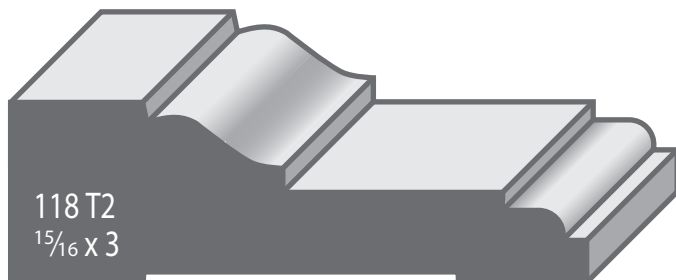
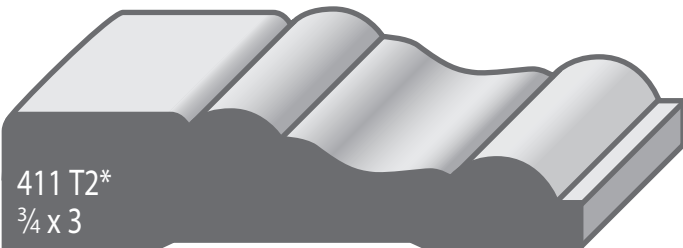
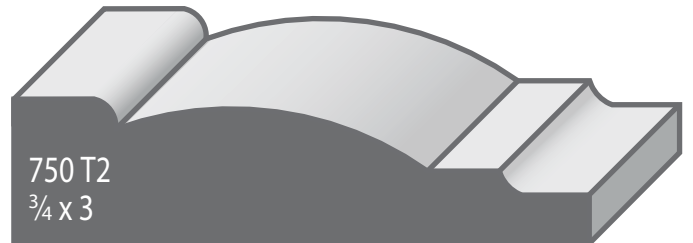
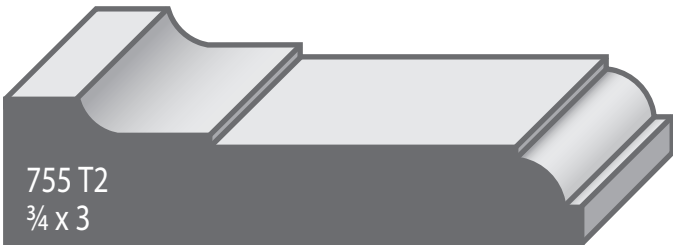
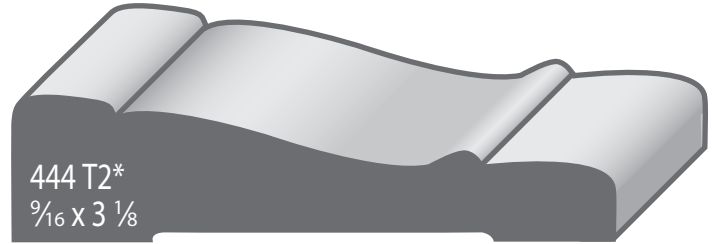
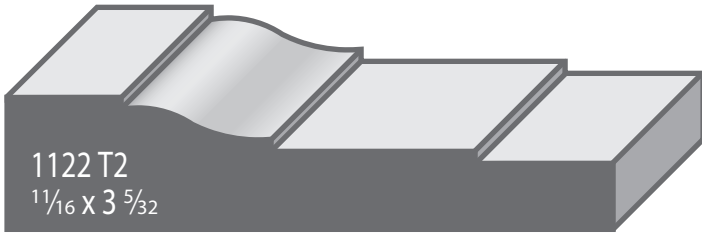
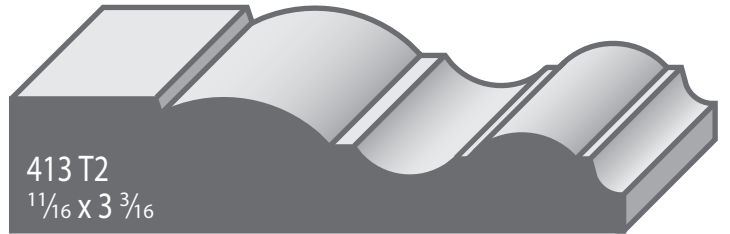
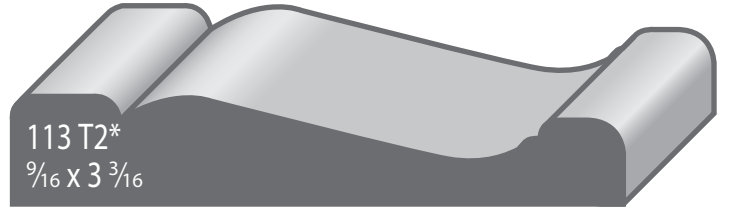
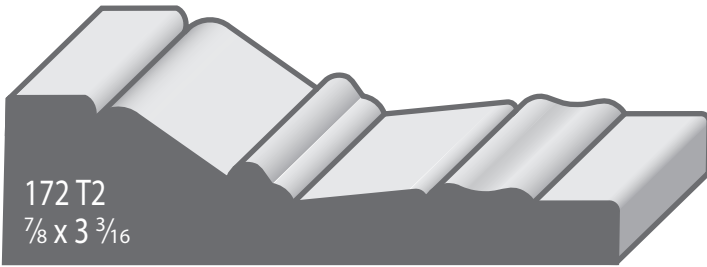

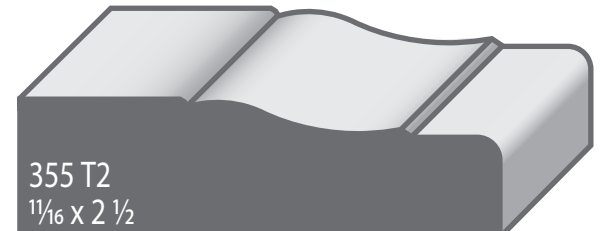
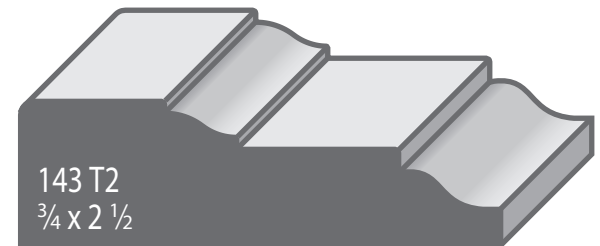
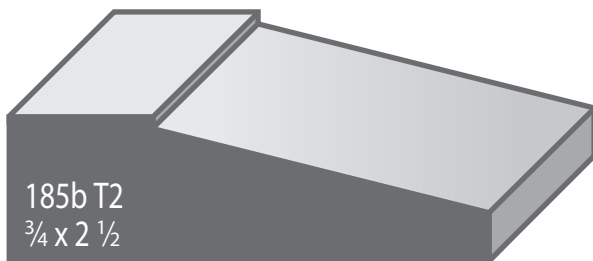
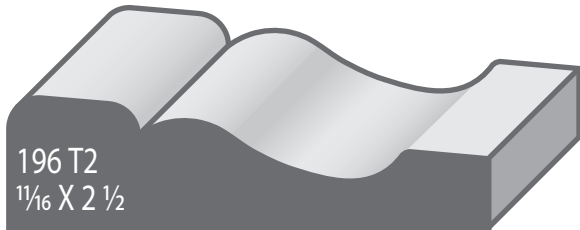
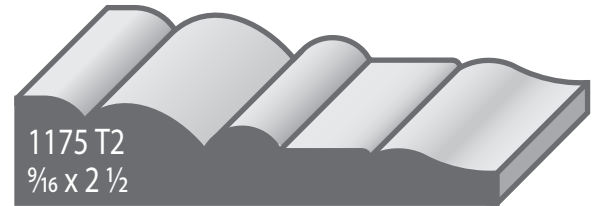
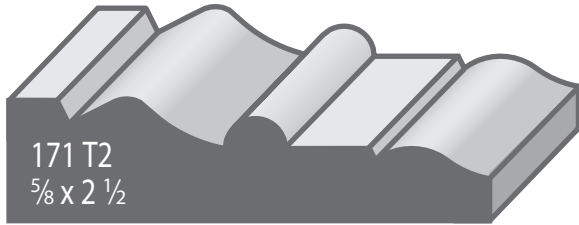
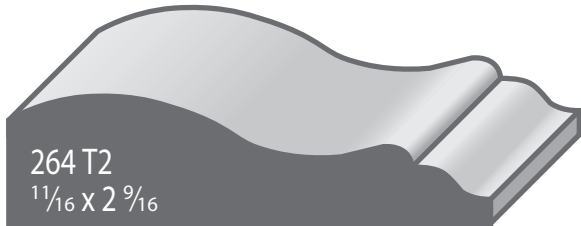
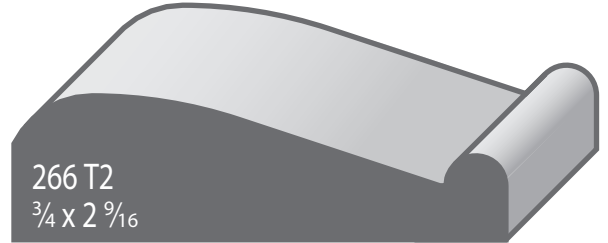
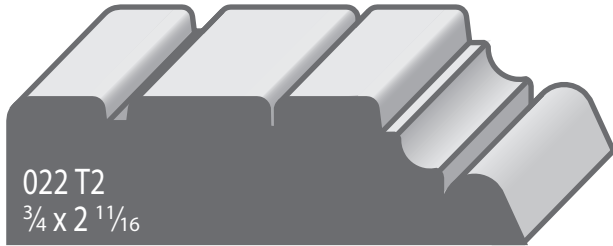
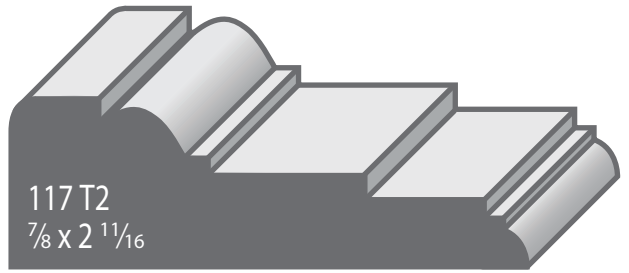
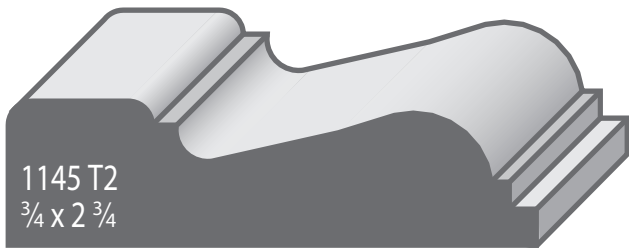

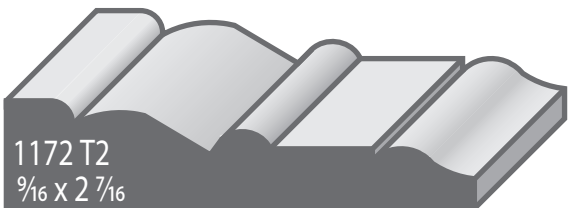
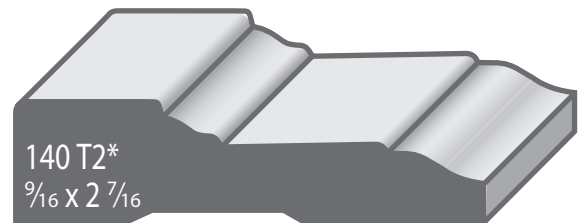
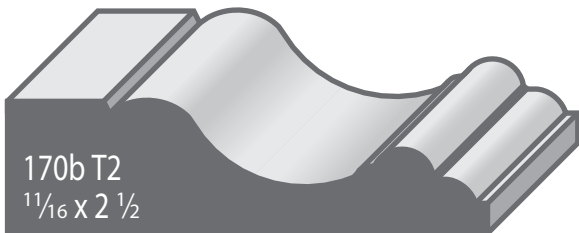
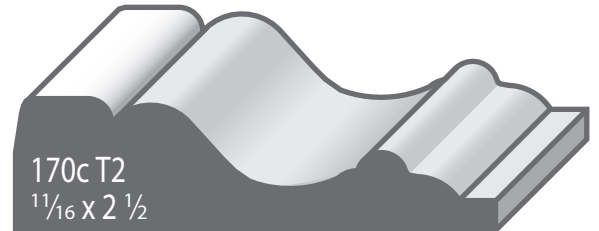
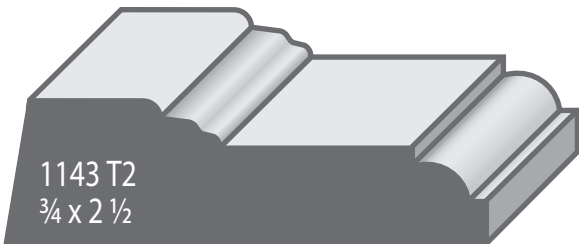
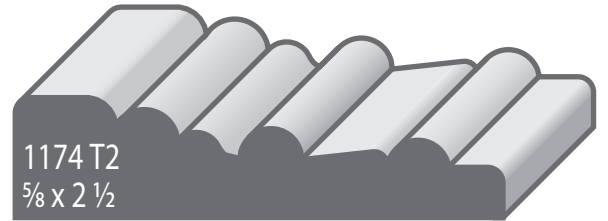
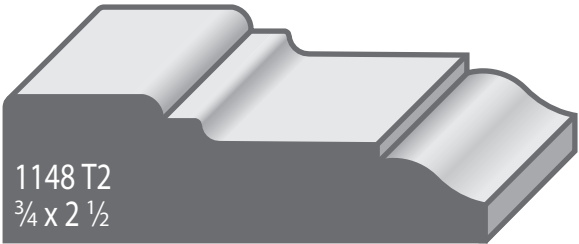
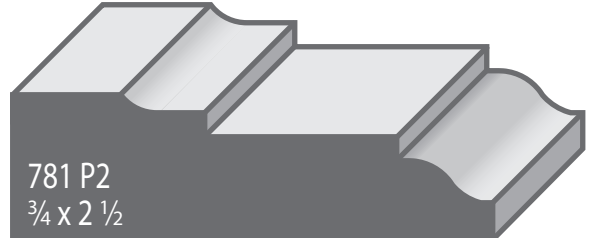
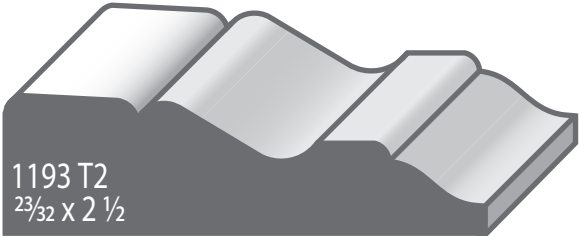
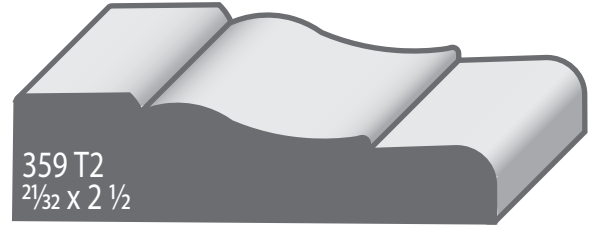
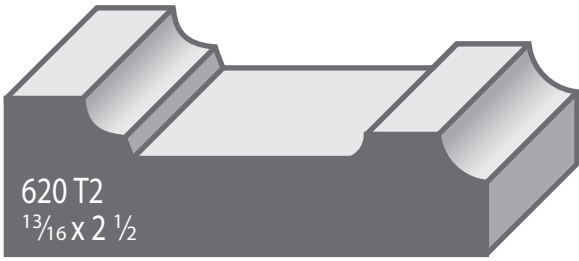

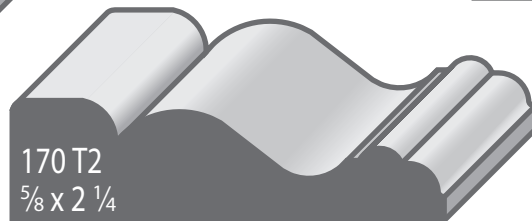
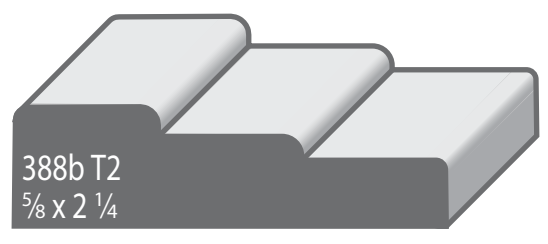
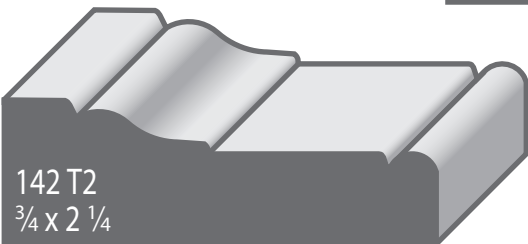
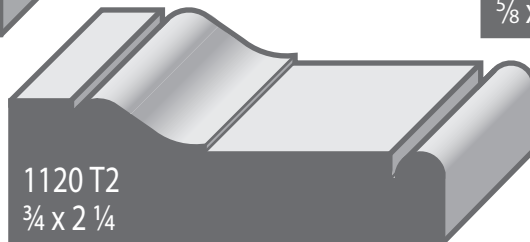
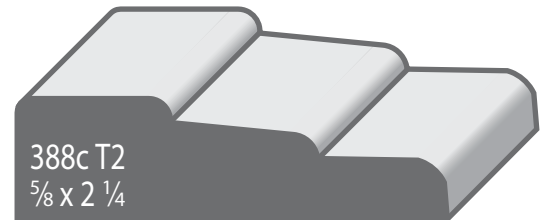
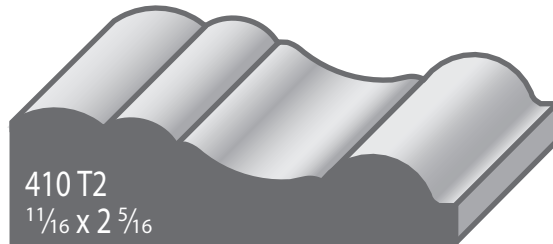
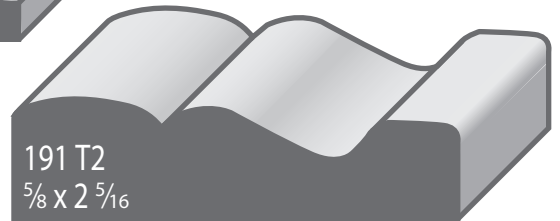
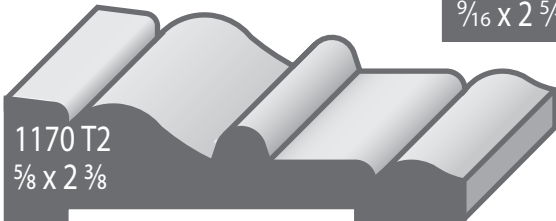
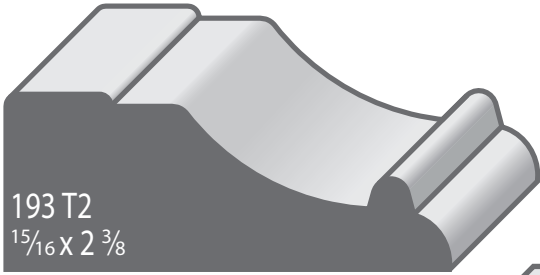

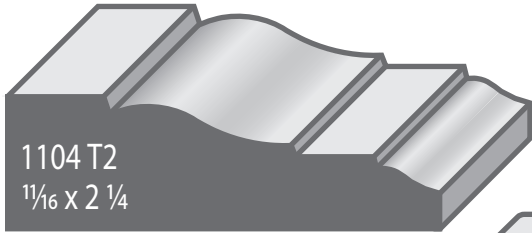

1104 T2
1/16 X 2 1/4

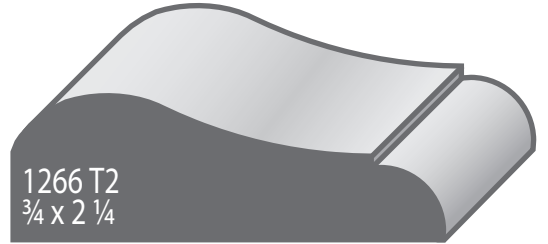

1266 T2
3/4 X 2 1/4

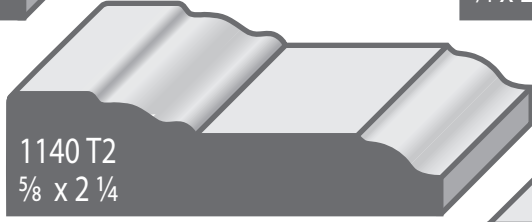

1140 T2
5/8 X 2 1/4

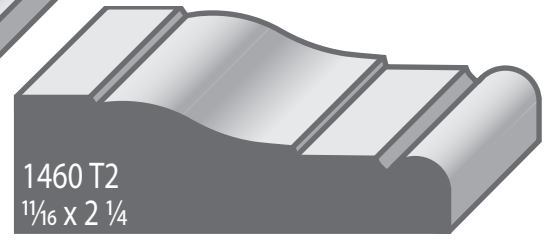

1460 T2
1/16 X 2 1/4



808 T2
3/4 X 2 1/4

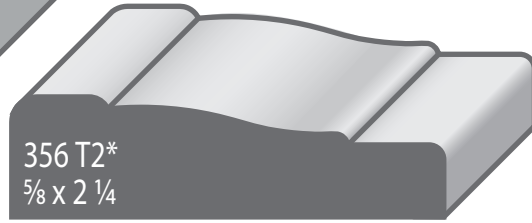

356 T2*
5/8 X 2 1/4

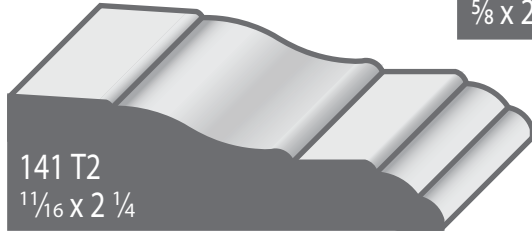

141 T2
1/16 X 2 1/4

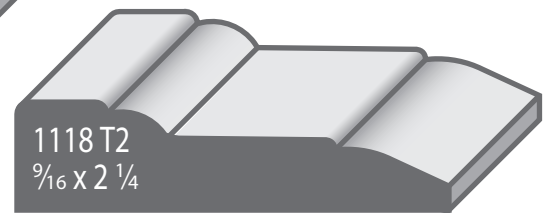

1118 T2
9/16 X 2 1/4

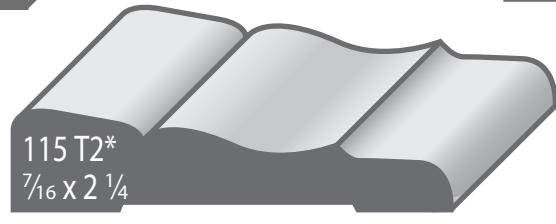

115 T2*
7/16 X 2 1/4

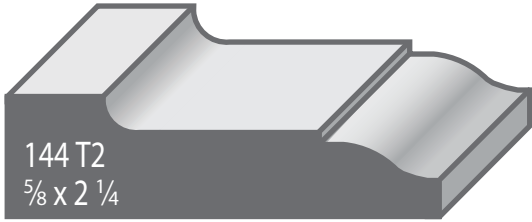

144 T2
5/8 X 2 1/4

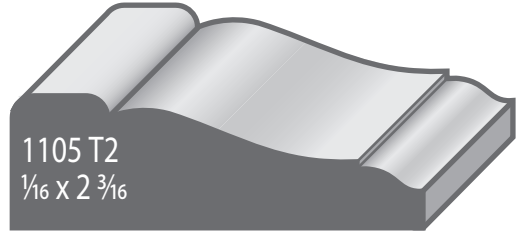

1105 T2
1/16 X 2 3/16

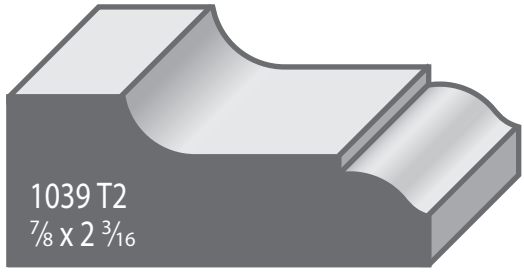

1039 T2
7/8 X 2 3/16

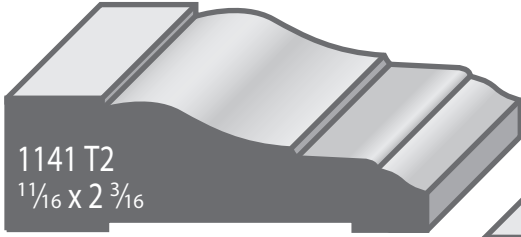

1141 T2
 $1\frac{1}{16} \times 2\frac{3}{16}$



357 T2
 $\frac{9}{16} \times 2\frac{3}{16}$

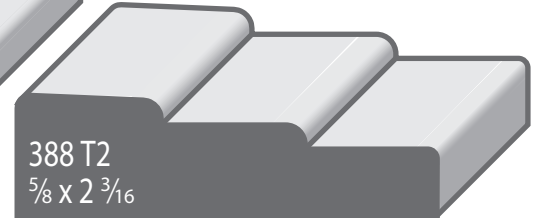

388 T2
 $\frac{5}{8} \times 2\frac{3}{16}$



1203 T2
 $\frac{3}{4} \times 2\frac{3}{16}$

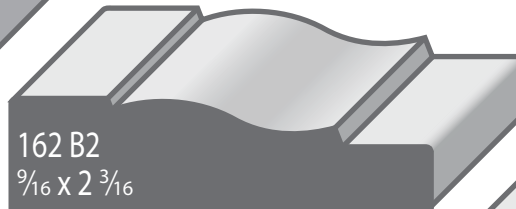

162 B2
 $\frac{9}{16} \times 2\frac{3}{16}$

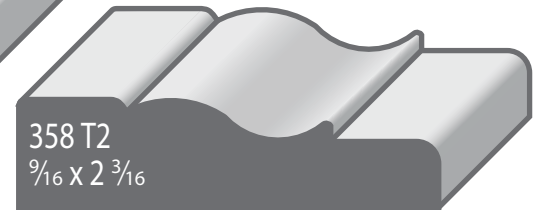

358 T2
 $\frac{9}{16} \times 2\frac{3}{16}$



1804 T2
 $\frac{3}{4} \times 2\frac{1}{8}$

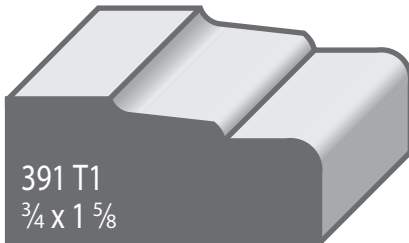

391 T1
 $\frac{3}{4} \times 1\frac{5}{8}$

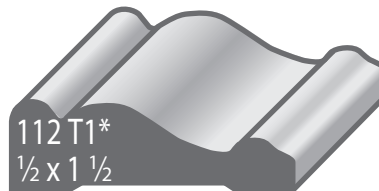

112 T1*
 $\frac{1}{2} \times 1\frac{1}{2}$



248 P2
1 x 2

Pair with Plinth #1037 T2
and Base 331 BV

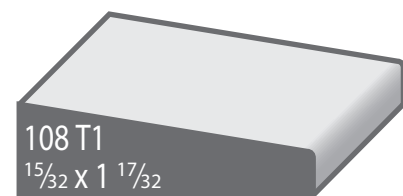
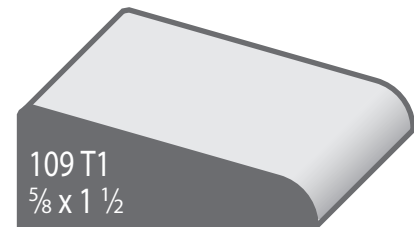
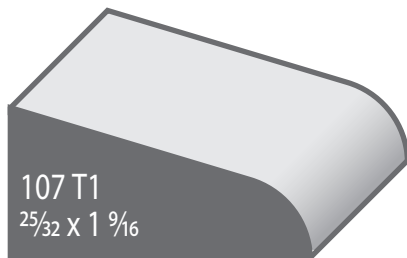
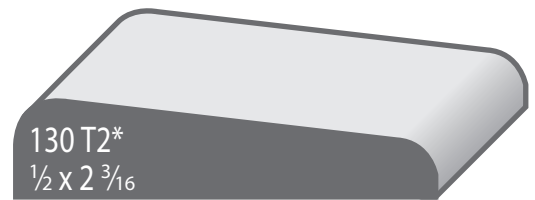
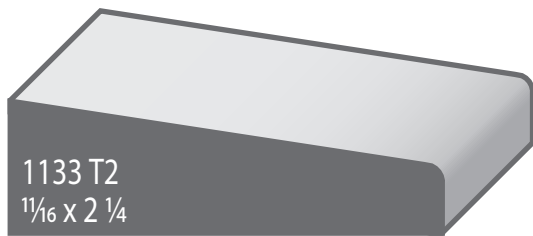
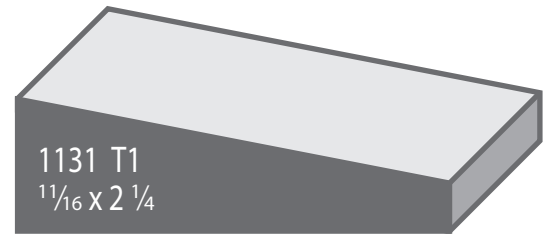
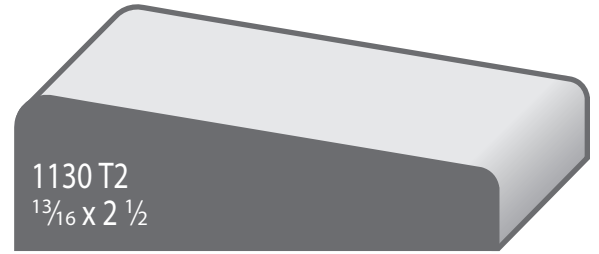
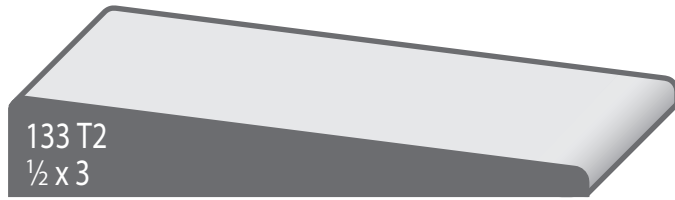

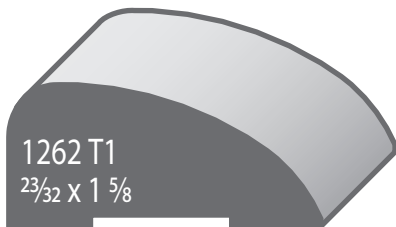
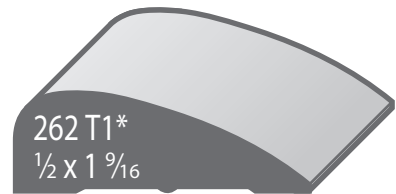
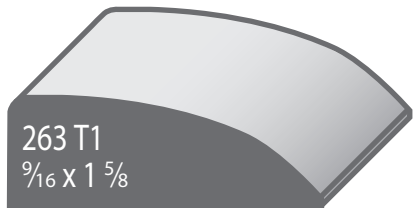
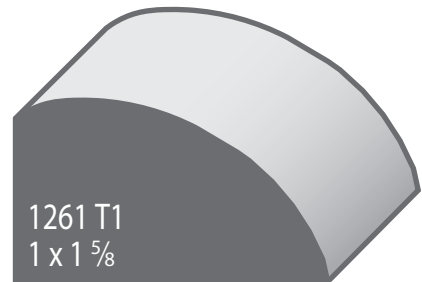
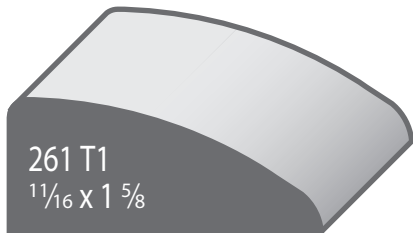
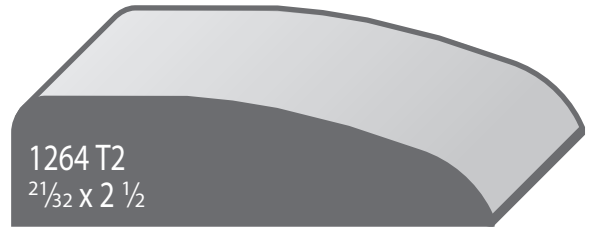

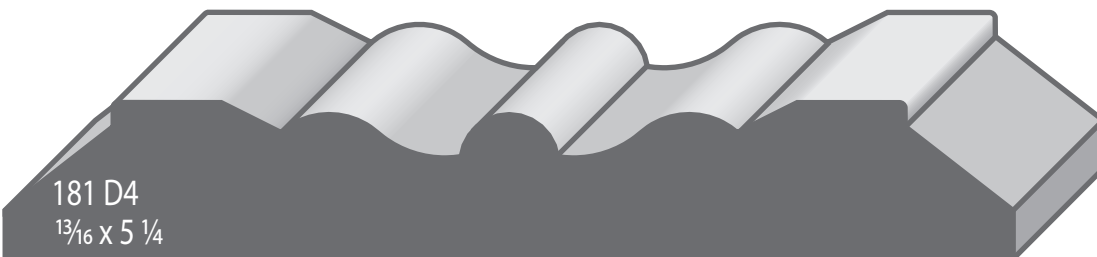
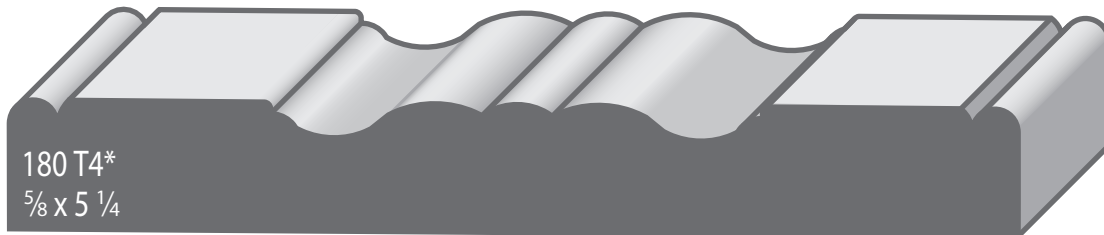
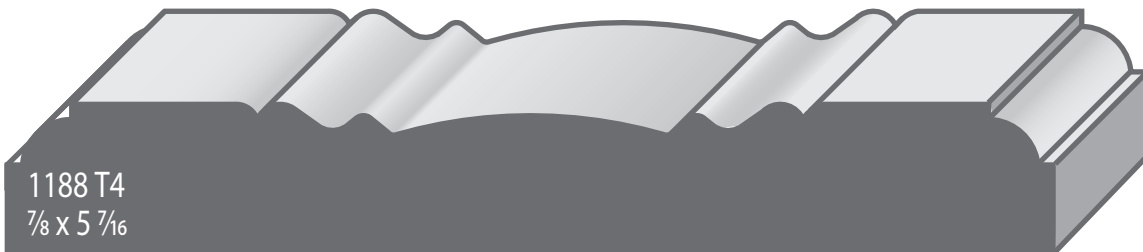
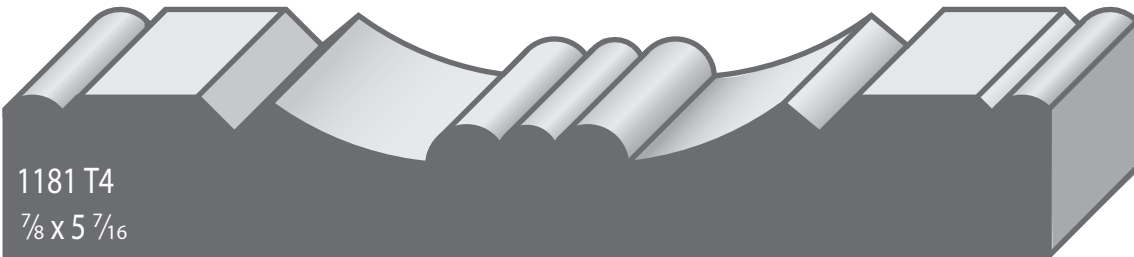
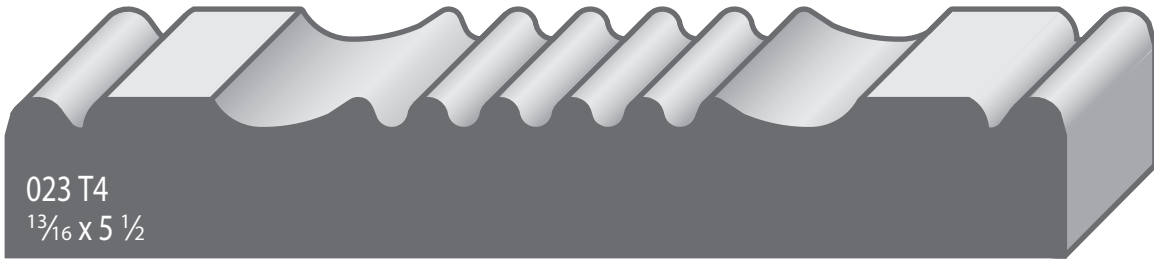
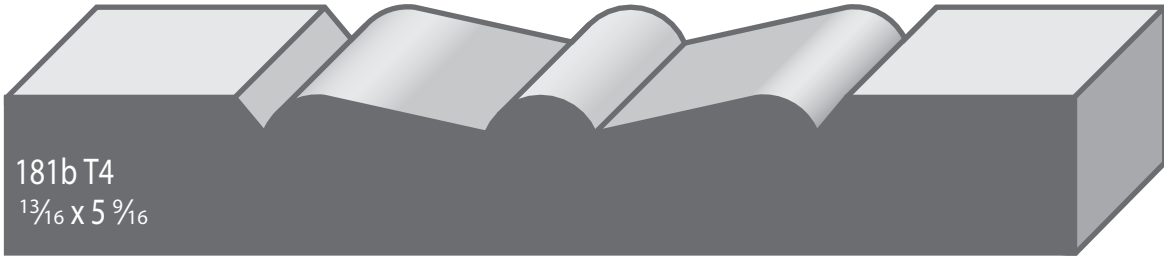

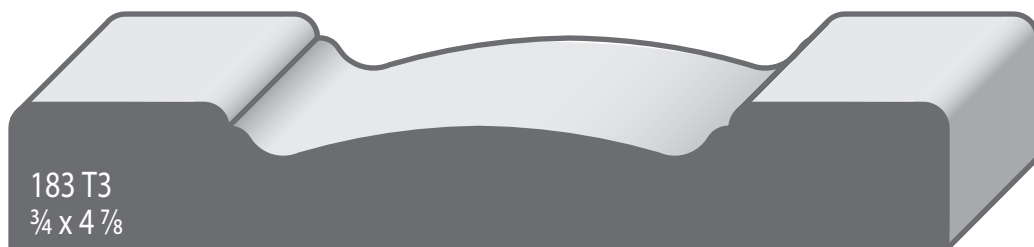
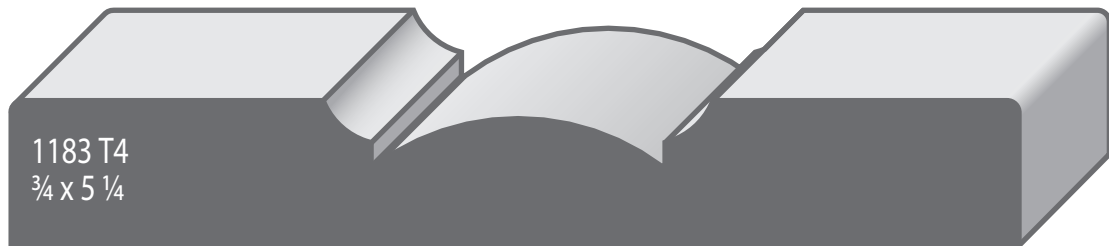
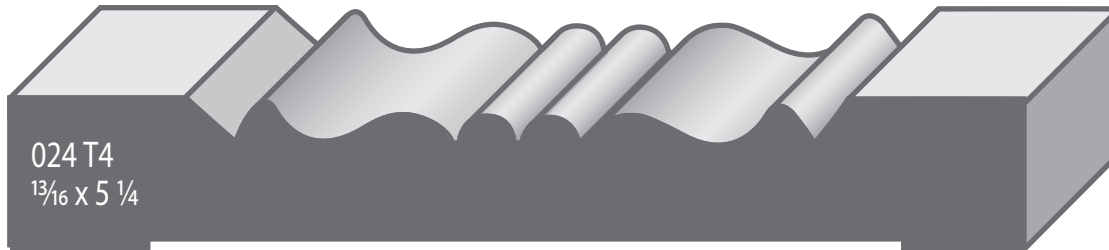
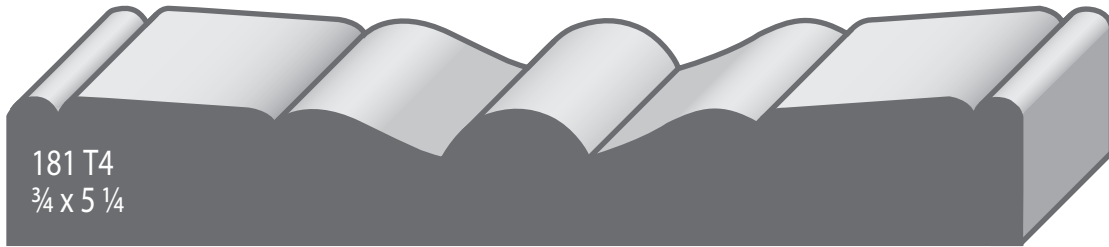
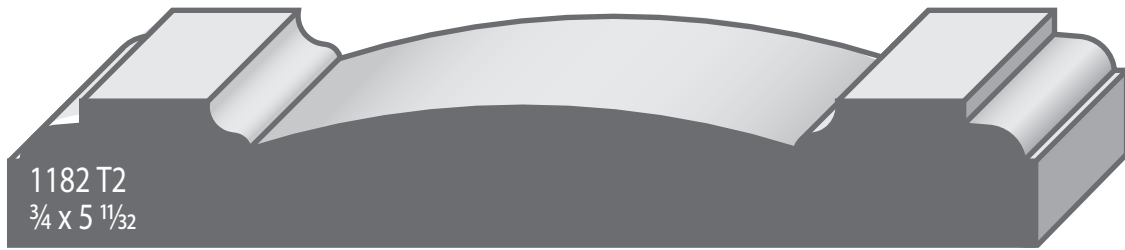

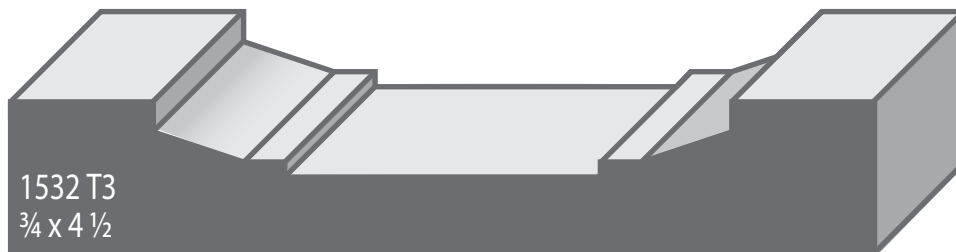
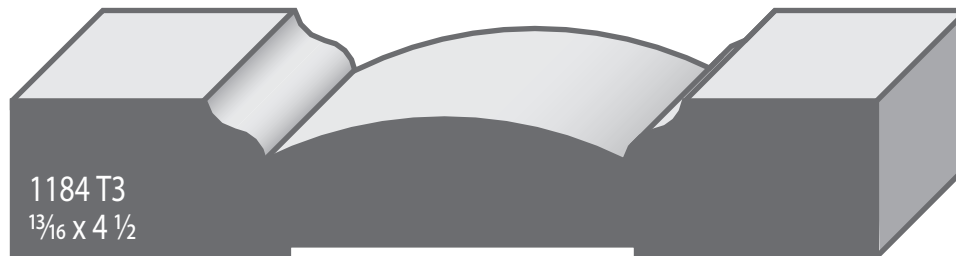
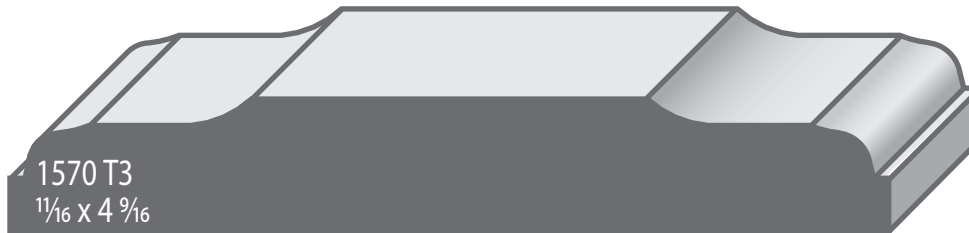
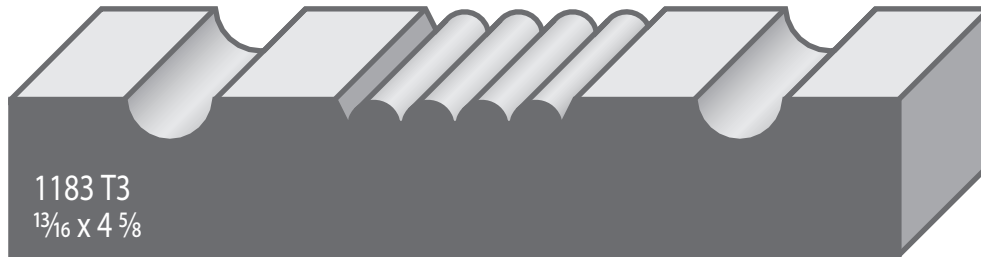
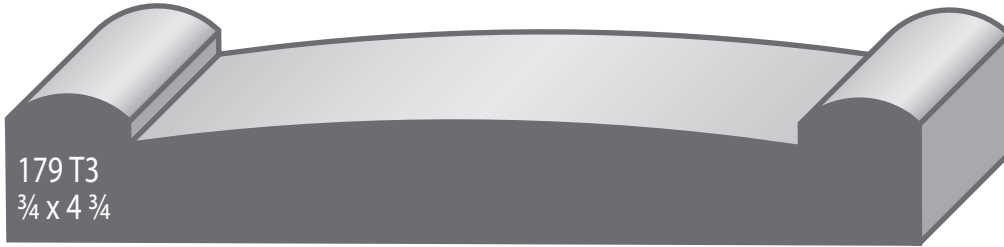

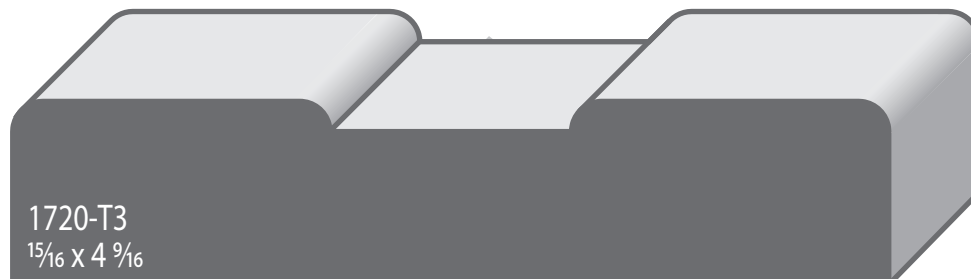
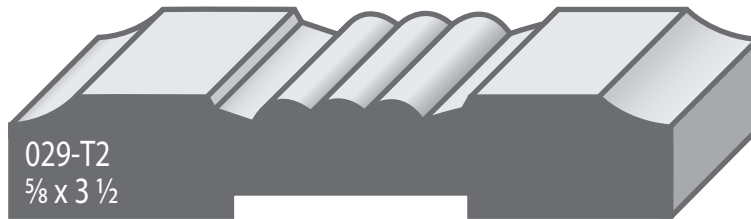
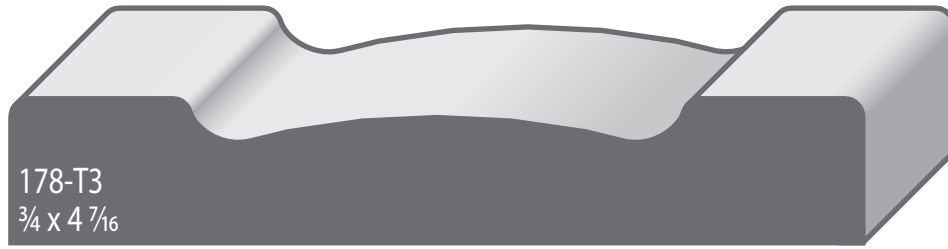

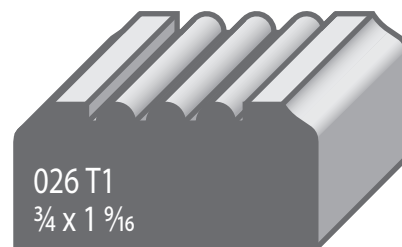
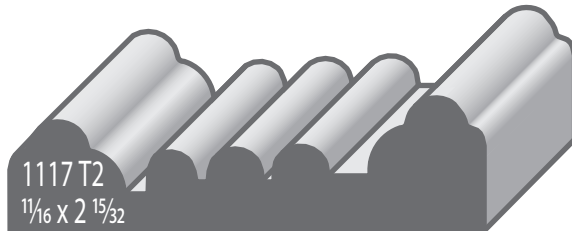
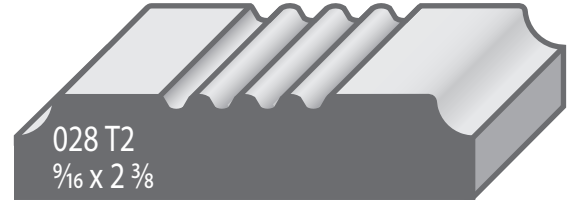
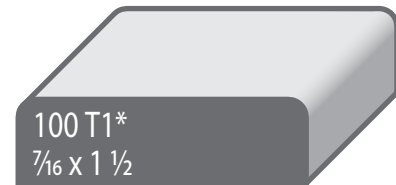
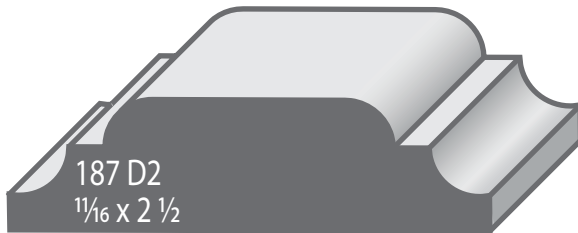
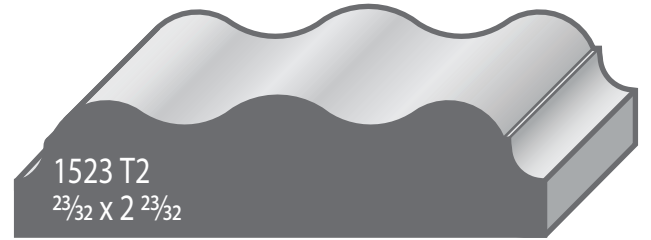
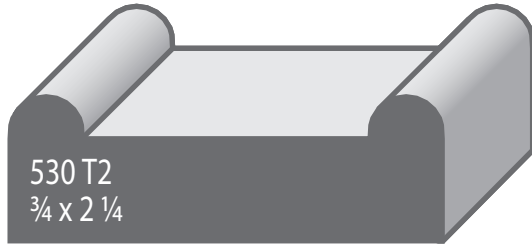

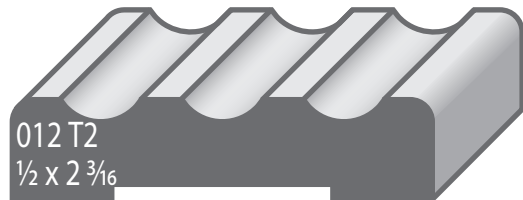
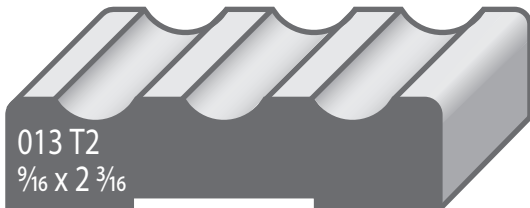
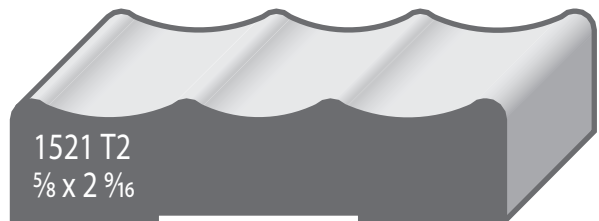
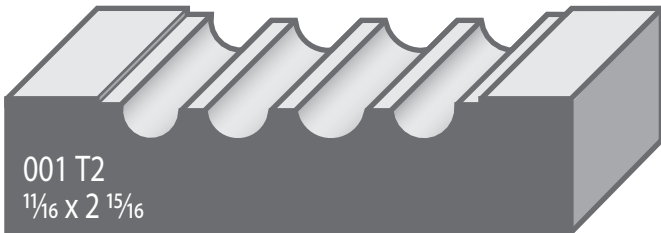
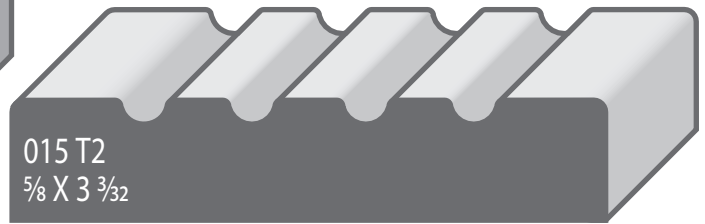
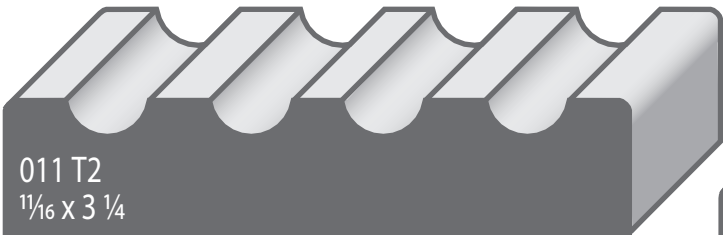
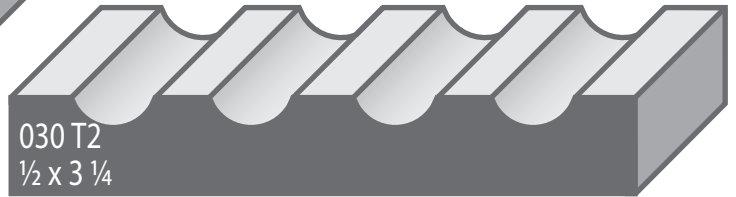
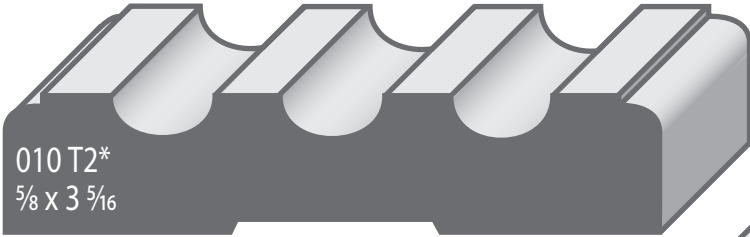
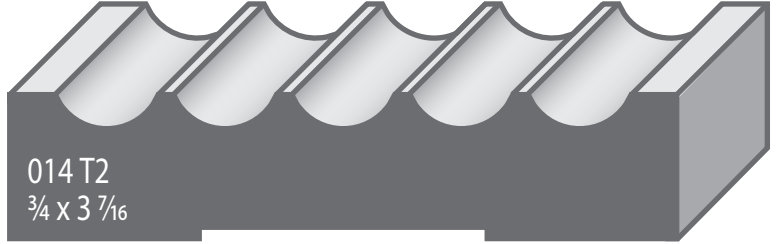
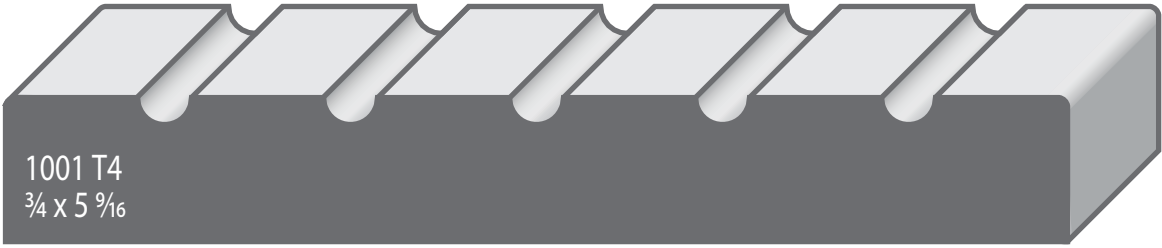

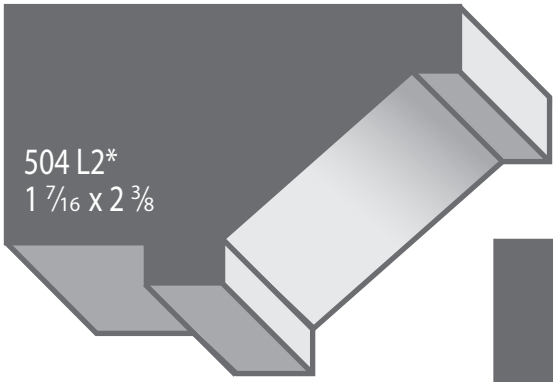

504 L2*
1 7/16 x 2 3/8

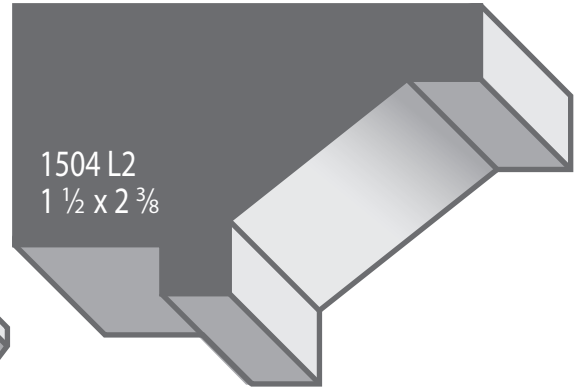

1504 L2
1 1/2 x 2 3/8

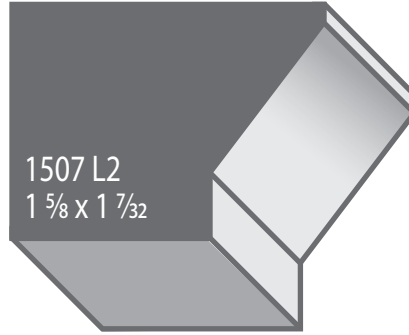

1507 L2
1 5/8 x 1 7/32

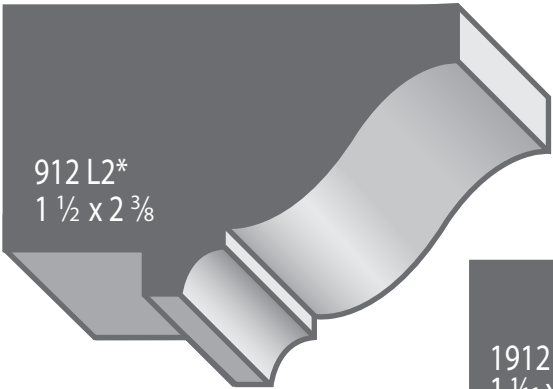

912 L2*
1 1/2 x 2 3/8

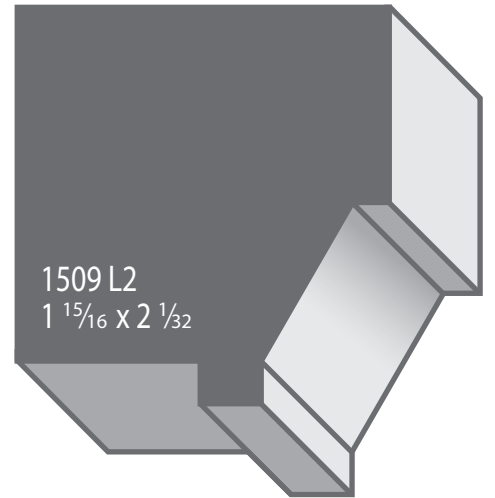

1509 L2
1 15/16 x 2 1/32

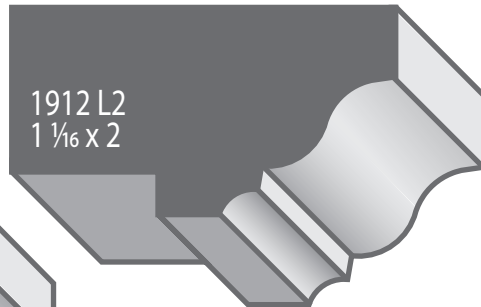

1912 L2
1 1/16 x 2

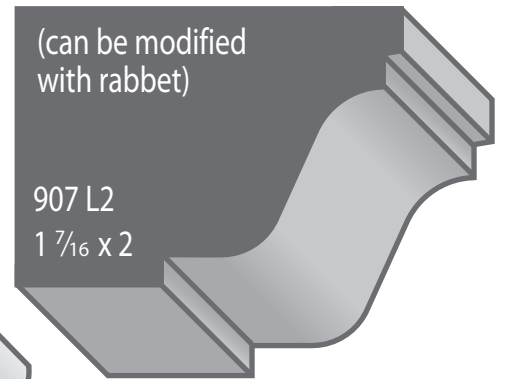

(can be modified
with rabbet)

907 L2
1 7/16 x 2

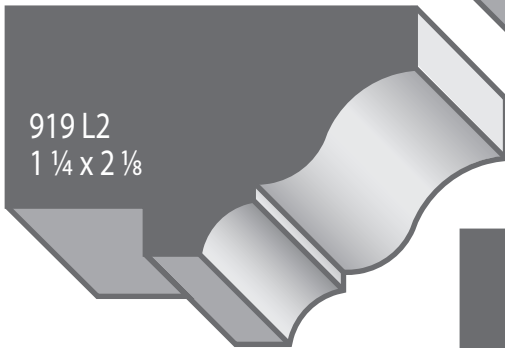

919 L2
1 1/4 x 2 1/8

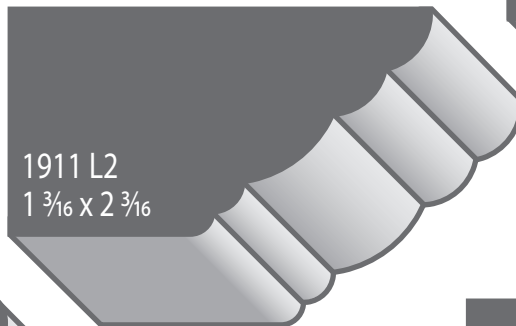

1911 L2
1 3/16 x 2 3/16

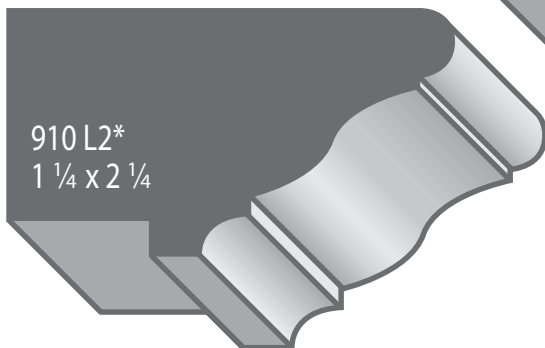

910 L2*
1 1/4 x 2 1/4

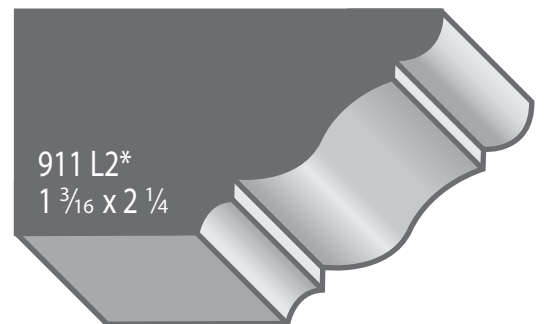

911 L2*
1 3/16 x 2 1/4

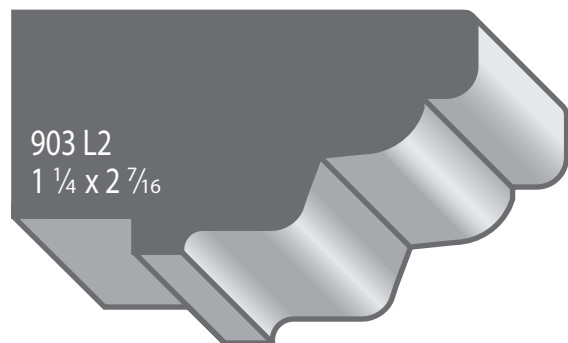
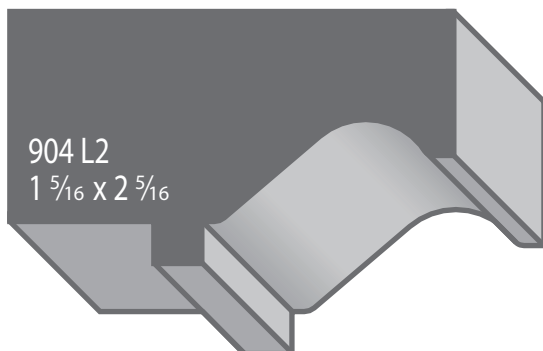
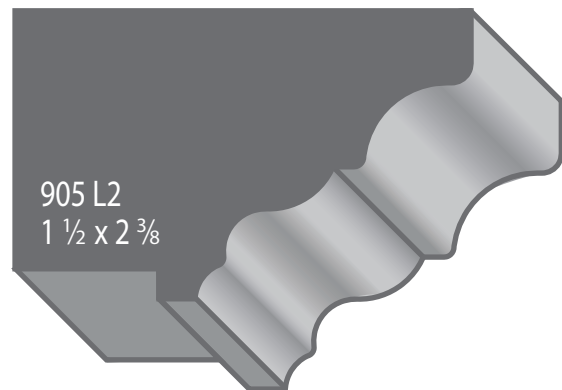
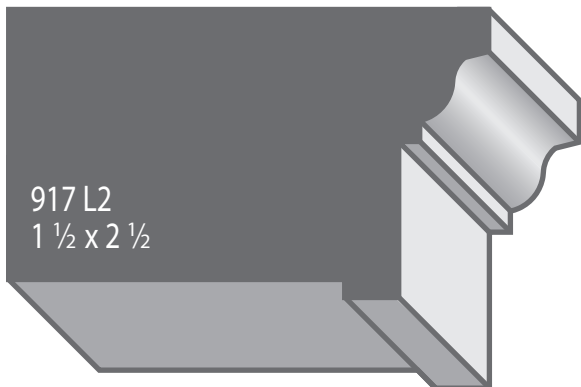
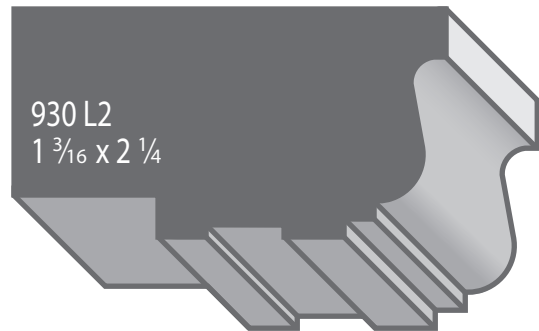
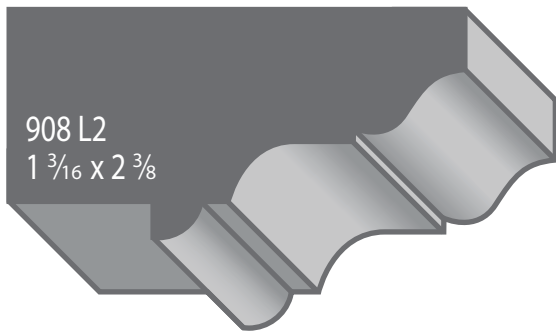
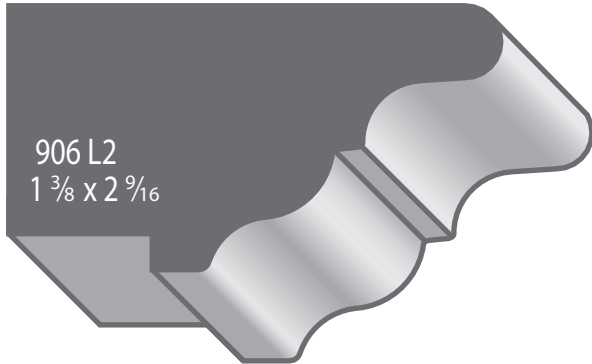
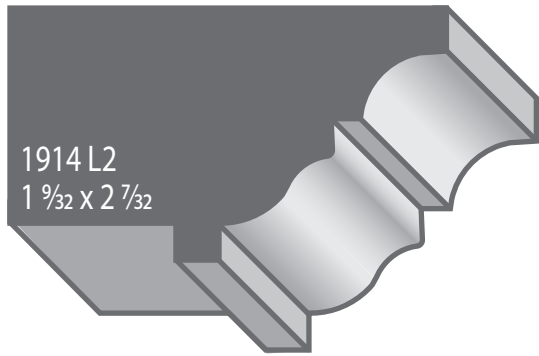

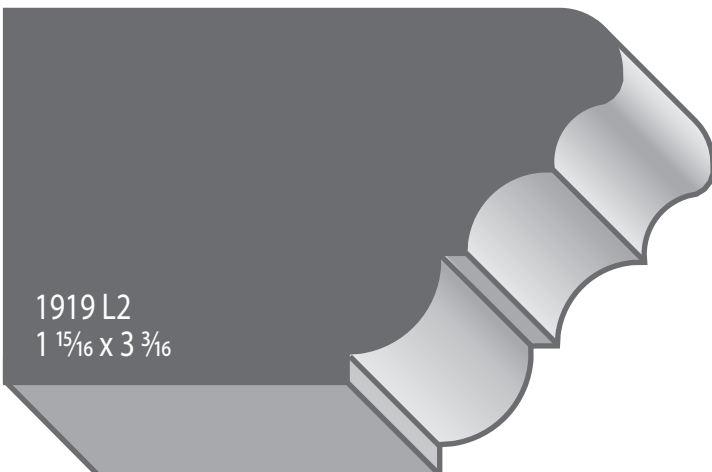
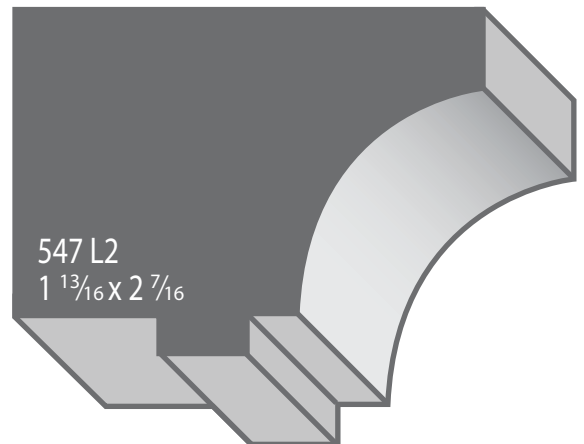
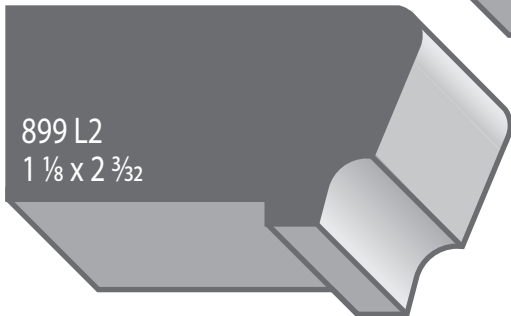
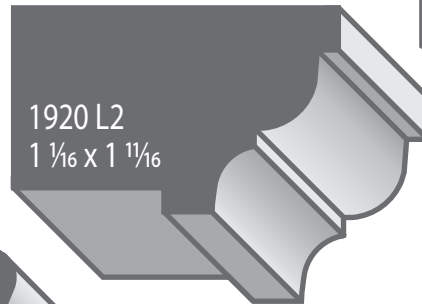
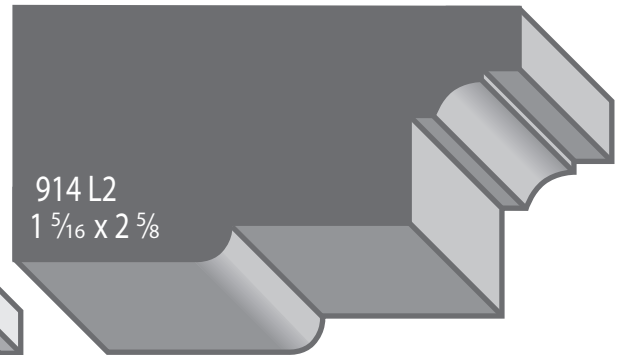
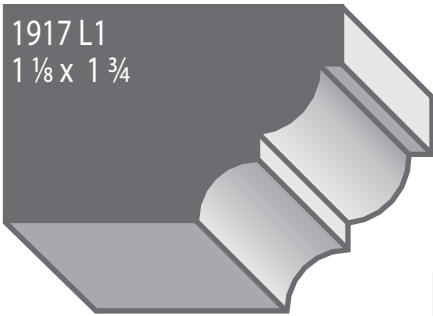
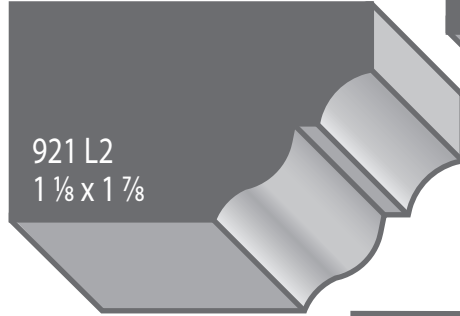
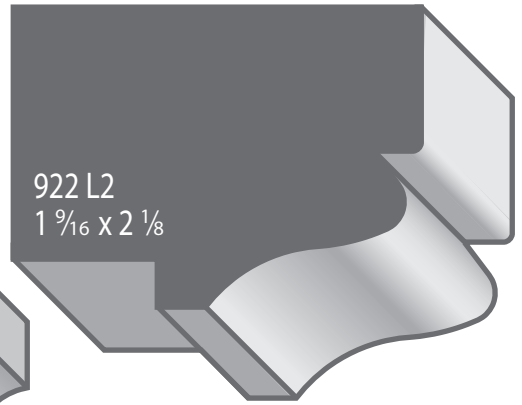
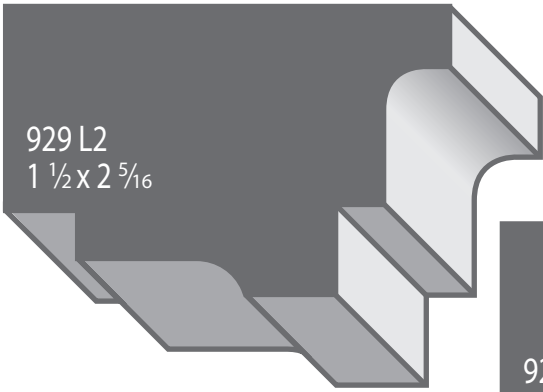

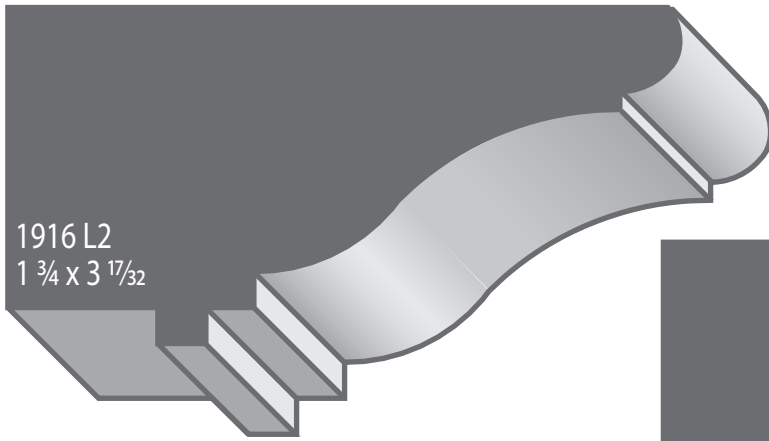

1916 L2
1 3/4 x 3 17/32

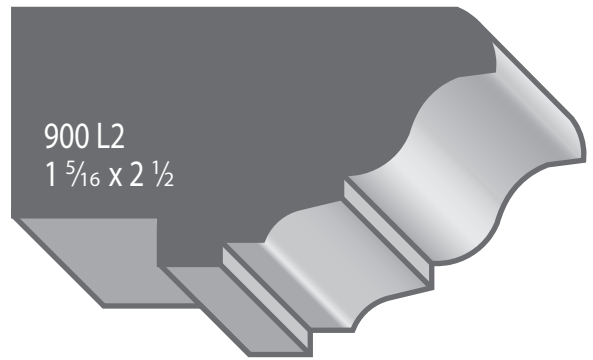

900 L2
1 5/16 x 2 1/2

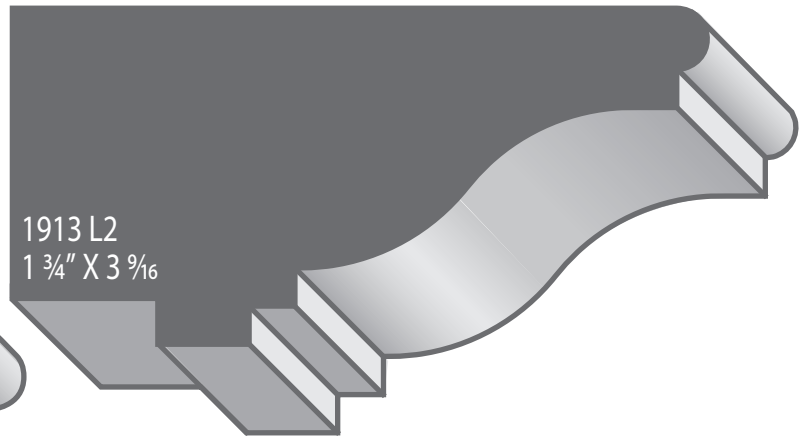

1913 L2
1 3/4" X 3 9/16

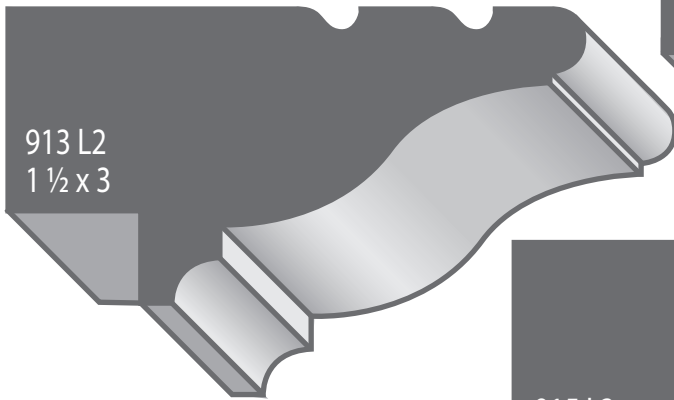

913 L2
1 1/2 x 3

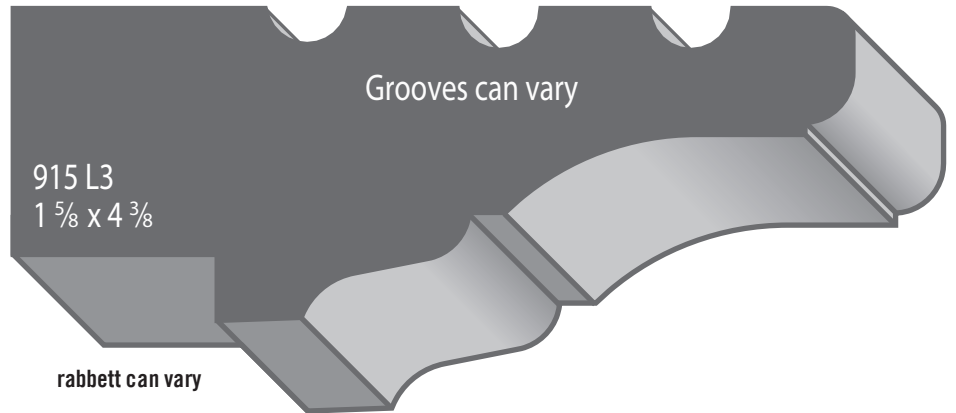

915 L3
1 5/8 x 4 3/8

Grooves can vary

rabbett can vary

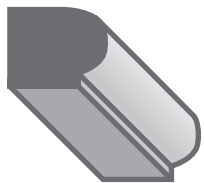

953B-S1
1/2 x 3/8

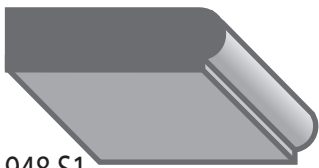

948 S1
5/16 x 1 1/8



953 S1
3/8 x 1 5/8



949 S1
1/2 x 1 5/8



950 S1*
7/16 x 1 1/4



503 S1*
1/2 x 1 1/8



955 S1*
1/2 x 1 1/4



954 M1
1 1/16 x 1 1/2

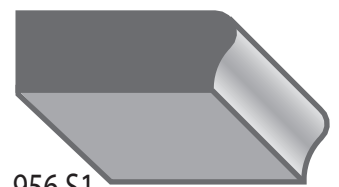

956 S1
3/8 x 1 1/8

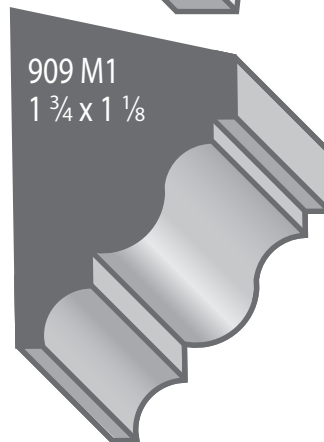
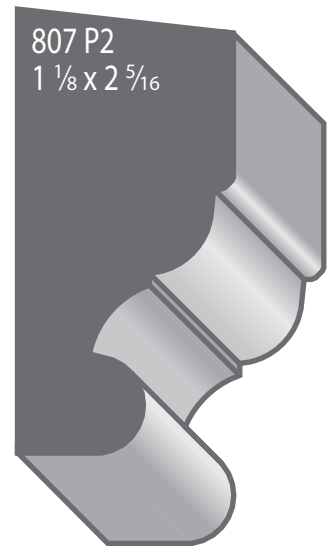

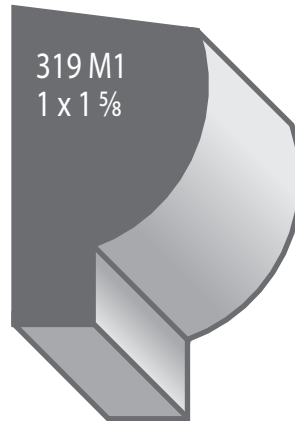
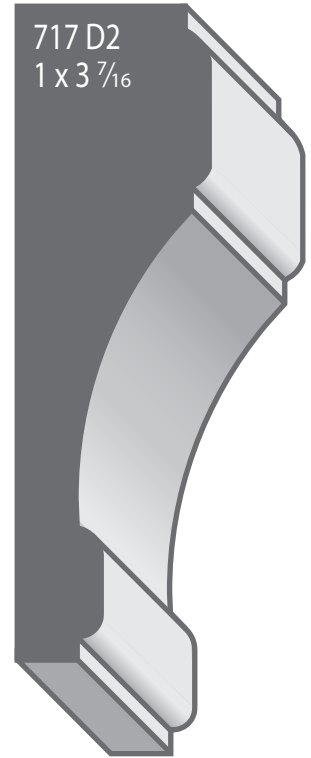
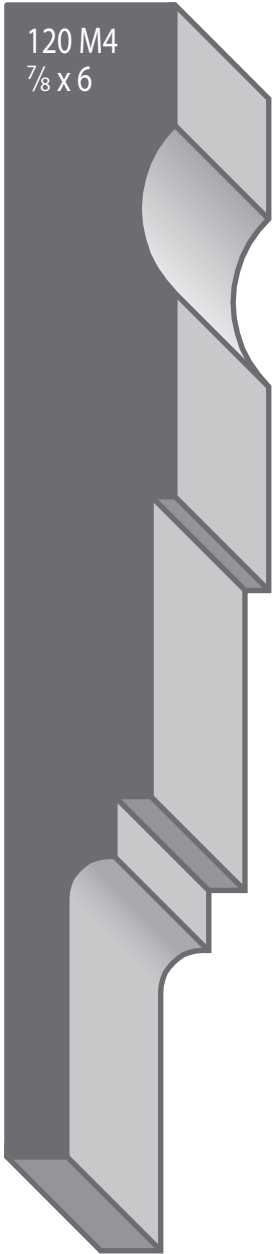



Architrave
753 D4
1 ¹³/₁₆ X 7 ⁵/₁₆



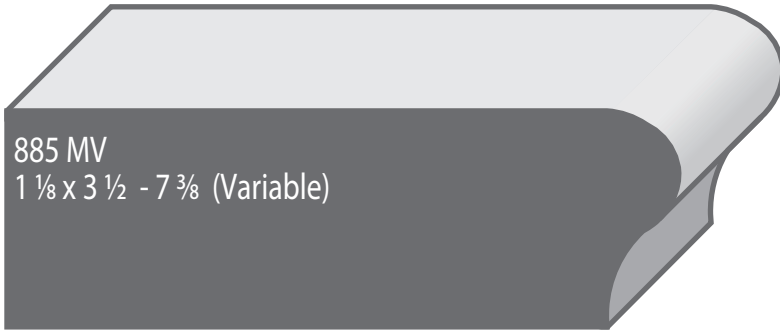
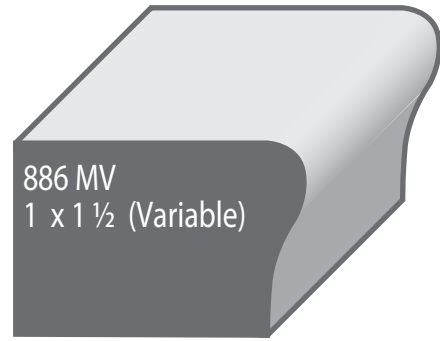
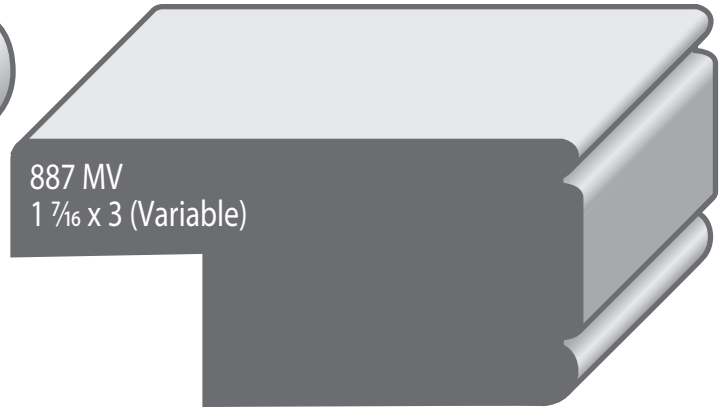
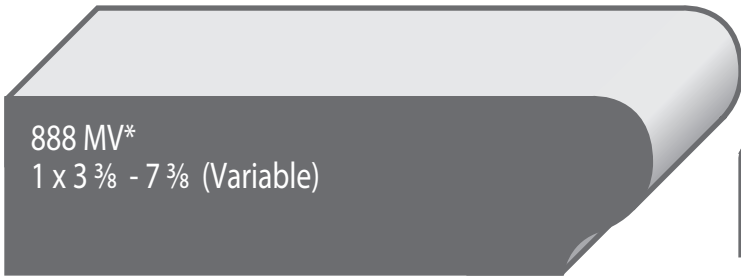



422 S1
 $\frac{3}{4} \times 1 \frac{11}{16}$

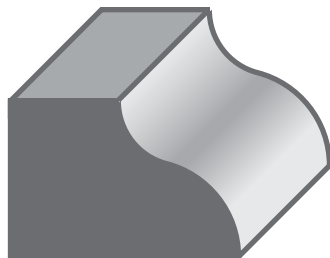

423 S1
 $1 \frac{13}{16} \times 1 \frac{3}{16}$

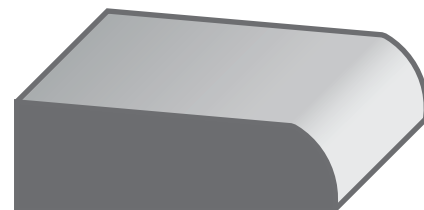

409 S1
 $\frac{9}{16} \times 1 \frac{11}{16}$



415 S1
 $\frac{1}{2} \times 1 \frac{1}{2}$

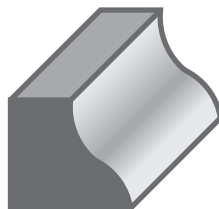

419 S1
 $\frac{9}{16} \times \frac{5}{8}$

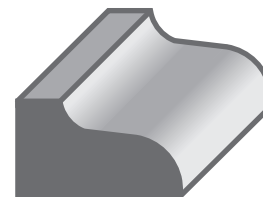

424 S1
 $\frac{1}{2} \times \frac{7}{8}$



420 S1*
 $\frac{3}{8} \times 1 \frac{9}{16}$



417 S1*
 $\frac{3}{8} \times \frac{7}{8}$

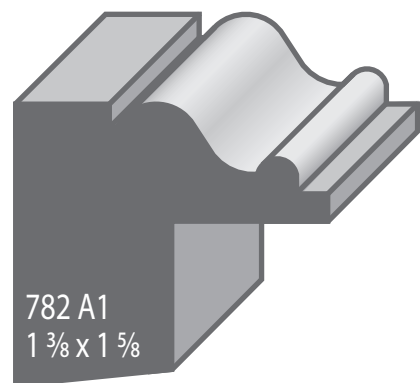

782 A1
 $1 \frac{3}{8} \times 1 \frac{5}{8}$

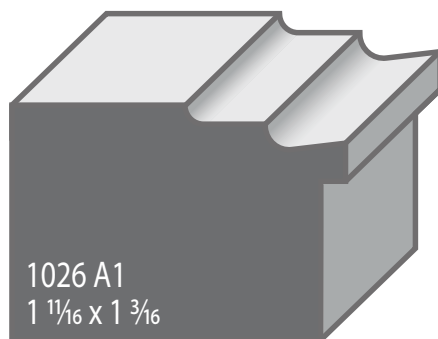

1026 A1
 $1 \frac{11}{16} \times 1 \frac{3}{16}$

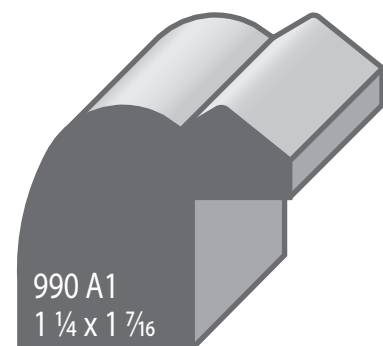

990 A1
 $1 \frac{1}{4} \times 1 \frac{7}{16}$

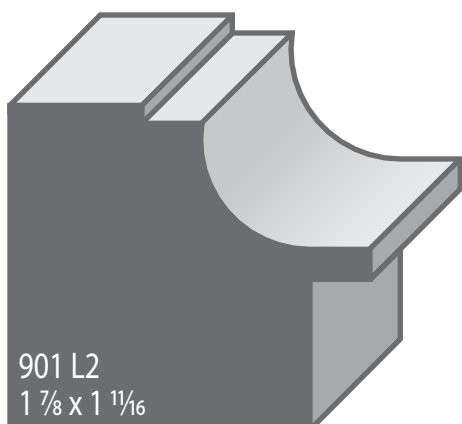

901 L2
 $1 \frac{7}{8} \times 1 \frac{11}{16}$

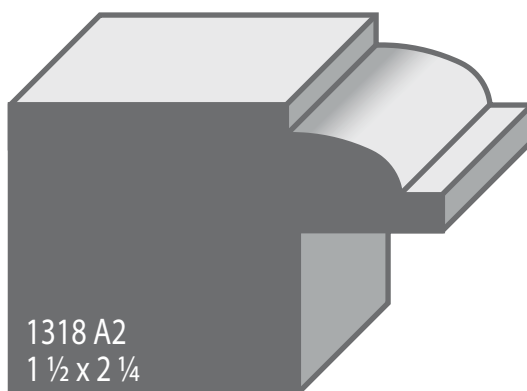

1318 A2
 $1 \frac{1}{2} \times 2 \frac{1}{4}$

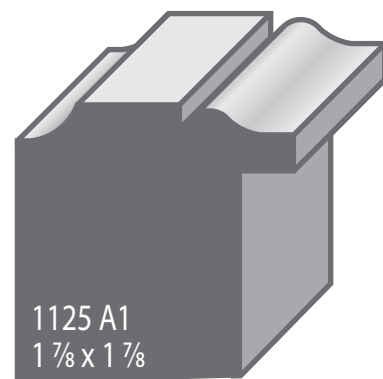

1125 A1
 $1 \frac{7}{8} \times 1 \frac{7}{8}$

