

Section B - Casings

McCOY MILLWORK

Custom Shop Services

For custom profiles pricing is determined by the chosen species of wood and quantity. Provide the following:

1. A sample or scale drawing of the profile.
2. Amount of moulding needed in Lineal Feet.
3. Preferred species of wood.
4. Preferred final finish (paint or stain).

Send us your information via email or come in for a quote. You can expect to hear from us regarding pricing in 2 days.

Manufacturing time varies: 2 days-2 weeks.

Profile #	Pg #	Profile #	Pg #	Profile #	Pg #	Profile #	Pg #
001-T2 Fluted Casing	81	120-T2 Casing	66	170C-T2 Casing	51	264-T2 Casing	67
010-T2* Fluted Casing	81	121-T2 Casing	65	170-T2 Casing	51	265-T2* Clamshell Casing	72
011-T2 Fluted Casing	81	122-T2 Casing	67	171B-T2 Center Bead Casing	47	266-T2 Casing	67
012-T2 Fluted Casing	81	130-T2* Casing	71	171-T2 Center Bead Casing	47	268B-T2 Clamshell Casing	72
013-T2 Fluted Casing	81	‡ 133-T2 San Casing	71	172-T2 Casing	66	268-T2 Clamshell Casing	72
014-T2 Fluted Casing	81	134-T2* Casing	65	173B-T2 Casing	46	269-M2 Apron	88
015-T2 Fluted Casing	81	137-T2 Casing	70	173-T2 Casing	46	304-A2 Backband	93
021-T2 Reeded Casing	80	138-T4 Casing	57	174B-T2 Center Bead Casing	47	319-M1 Apron	88
022-T2 Casing	67	139-T2 Casing	67	174-T2 Center Bead Casing	47	355-T2 Casing	52
023-T4 Sym Casing	73	140-T2* Casing	49	175-T2 Casing	66	356-T2* Casing	52
024-T4 Sym Casing	75	141-T2 Casing	49, 69	176-T2 Casing	63	357-T2 Casing	53
025-T2 Reeded Casing	80	142-T2 Casing	69	177B-T3 Casing	58	358B-T2 Col Casing	52
026-T1 Reeded Casing	80	143-T2 Casing	49	177-T3 Casing	60	358-T2 Casing	53
027-T2 Reeded Casing	80	‡ 144-T2 Casing	69	178-T2 Casing	79	359-T2 Casing	52
028-T2 Sym Casing	80	145-T3 Casing	64	178-T3 Sym Casing	77	‡ 384-BV Apron	88
029-T2 Sym Casing	78	148-T2 Casing	62	179-T3 Sym Casing	76	386-T3 Casing	59
030-T2 Fluted Casing	81	149B-T2 Casing	65	180-T4* Sym Casing	74	387-MV Casing	65
031-T3 Sym Casing	77	149-T2 Casing	63	‡ 181B-T4 Sym Casing	73	387-T2 Casing	65
100-T1* Sym Casing	79	150B-T2 Casing	48	181-D4 Sym Casing	74	388B-T2 Casing	54
107-T1 Casing	71	150C-T2 Casing	49	181-T4 Sym Casing	75	388C-T2 Casing	54
108-T1 Casing	71	150F-T2 Ogee Casing	48	183-T3 Sym Casing	76	388D-T2 Casing	54
109-T1 Casing	71	150-T2* Casing	49	185B-T2 Sym Casing	68	388-T2 Casing	54
110-T1* Casing	71	151-T3 Casing	57	185-T2* Casing	65	390-T2 Casing	54
‡ 111B-T2 Cntr Bd Casing	47	152-T3 Casing	57	187-D2 Sym Casing	79	391-T1 Casing	70
111C-T2 Center Bead Casing	47	153-M2 Apron	87	191-T2 Casing	53	392.2-T2 Step Casing	54
111-T2* Center Bead Casing	47	153-T3 Casing	57	193-T2 Casing	68	392-T2 Step Casing	54
112-T1* Casing	70	155-T3* Casing	60	194-T2 Casing	53	409-S1 Stop	91
113B-T3 Casing	53	156-T2 Casing	48	196-T2 Casing	53	410-T2 Casing	68
113-T2* Casing	53	158B-T3 Casing	60	207-T3 Apron/Casing	87	411-T2* Casing	66
114-BV Casing	55	158-T2 Casing	62	245-T2 Casing	66	413-T2 Casing	66
115-T2* Col casing	52	158-T3 Casing	56	248-P2 Casing	70	415-S1 Stop	91
116-T2 Casing	63	158-T4 Casing	55	261-T1 Clamshell Casing	72	416-T3 Casing	57
117-T2 Casing	67	159B-T3 Casing	48	262-T1* Clamshell Casing	72	417-S1* Stop	91
118-T2 Casing	66	159-T3 Casing	48	263-T1 Clamshell Casing	72	418-S1 Stop	91
119-T3 Casing	60	‡ 162-B2 Col Casing	53	263-T2* Clamshell Casing	72	419-S1 Stop	91
120-M4 Apron	87	170B-T2 Casing	51	264B-T2 Casing	68	420-S1* Stop	91



Profile #	Pg #	Profile #	Pg #	Profile #	Pg #	Profile #	Pg #
421-S1 Stop 91		885-MV Sill 91		1024-A1 Backband 94		1154-T2 Casing 61	
‡ 422-S1 Stop 91		886-MV Sill 91		1025-A1* Backband 93		1156-T2 Casing 64	
423-S1 Stop 91		887-MV Sill 91		1026-A1 Backband 92		1157-T2 Casing 63	
424-P2 Misc/Apron 88		888-MV* Sill 91		1027-A1 Backband 93		1158-T2 Casing 62	
424-S1 Stop 91		889-MV Sill 91		1028-P2 Backband 94		1159-T2 Casing 64	
427-P2 Apron 88		894-D2 Sym Casing 78		1029-A1* Backband 94		1170B-T2 Center Bead Casing 47	
436-P1 Apron 88		899-L2 Lintel 85		1039-T2 Casing 69		1170-T2 Center Bead Casing 47	
444-T2* Casing 52		900-L2 Lintel 83		1104-T2 Casing 69		1171-T2 Center Bead Casing 47	
447-T2 Casing 52		901-A2 Backband 92		1105-T2 Casing 69		1172-T2 Center Bead Casing 47	
448-T2 Casing 52		902-L2 Lintel 82		1111B-T2 Center Bead Casing 46		1173B-T2 Center Bead Casing 47	
487-T2 Casing 66		903-L2 Lintel 83		1111-T2 Center Bead Casing 46		1173-T2 Center Bead Casing 47	
488-T2 Casing 54		904-L2 Lintel 84		1113-T2 Casing 53		1174-T2 Casing 68	
496-T3 Casing 58		905-L2 Lintel 83		1114-T3 Casing 53		1175-T2 Center Bead Casing 47	
503-S1* Parting Bead 86		906-L2 Lintel 83		1117-T2 Reeded Casing 80		1176-T2 Center Bead Casing 46	
504-L2* Lintel 84		907-L2 Lintel 85		1118-T2 Casing 49		1177-T2 Center Bead Casing 46	
525-T4 Sym Casing 74		908-L2 Lintel 83		1120-T2 Casing 69		1181-T4 Sym Casing 73	
528-PV Apron 88		‡ 909-L2 Lintel 85, 86		1121-T2 Casing 65		1182-T4 Sym Casing 74	
529-T2 Sym Casing 78		909-M1 Apron 89		1122-T2 Casing 66		1183B-T4 Sym Casing 74	
530-T2 Sym Casing 79		910-L2* Lintel 84		1123-A1 Backband 93		1183-T3 Sym Casing 76	
533B-T2 Casing 49		911-L2* Lintel 84		1123-T2 Casing 66		1183-T4 Sym Casing 75	
533-T2 Casing 49		912-L2* Lintel 84		1124-T2 Casing 64		1184-T3 Sym Casing 77	
534-T2 Casing 65		913-L2 Lintel 82		1125-A1 Backband 93		1188-T4 Sym Casing 73	
534-T3 Casing 58		914-L2 Lintel 83		1126-A1 Backband 93		1193-T2 Casing 68	
535-T2* Casing 64		915-L3 Lintel 82		1127-A1 Backband 94		1201-BV Casing/Base 49	
536-T3 Casing 59		916-L2 Lintel 85		1128-A1 Backband 93		1203-T2 Casing 69	
‡ 547-L2 Lintel 83, 85, 86		917-L2 Lintel 83		1129-P1 Backband 94		1211-T4 Casing 55	
620-T2 Casing 67		919-L2 Lintel 85		1130-T2 Casing 71		1212-T4 Casing 55	
717-D2 Apron 64		921-L2 Lintel 85		1131-T1 Casing 71		1213-T3 Casing 59	
726-P2 Apron 88		922-L2 Lintel 85		1132-T2 San Casing 71		1214-T4 Casing 55	
‡ 746-P2 Casing 65, 67		929-L2 Lintel 84		1133-T2 San Casing 71		1216-T3 Casing 58	
750-T2 Casing 66		930-L2 Lintel 84		1136-A1 Backband 92		1261-T1 Clamshell Casing 72	
751-MV Apron 88		931-M2 Apron 88		1137-T4 Casing 48		1262-T1 Clamshell Casing 72	
753-D4 Architrave 90		948-S1 Parting Bead 86		1138-T3 Casing 58		1264-T2 Clamshell Casing 72	
755-T2 Casing 66		949-S1 Parting Bead 86		1139-T2 Casing 62		1266-T2 Casing 69	
756-T2 Casing 61		950-S1* Parting Bead 86		1139-T3 Casing 56		1270-T2 Casing 51	
757-T4 Casing 55		953-S1* Parting Bead 86		‡ 1139-TV Casing 63		1318-A2 Backband 92	
758-T3 Casing 57		954-M1 Parting Bead 86		1140-T2 Casing 49		1318B-A2-1 Backband 92	
770-M3 Apron 87		955-S1* Parting Bead 86		1141-T2 Casing 69		1319-M1 Apron 88	
772-M4 Apron 87		956-S1 Parting Bead 86		1142-T2 Casing 68		1381-T3 Casing 60	
781-P2 Casing 67		957-S1* Parting Bead 86		1143-T2 Casing 67		1384-T2 Casing 54	
782-A1 Backband 92		984-A1 Backband 93		1145-T2 Casing 66		1438-T2 Col Casing 52	
803-T2 Sym Casing 79		985-A1 Backband 93		1146-T2 Casing 67		1439-T2 Col Casing 52	
804-T3 Sym Casing 77		990-A1 Backband 93		1148-T2 Casing 68		1444-T3 Casing 52	
806-T2 Casing 68		994-T2 Casing 64		1149-T2 Casing 67		1460-T2 Casing 69	
807-P2 Apron 88		1001-T4 Fluted Casing 81		1150-T2 Casing 48		1461-T2 Casing 66	
808-T2 Casing 69		1020-A1 Backband 93		1151-T2 Casing 48		‡ 1462-T2 Casing 65	
820-T2 Symm Casing 79		1021-A1* Backband 93		1152-T2 Casing 63		1463-T2 Casing 51	
821-T2 Casing 62		1022-A1* Backband 93		1153-T2 Casing 63		1464-T2 Apron/Misc 88	



Profile #	Pg #	Profile #	Pg #	Profile #	Pg #	Profile #	Pg #
1467-T2 Casing	65	2136-T2 Casing	51	2815-T2 Sym Casing	79		
1504-L2 Lintel	84	2138-T3 Casing	50	2817-T2 Sym Casing	78		
1507-L2 Lintel	86	2139-A0 Backband	92	2833-T2 Step Casing	54		
1509-L2 Lintel	85	2141-T2 Base	68	2870-T3 Casing	59		
1521-T2 Sym Casing	81	2150-T2 Ogee Casing	49	2877-T3 Casing	58		
1523-T2 Sym Casing	79	2151-T2 Casing	64	2878-A1 Backband	92		
1524-T2 Reeded Casing	80	2156-T2 Sym Casing	78	2913-L1 Lintel	86		
1526-T2 Sym Casing	78	2173-T2 Center Bead Casing	46	2923-A1 Backband	92		
1527-T3 Sym Casing	73	2175-T2 Casing	61	2948-S1 Parting Bead	86		
1528-T4 Sym Casing	73	2178-T3 Symm Casing	78	2950-M1 Parting Bead	86		
1529-T4 Sym Casing	73	2178-T4 Sym Casing	75	2951-M1 Parting Bead	86		
1530-T2 Casing	61	2180-T4 Sym Casing	73	2953-S1 Parting Bead	86		
1531B-T4 Sym Casing	78	2182-T3 Sym Casing	76	2955-S1 Parting Bead	86		
‡ 1531-T4 Sym Casing	75	2183-T4 Symm casing	74	3029-A2 Backband	94		
1532-T3 Sym Casing	77	2184-T4 Symm Casing	74	3120-T2 Casing	61		
1560-T3 Casing	60	2186-T4 Sym casing	77	3121-T3 Casing	60		
1561-T2 Casing	62	2190-C2 Casing	67	3122-T2* Casing	50		
1570-T3 Sym Casing	76	2190-T2 Casing	68	3123-T3 Casing	57		
1580-T4 Casing	56	2249-M2 Apron	87	3131-T2 Casing	51		
1701-S1 Stop	91	2264-T2 Casing	72	3133-T2 Casing	62		
1720-T3 Sym Casing	76	2296-D2 Casing	68	3134B-T2 Casing	50		
1804-T2 Casing	70	2316-T3 Casing	58	3134B-T4 Casing	50		
1911-L2 Lintel	84	2318-A1 Backband	92	3134-T4 Casing	50		
1912-L2 Lintel	85	2330-M1 Apron	87	3135-T3 Casing	59		
1913-L2 Lintel	82	2357-T2 Col Casing	52	3136-T4 Casing	56		
1914-L2 Lintel	85	2383-T2 Step casing	54	3137-T4 Casing	61		
1916-L2 Lintel	82	2384-T2 Step Casing	54	3138-T3 Casing	50		
1917B-L1 Lintel	86	2388-T2 Step Casing	54	3176-T2 Casing	64		
‡ 1917-L1 Lintel	86	2390-B3 Casing/Base	59	5100B-H4 Architrave	90		
1919-L2 Lintel	82	2392-T2 Casing	61	5100-H4 Architrave	90		
1920-L2 Lintel	85	2397-T2 Casing	63	93041-A1 Backband	93		
1922-A1 Backband	94	2411-T2 Center Bead Casing	46				
2001-T2 Sym Casing	80	2420-SV Stop	91	C			
2020-T2 Sym Casing	78	2421-S1 Stop	91	CS-DB1 Dentil	89		
2021-T2 Reeded Casing	80	2444-T2 Casing	52	CS-MS1CL Apron	89		
2022-A1 Backband	92	2448-T2 Casing	65	CS-MS2M Apron	89		
2025-T2 Reeded Casing	80	2449-T2 Casing	65	CS-MS3LG Apron	89		
2027-A1 Backband	93	2461-T2 Casing	62	CS-OG1 Ogee	89		
2104-T2 Col Casing	68	2472-T1 Casing	70	CS-OV1 Apron Ovolo	89		
2111-T2 Center Bead Casing	46	2485-T4 Casing	56	CS-SC1 Canted Top Shelf	89		
2112-T2 Beaded Casing	51	2500-A1 Backband	93	CS-SC2 MOULDED SHELF	89		
2116-T2 Casing	63	2509-L2 Lintel	92	CS-SC3 Canted Top Shelf	89		
2118-T2 Casing	49	2528-T2 Casing	67				
2124-T2 Casing	64	2531-T2 Sym Casing	78	S			
2130-T2 Casing	71	2534-T2 Casing	49	SNW-334 Casing	79		
2131-T2 San Casing	71	2536-T2 Apron	87				
2135-T4 Casing	56	2746-T2 Casing/Apron	68				



‡ Sample missing

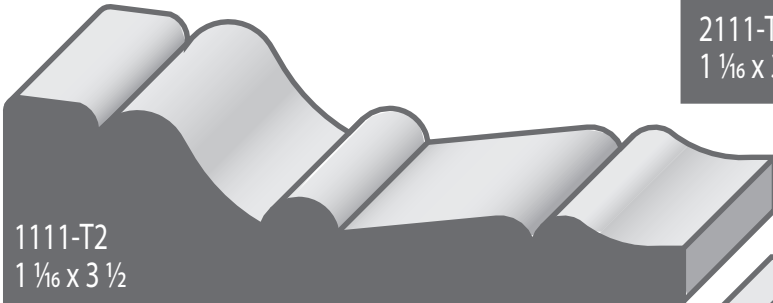

1111-T2
1 1/16 x 3 1/2

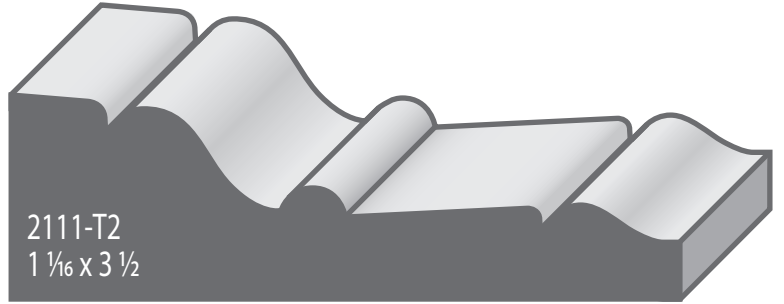

2111-T2
1 1/16 x 3 1/2

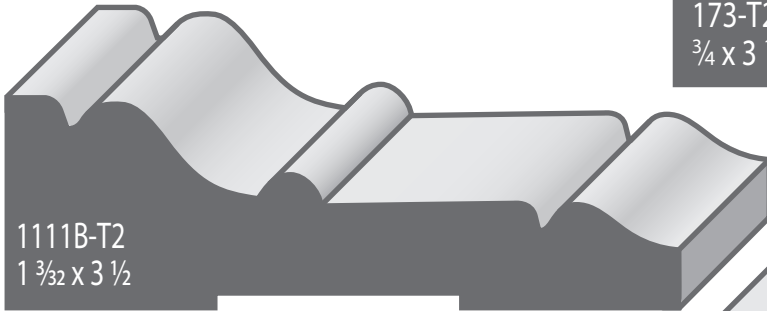

1111B-T2
1 3/32 x 3 1/2

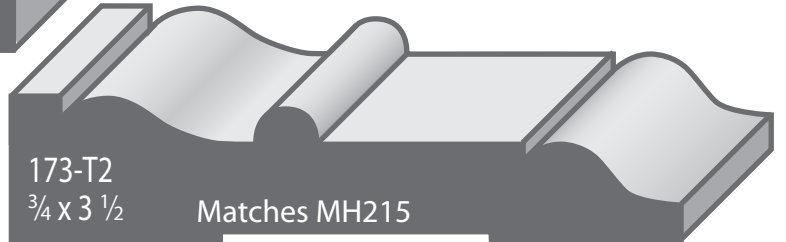

173-T2
3/4 x 3 1/2
Matches MH215

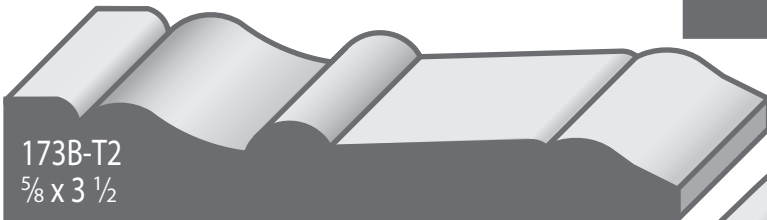

173B-T2
5/8 x 3 1/2



1176-T2
13/16 x 3 1/2

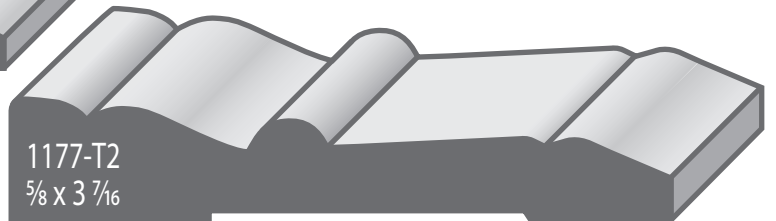

1177-T2
5/8 x 3 7/16

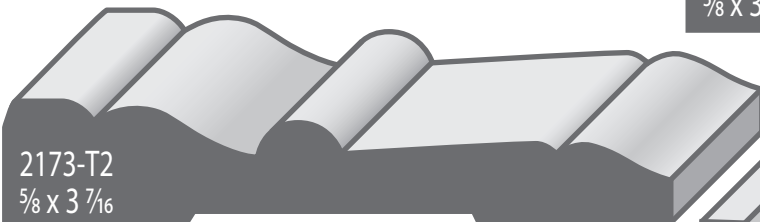

2173-T2
5/8 x 3 7/16

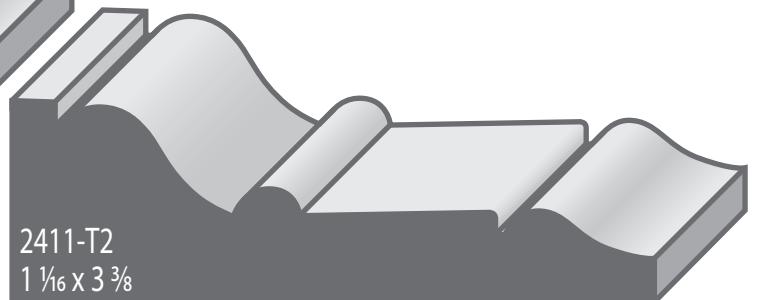

2411-T2
1 1/16 x 3 3/8

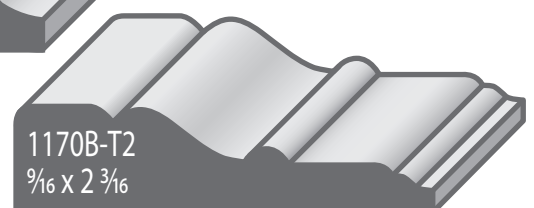
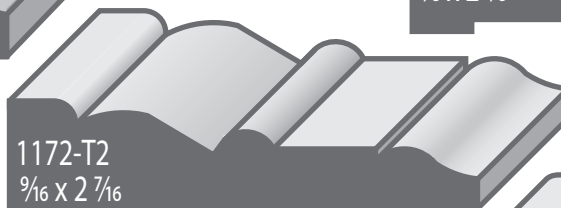
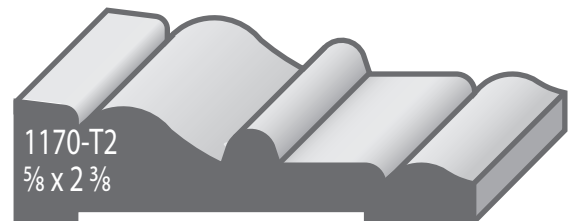
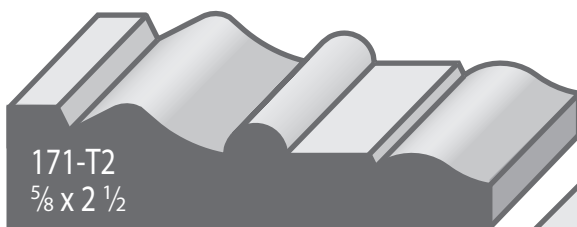
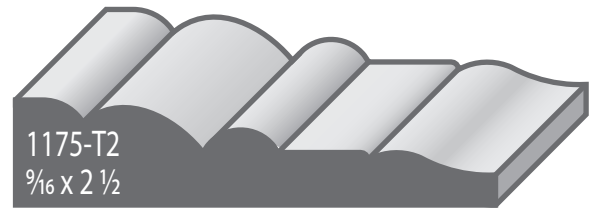
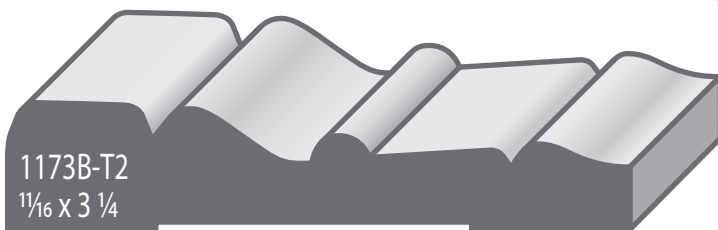
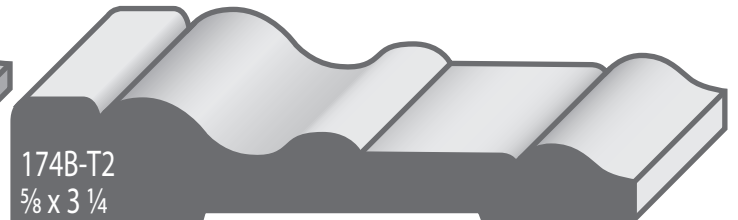
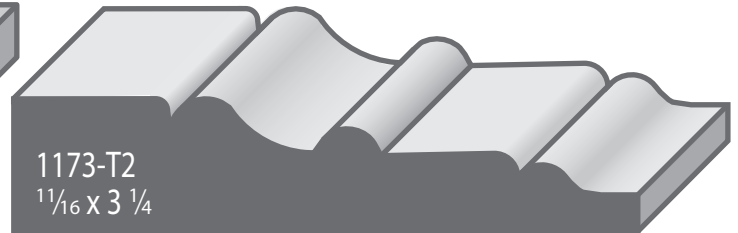
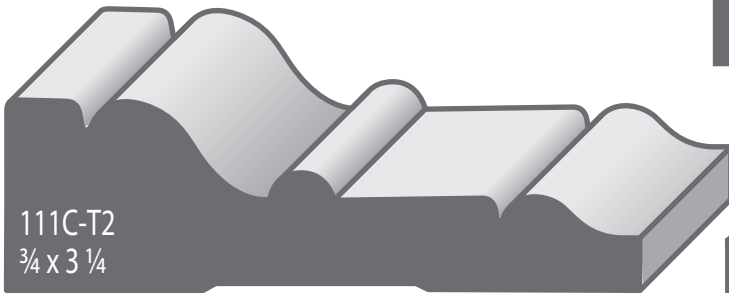
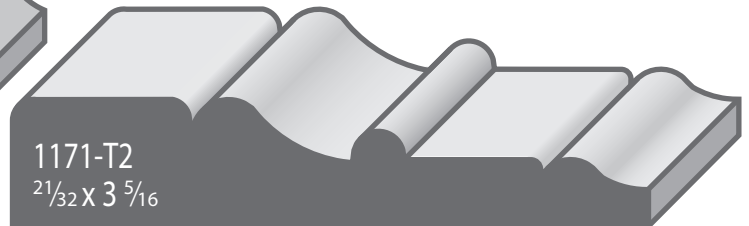
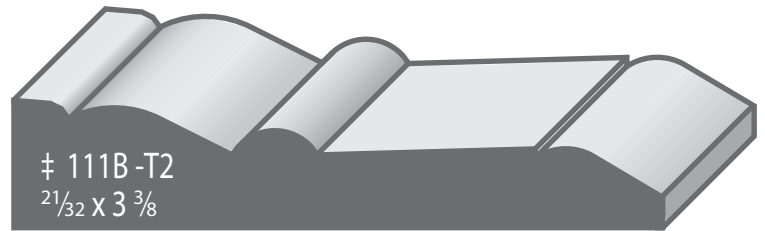
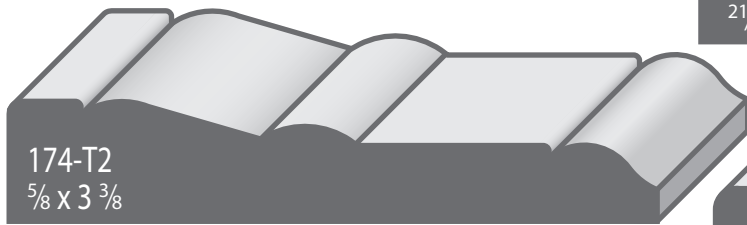

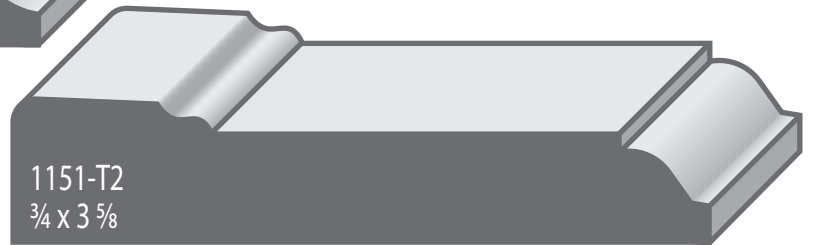
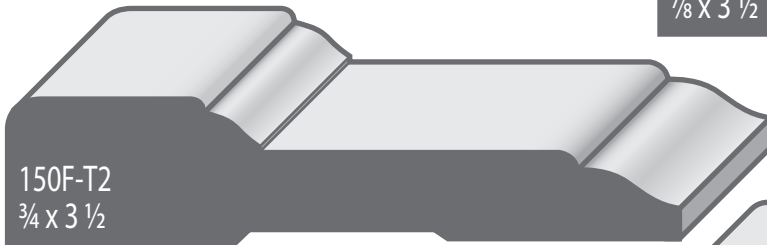
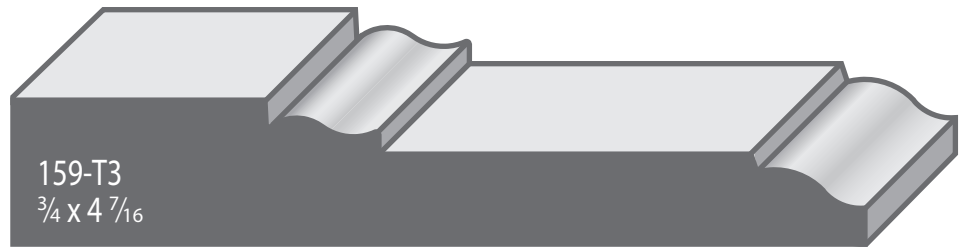
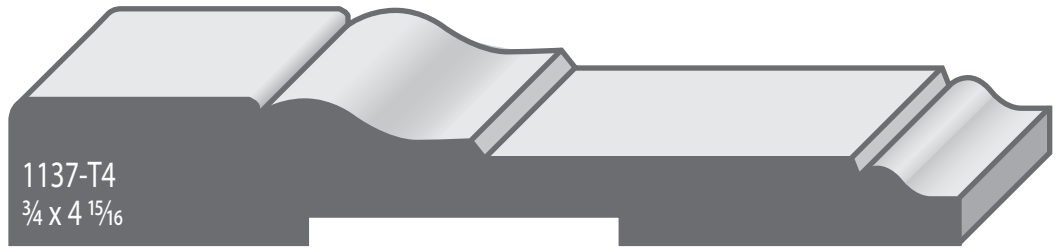

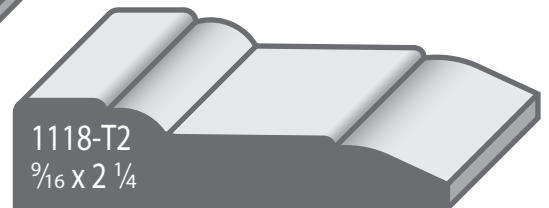
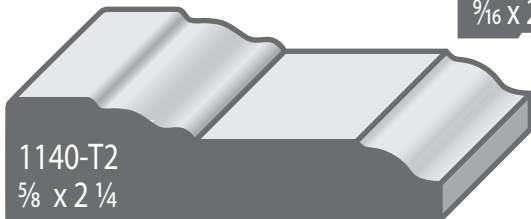
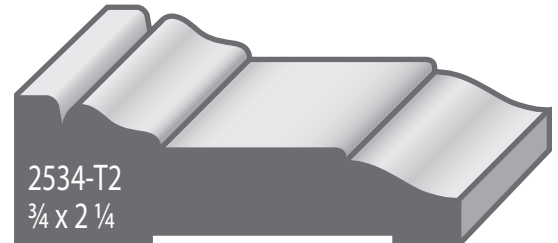
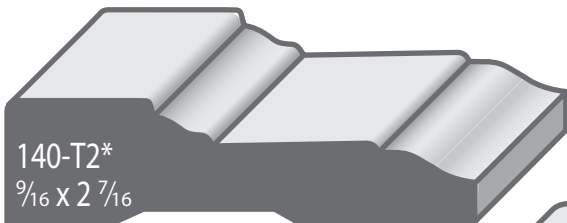
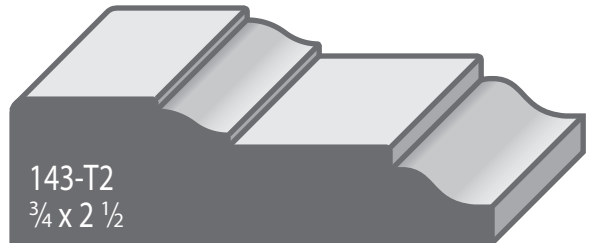
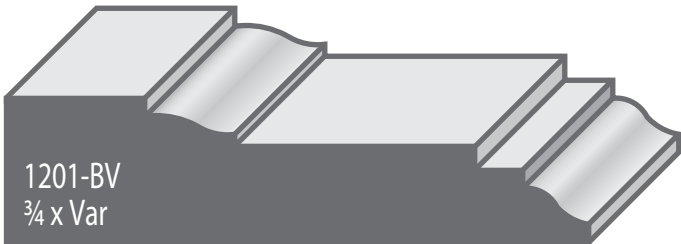
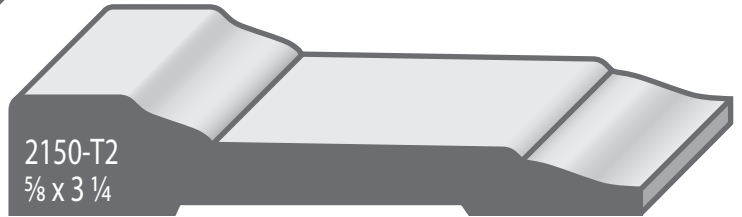
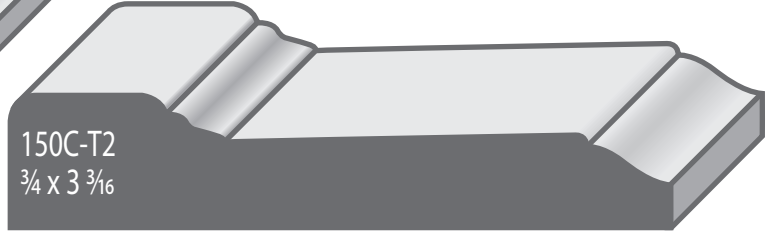
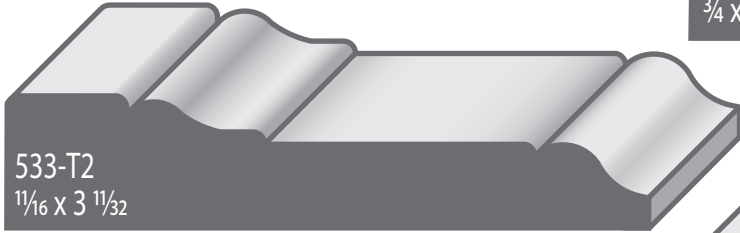

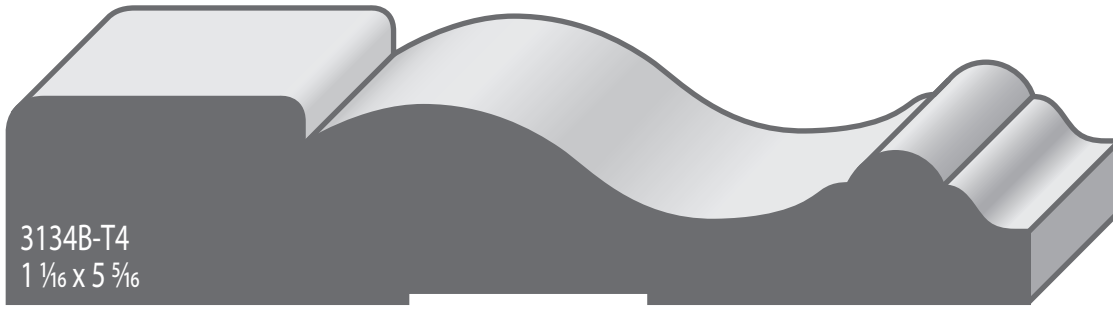

3134B-T4
1 1/16 x 5 5/16

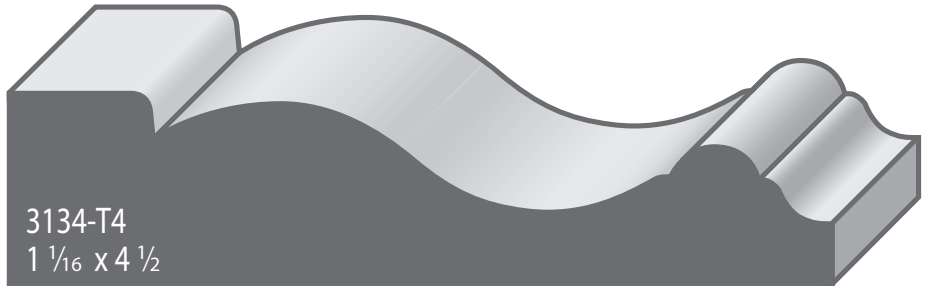

3134-T4
1 1/16 x 4 1/2

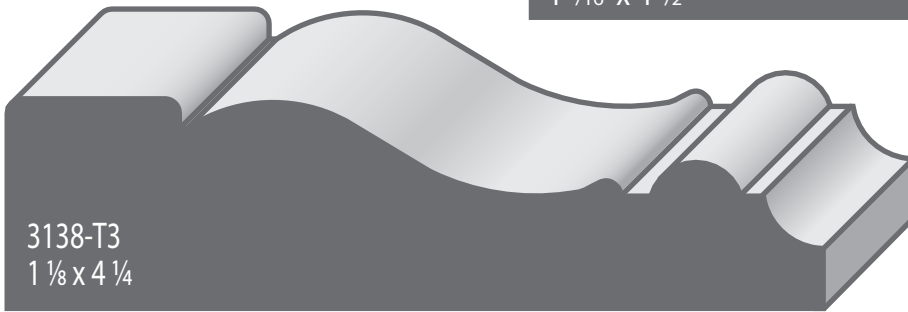

3138-T3
1 1/8 x 4 1/4

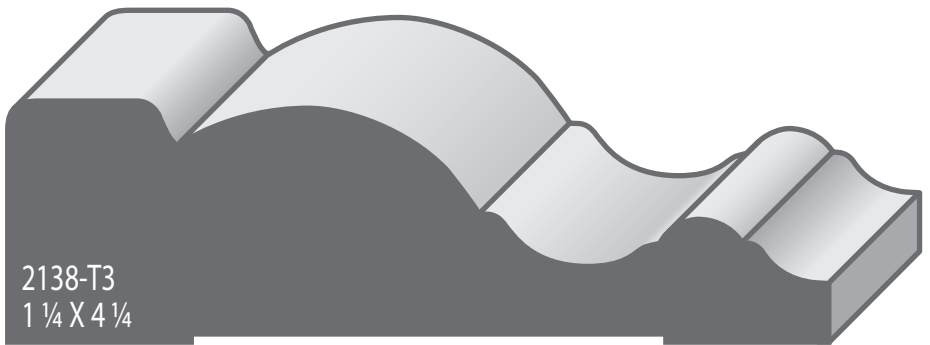

2138-T3
1 1/4 x 4 1/4



3134B-T2
1 x 3 1/2



3122-T2*
1 x 3 1/2

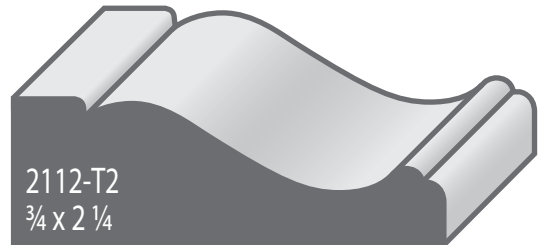
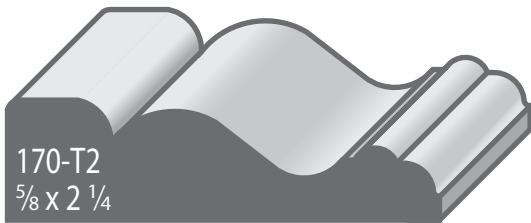
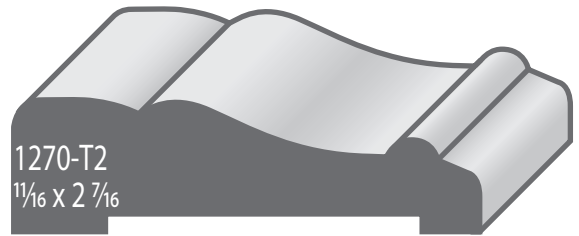
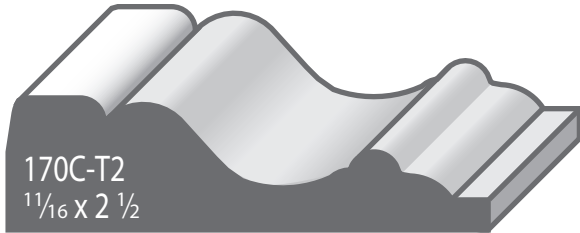
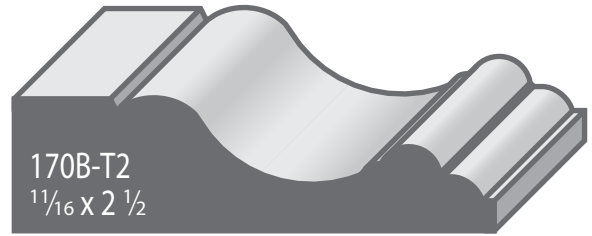
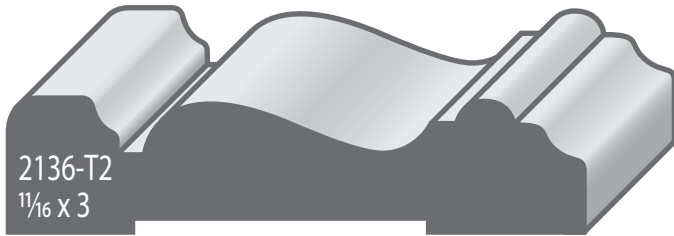
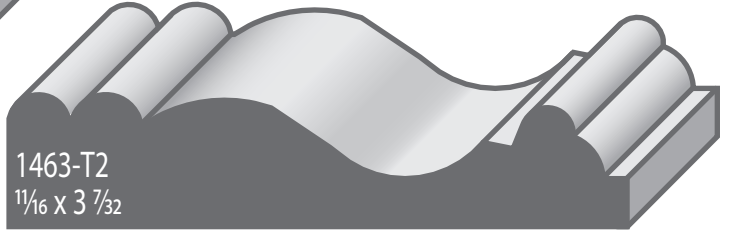

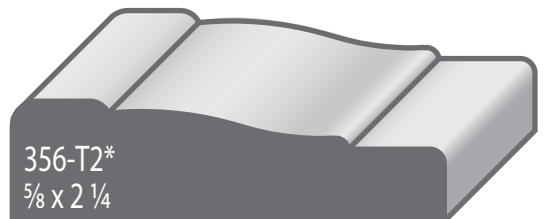
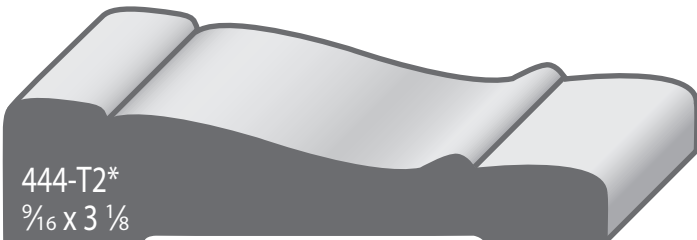
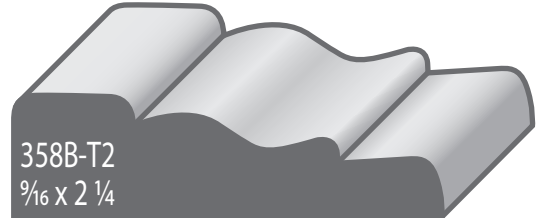
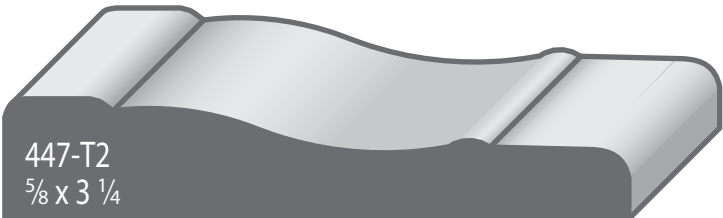
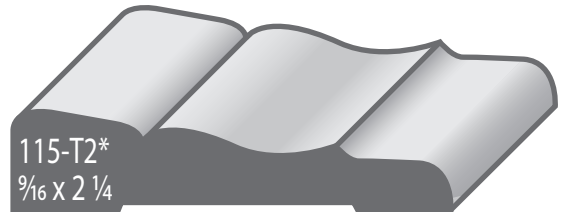
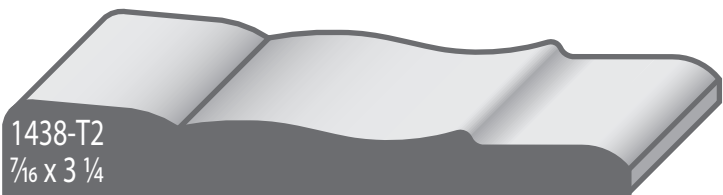
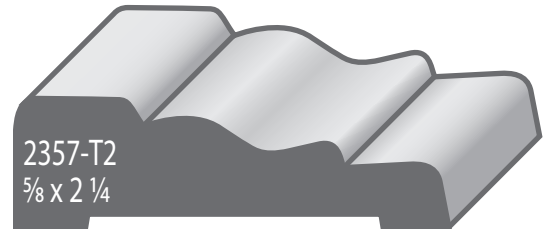
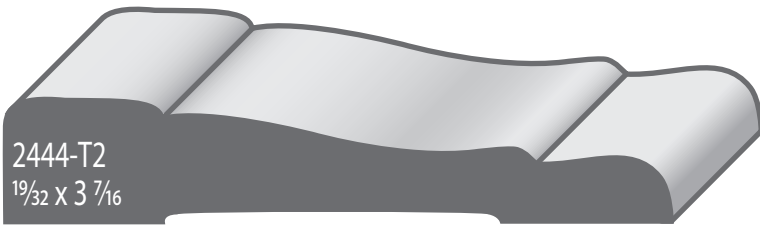
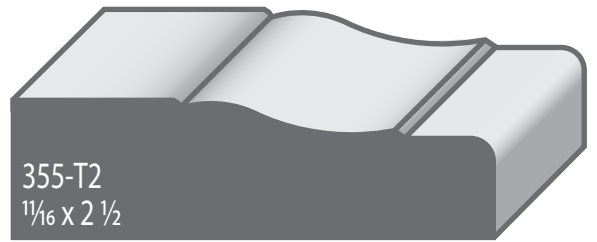
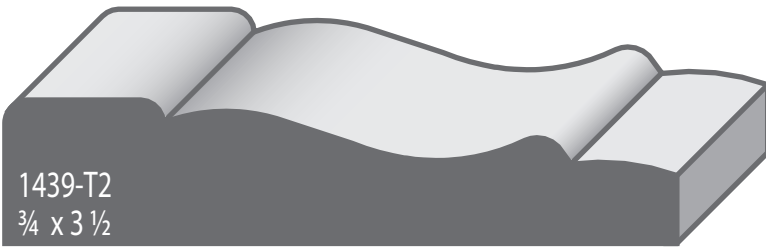
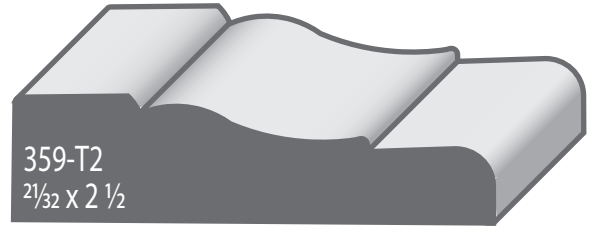
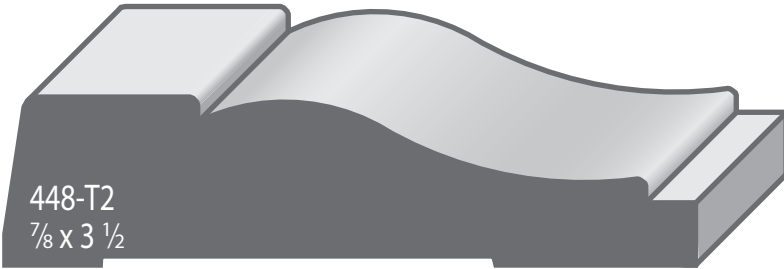
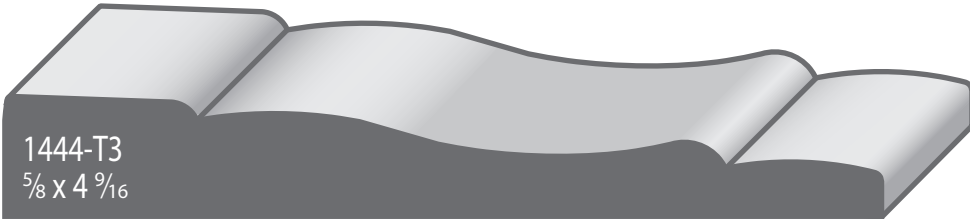



‡ Sample missing

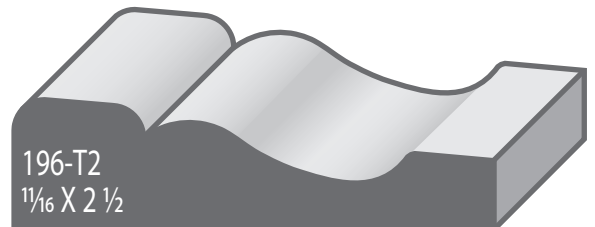
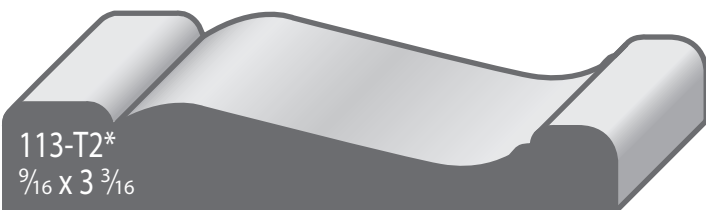
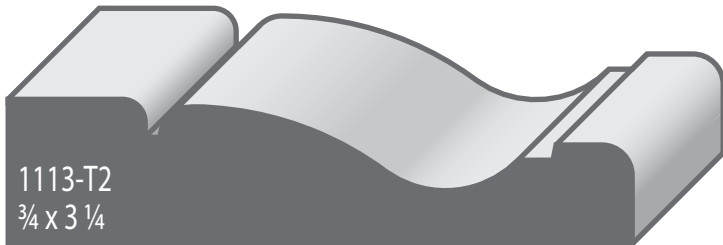
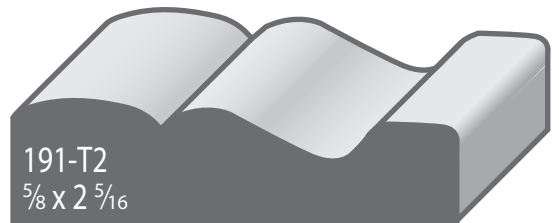
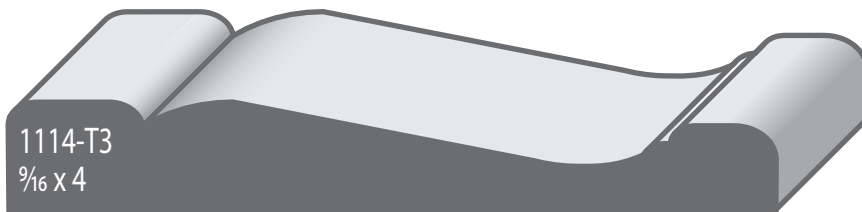
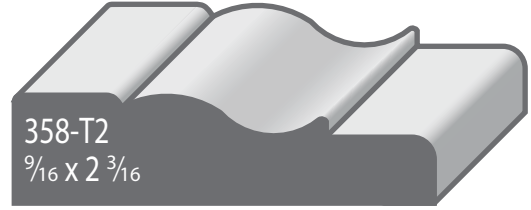
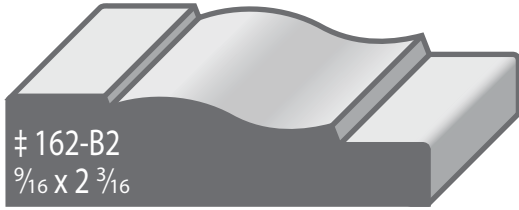

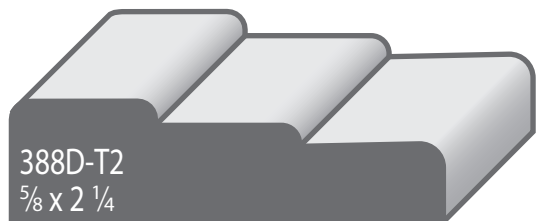
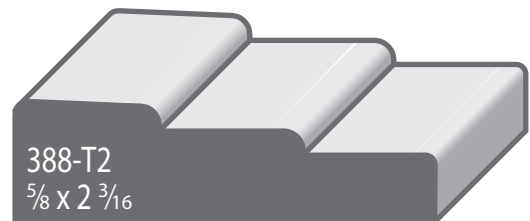
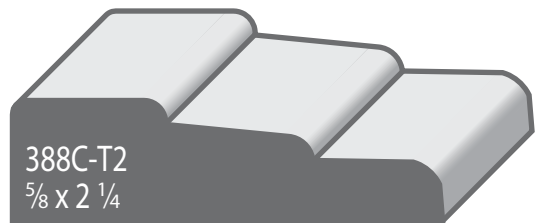
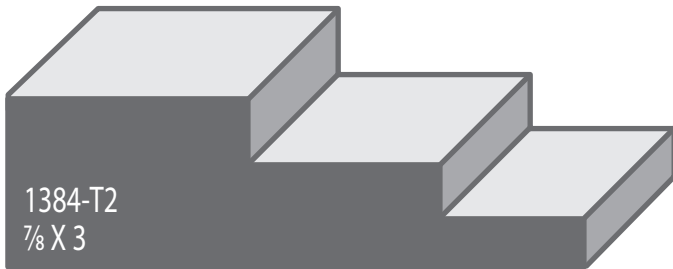
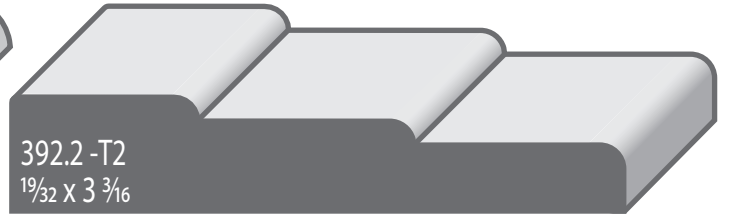
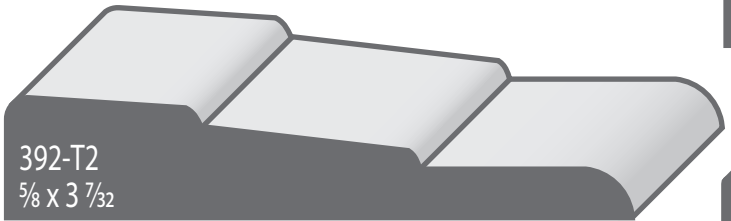
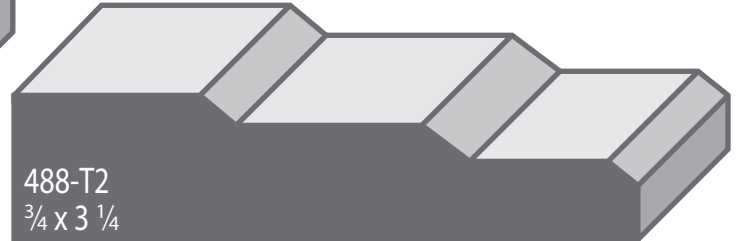
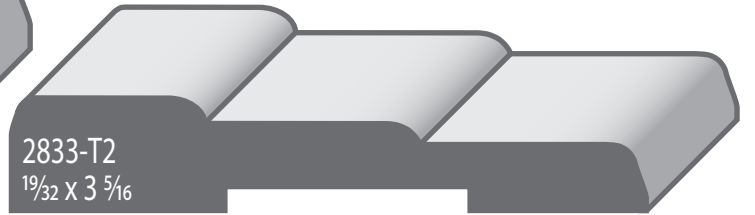
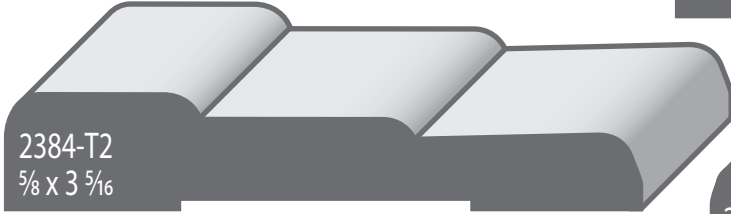
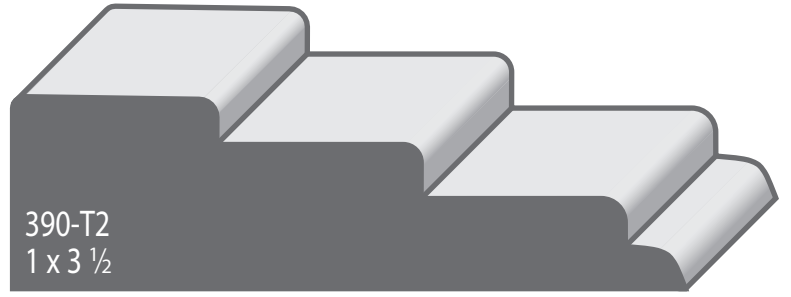

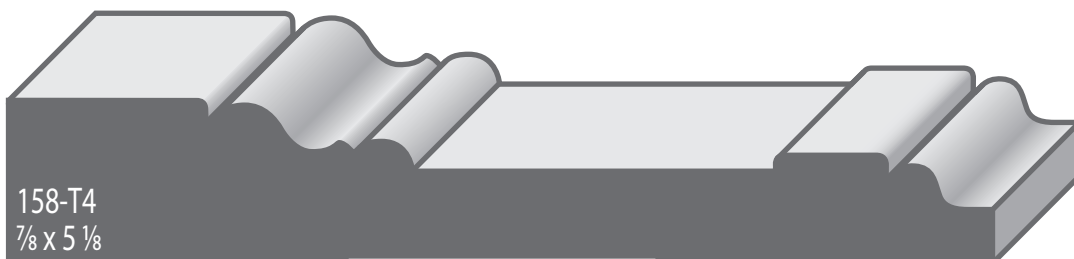
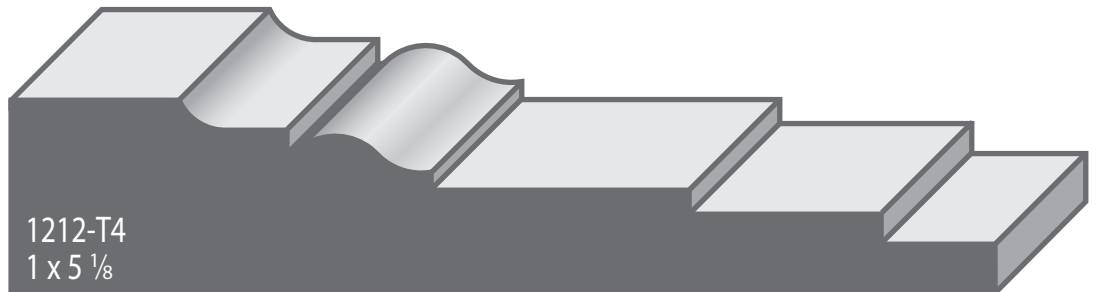
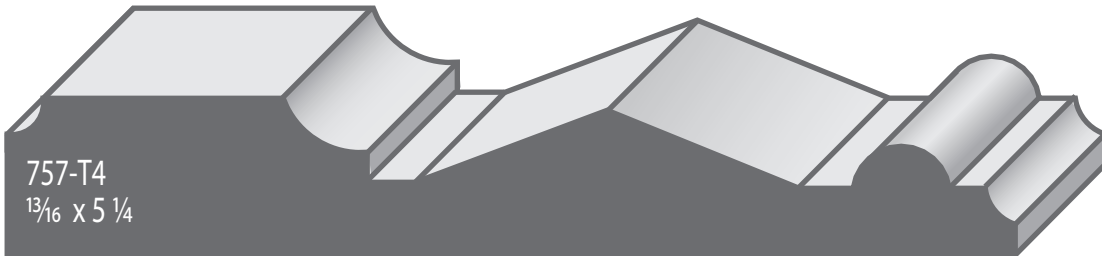
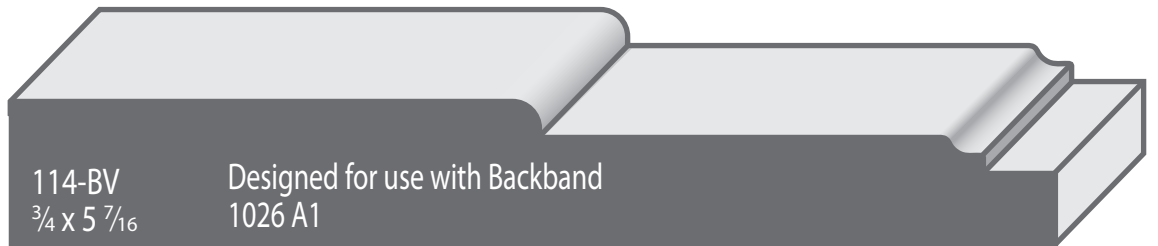
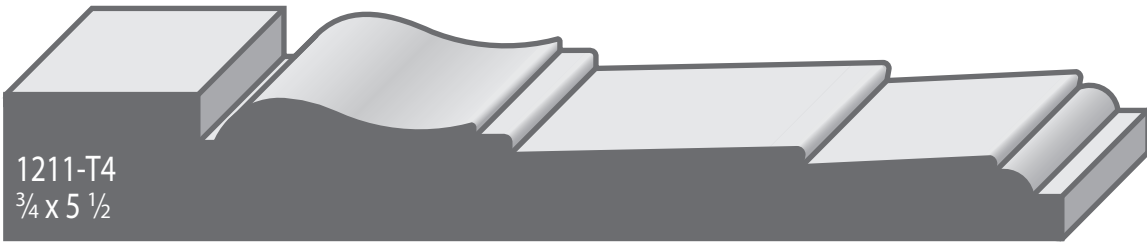
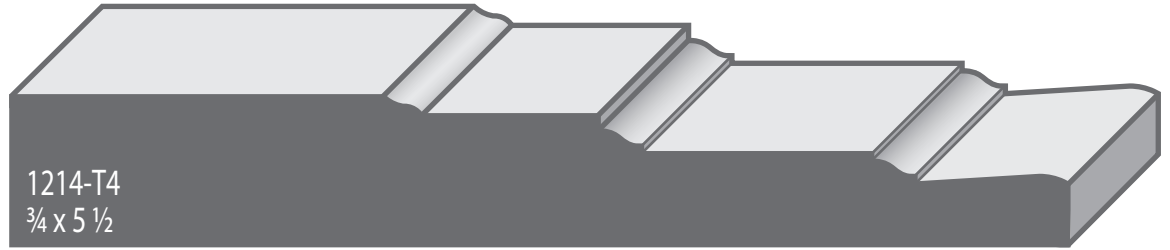

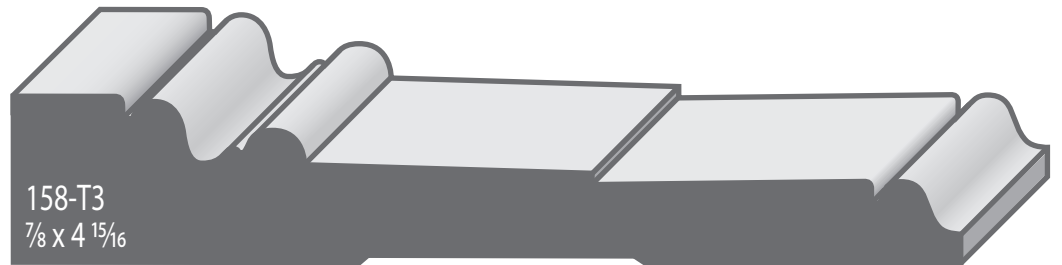
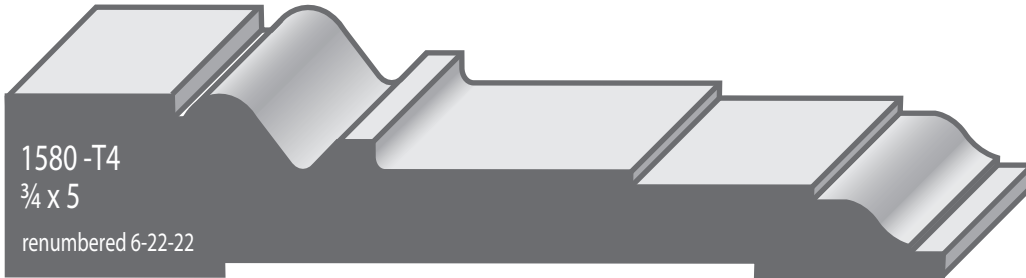
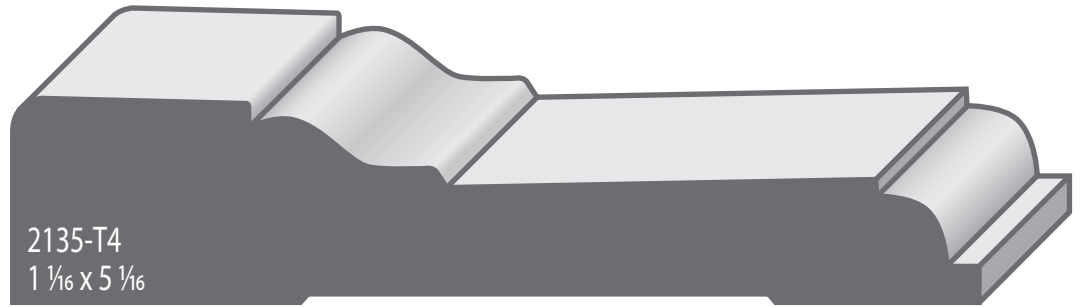

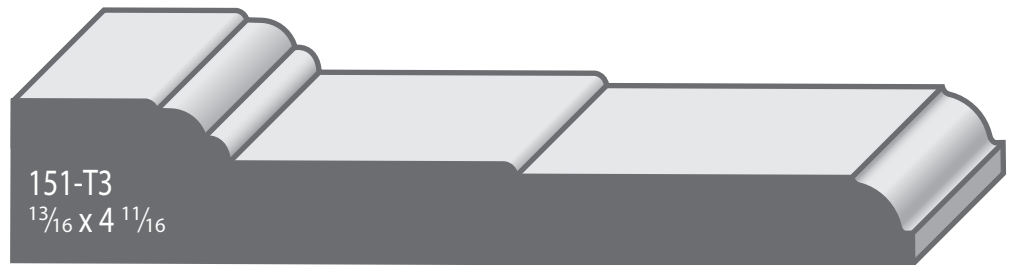
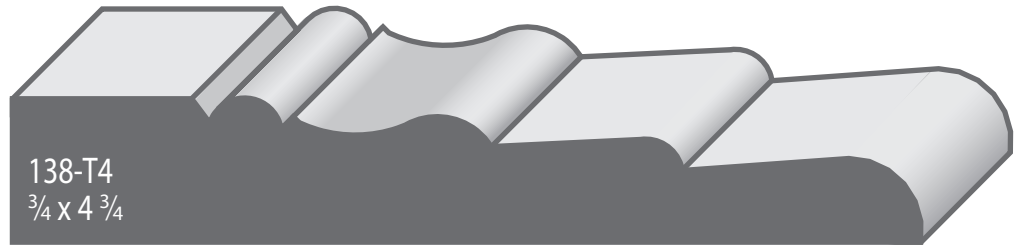
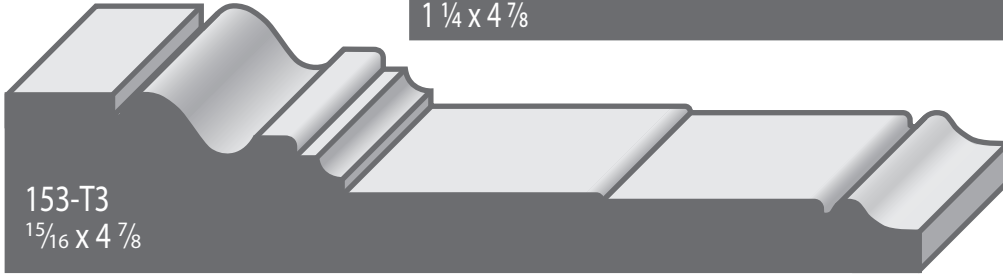
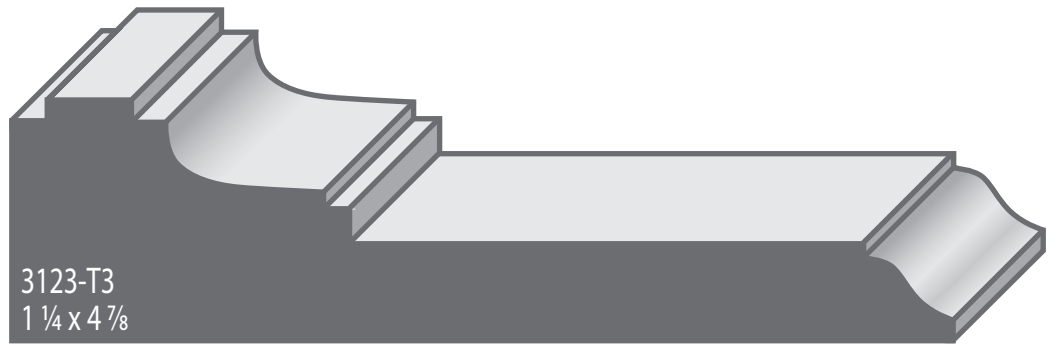

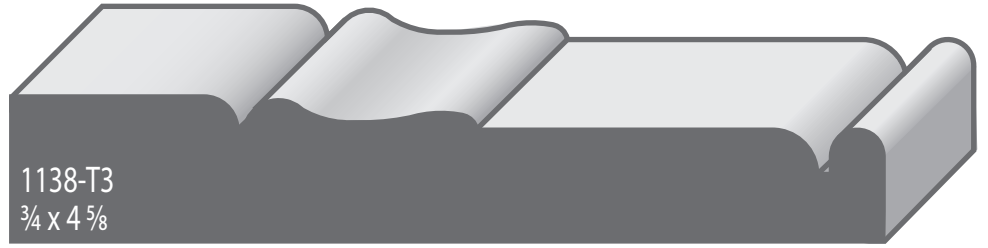

1138-T3
3/4 X 4 5/8



1216-T3
1 3/16 X 4 5/8



496-T3
1 1/16 X 4 5/8

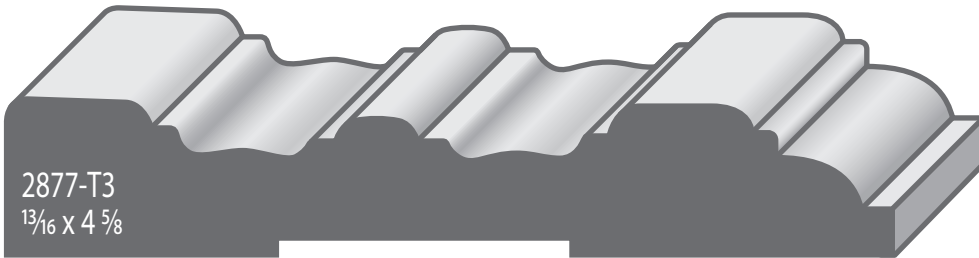

2877-T3
1 3/16 X 4 5/8

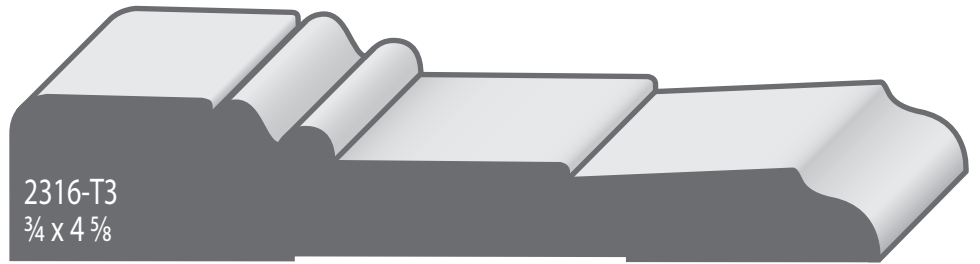

2316-T3
3/4 X 4 5/8



534-T3
27/32 X 4 9/16



177B-T3
3/4 X 4 9/16

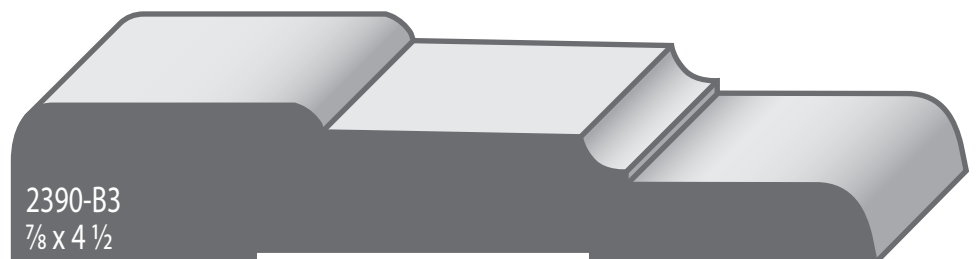
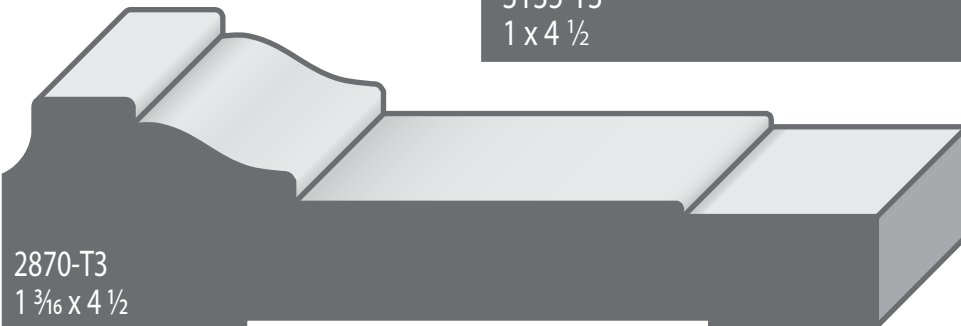
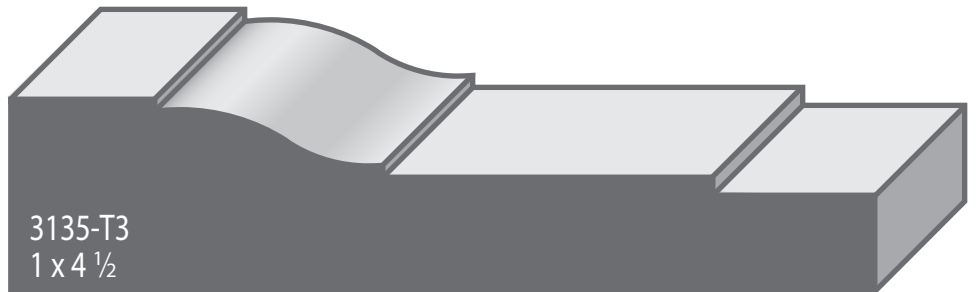
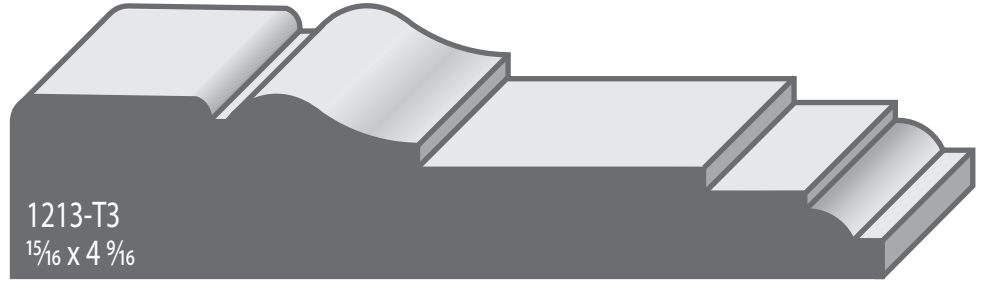
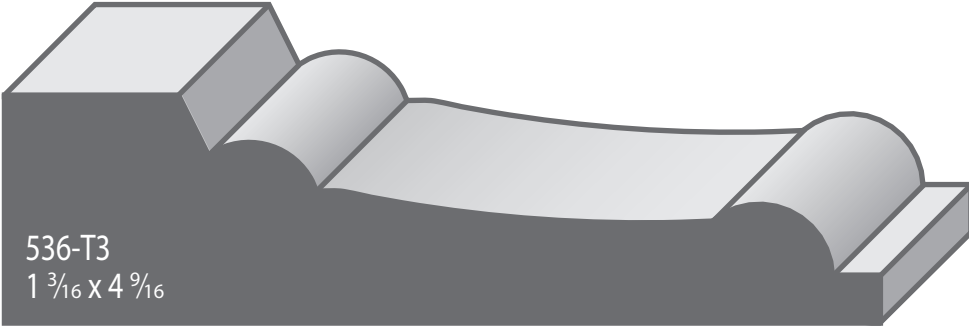

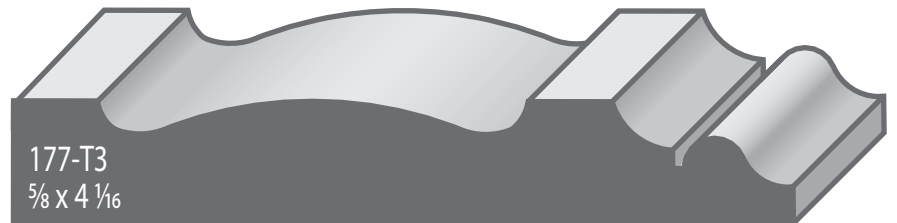
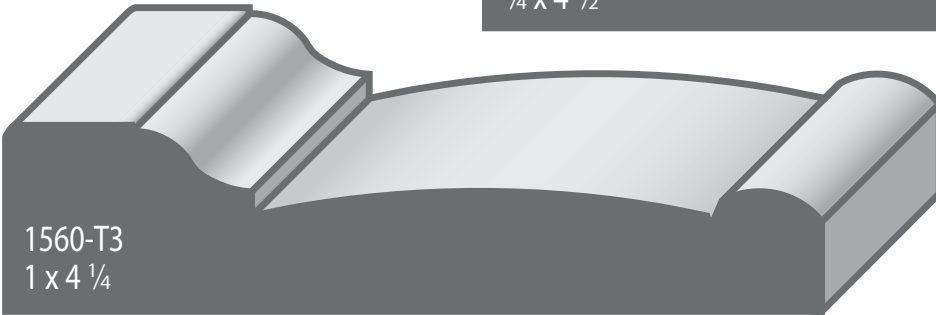
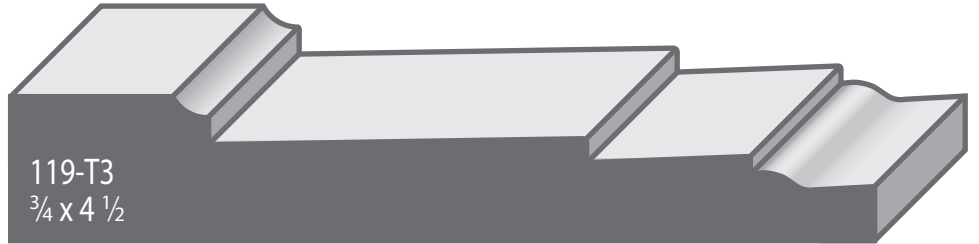
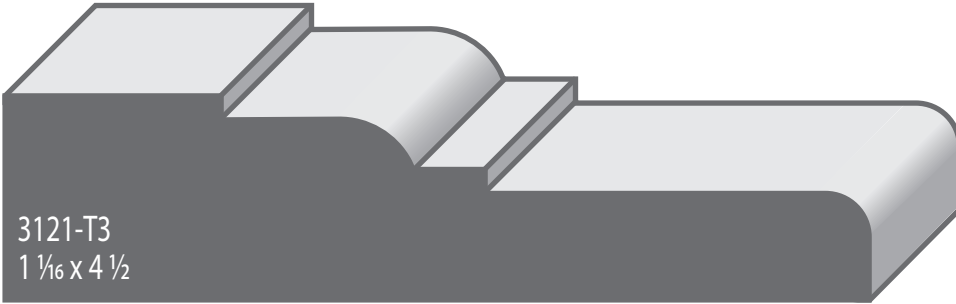

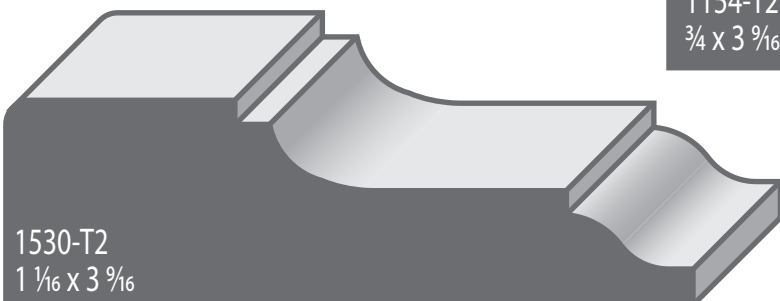
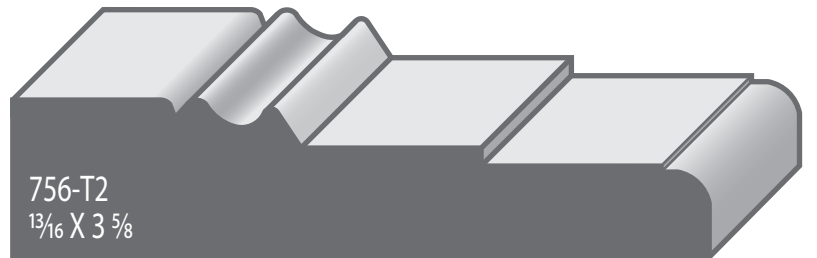
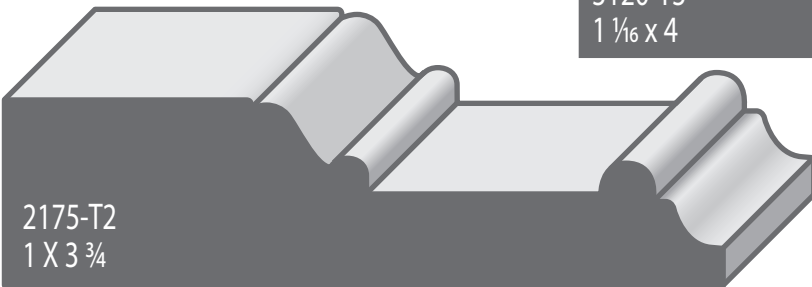
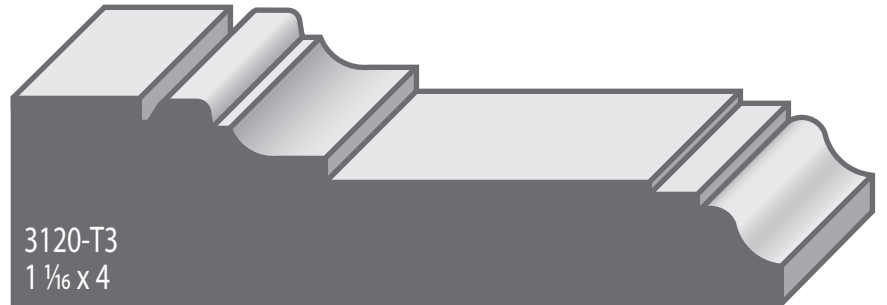
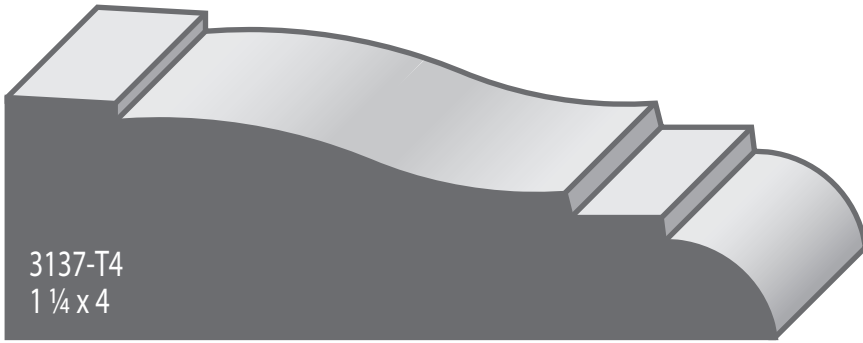



‡ Sample missing

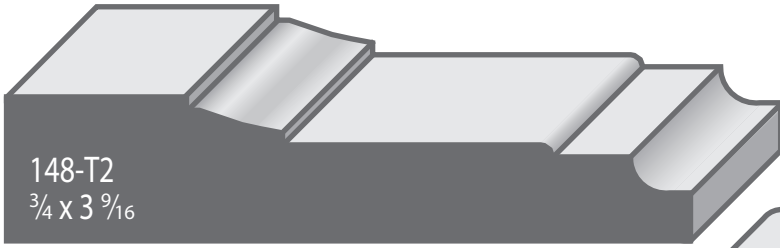

148-T2
3/4 X 3 9/16



1158-T2
3/4 X 3 9/16



1139-T2
3/4 X 3 9/16

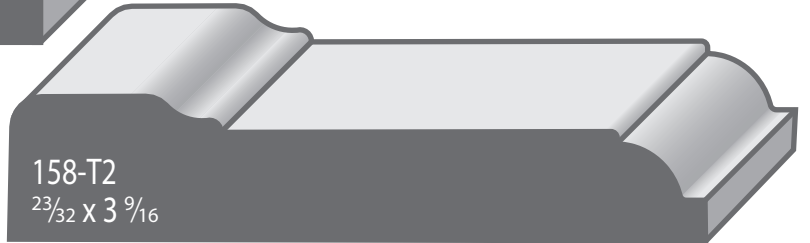

158-T2
23/32 X 3 9/16

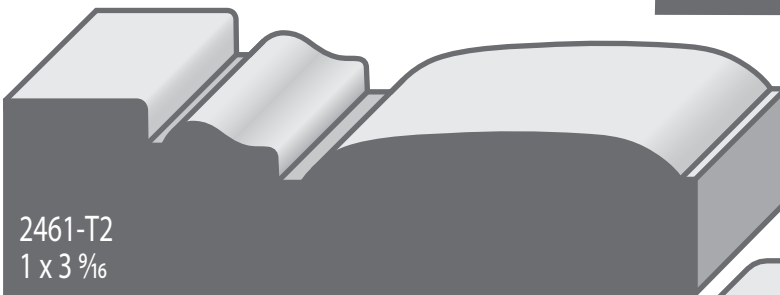

2461-T2
1 X 3 9/16



1561-T2
13/16 X 3 9/16

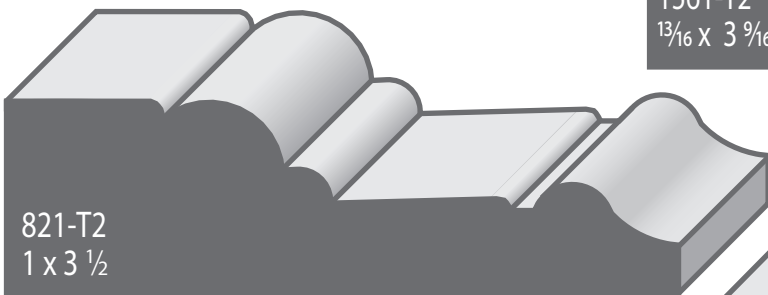

821-T2
1 X 3 1/2

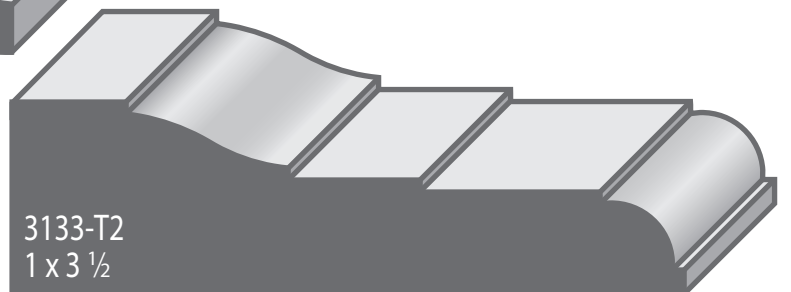

3133-T2
1 X 3 1/2

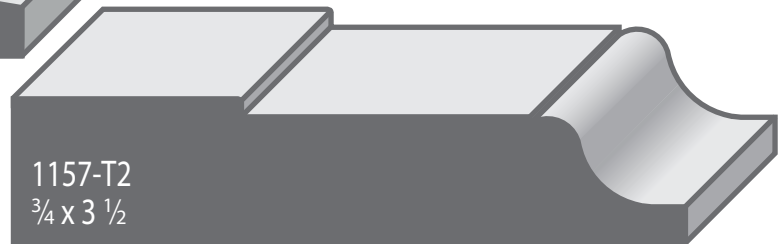
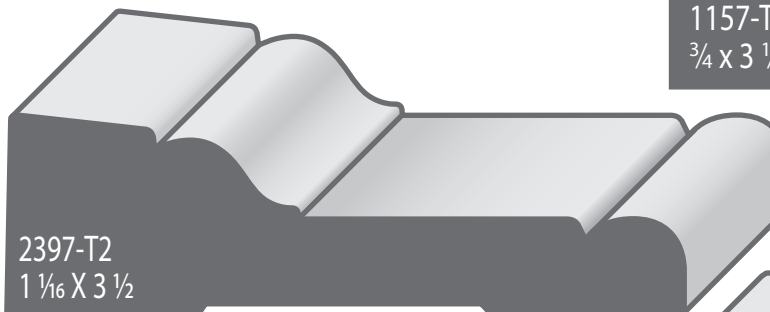
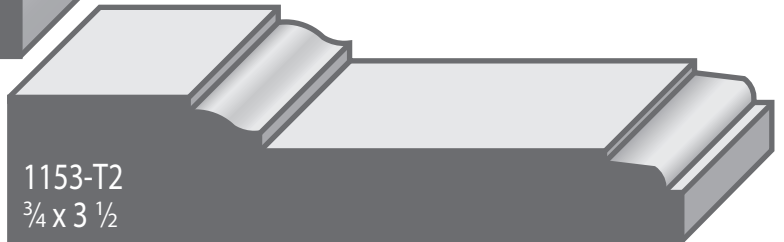
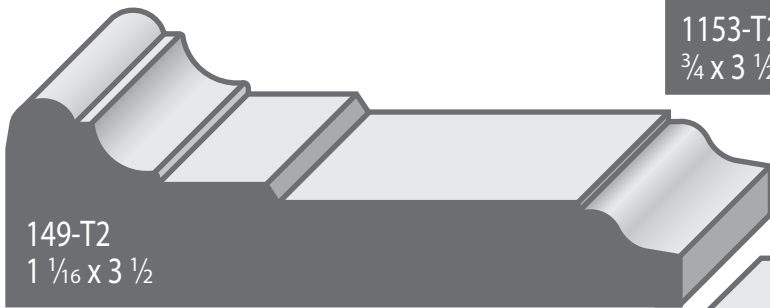
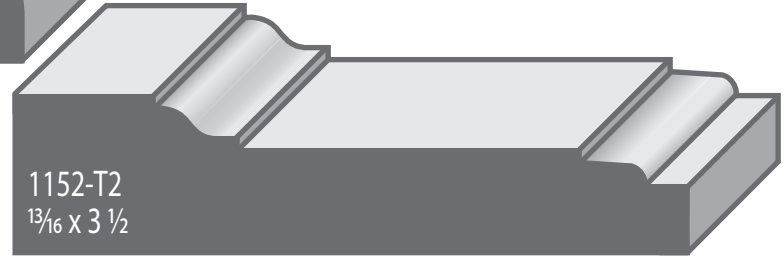
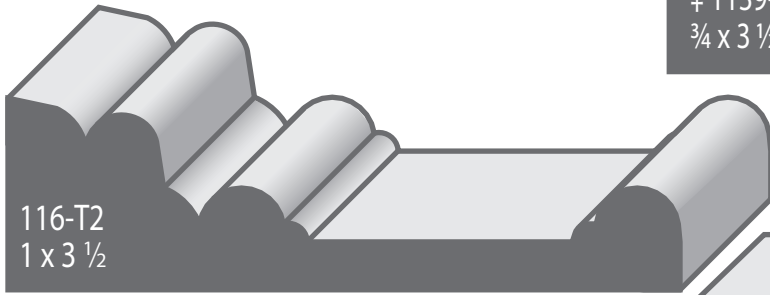



‡ Sample missing

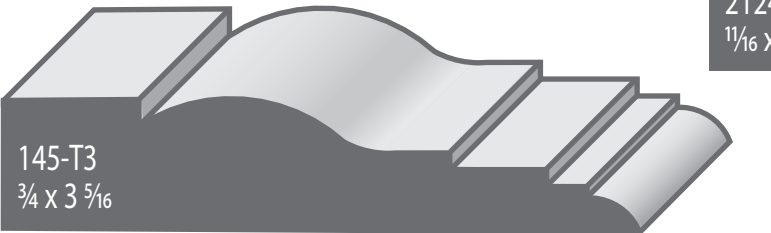
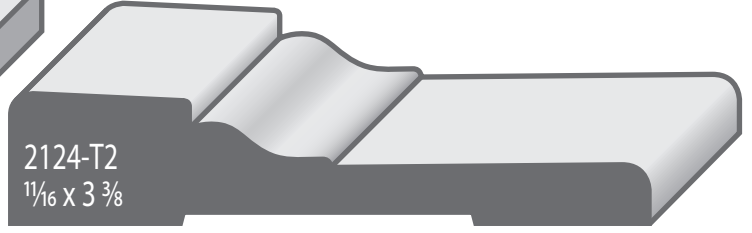
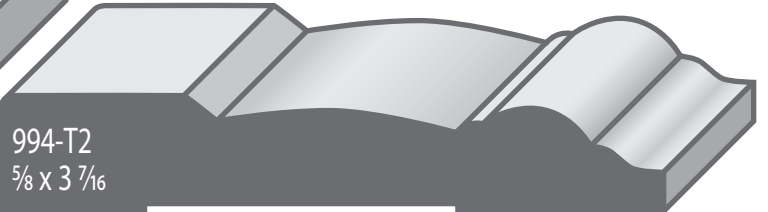
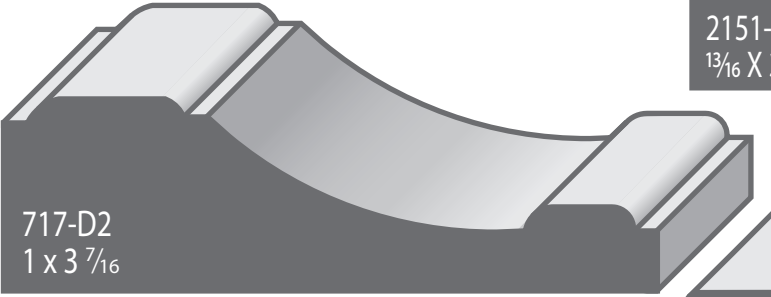
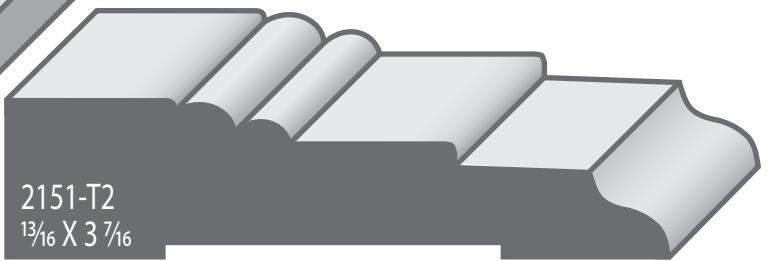
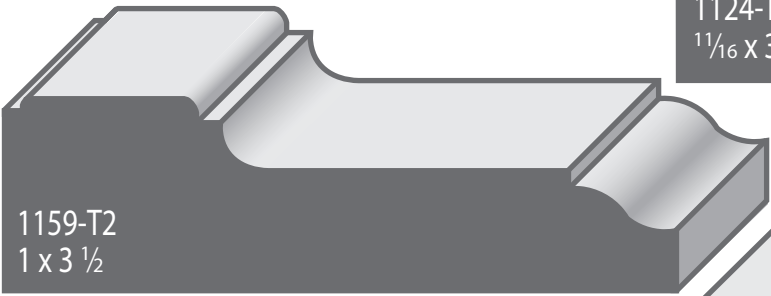
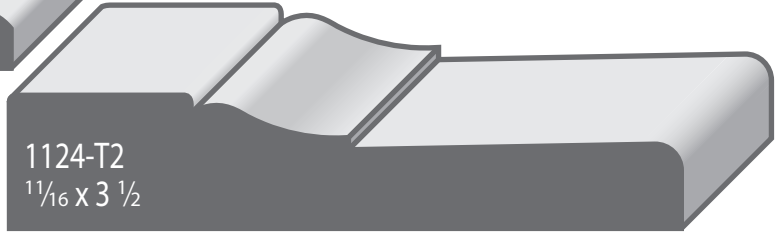
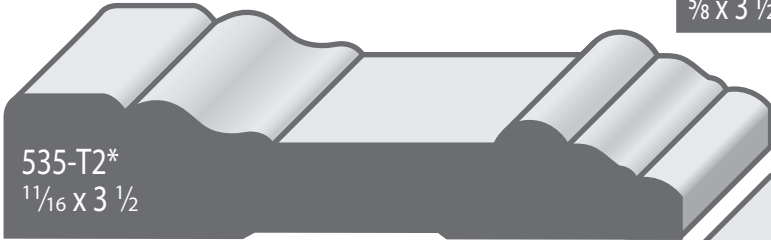

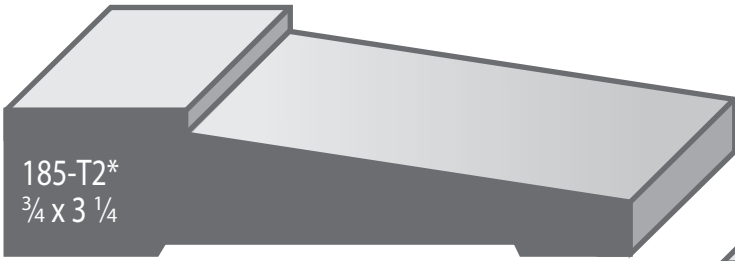

185-T2*
3/4 x 3 1/4

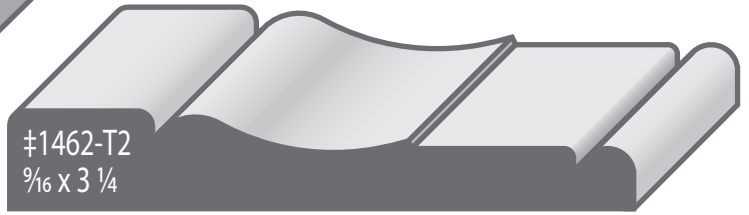

‡1462-T2
9/16 x 3 1/4



534-T2
23/32 x 3 1/4

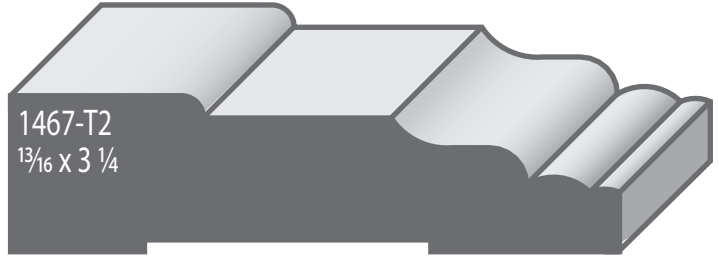

1467-T2
13/16 x 3 1/4

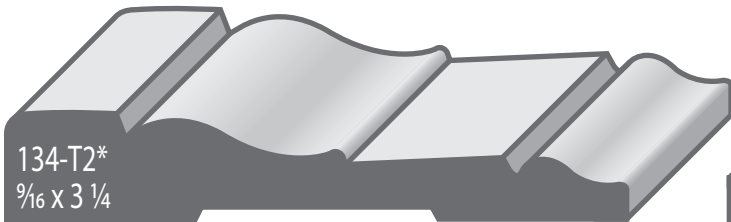

134-T2*
9/16 x 3 1/4

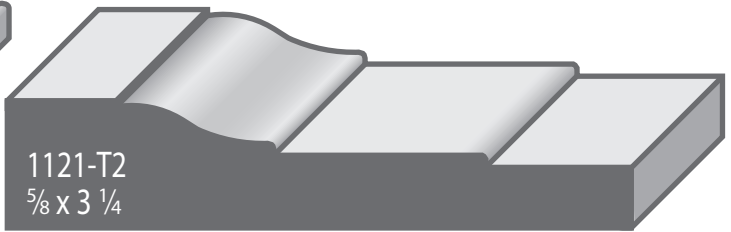

1121-T2
5/8 x 3 1/4

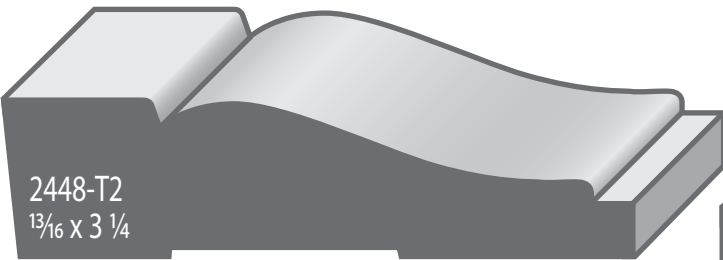

2448-T2
13/16 x 3 1/4

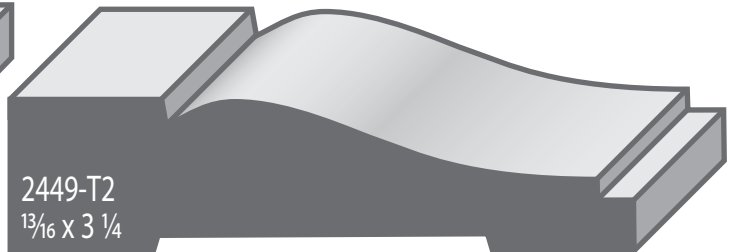

2449-T2
13/16 x 3 1/4

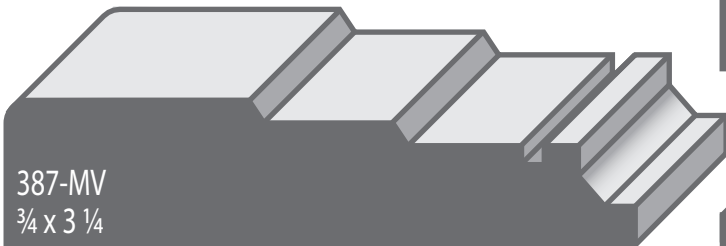

387-MV
3/4 x 3 1/4



387-T2
3/4 x 3 1/4

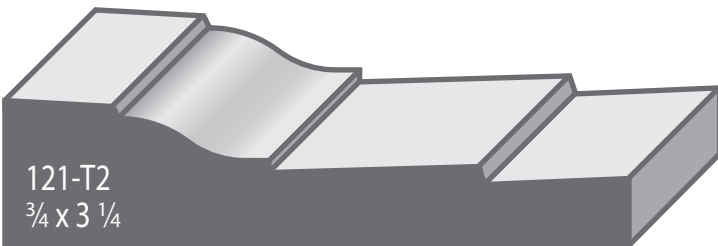

121-T2
3/4 x 3 1/4

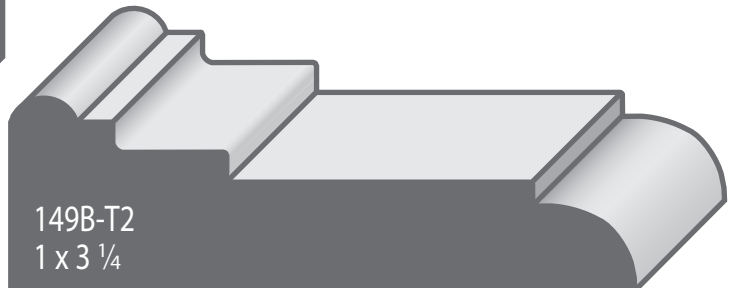

149B-T2
1 x 3 1/4



‡ Sample missing

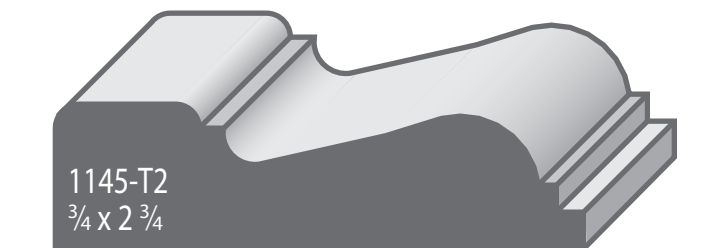
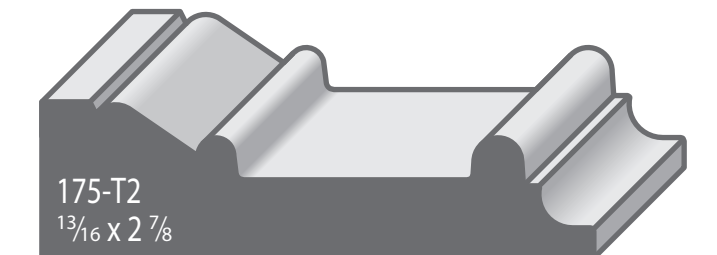
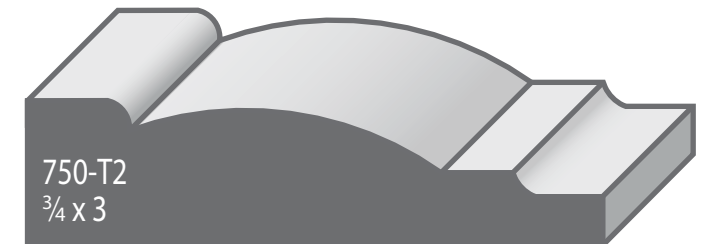
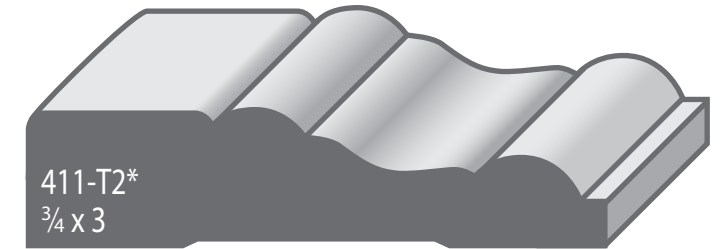
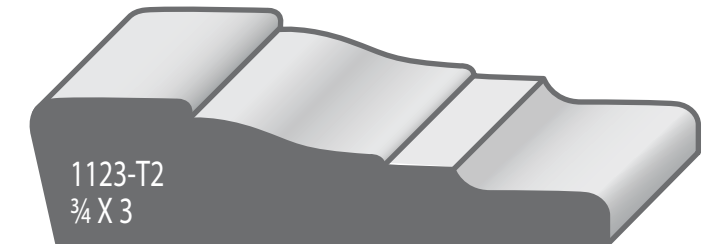
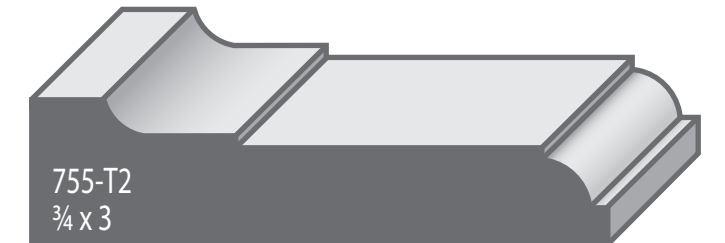
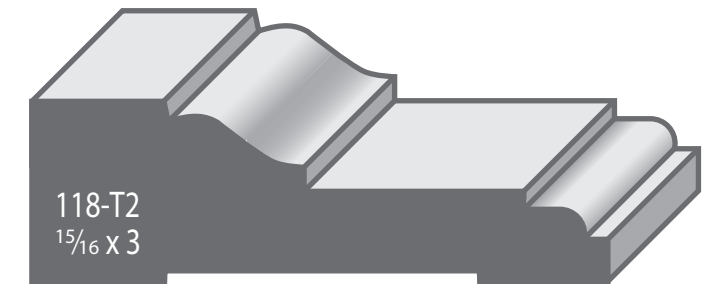
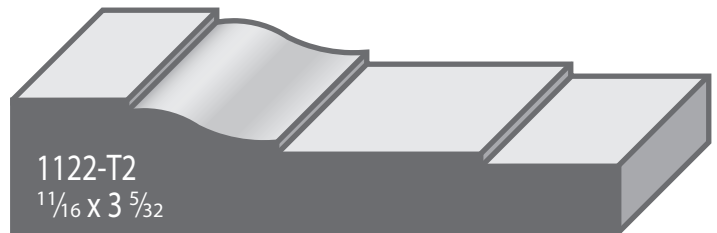
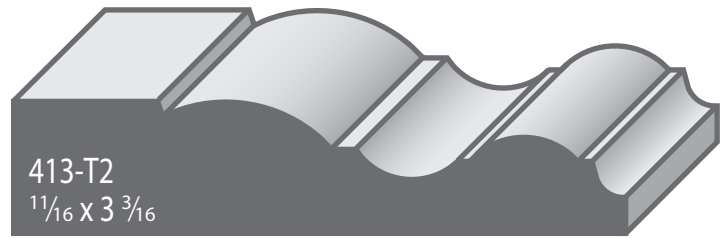
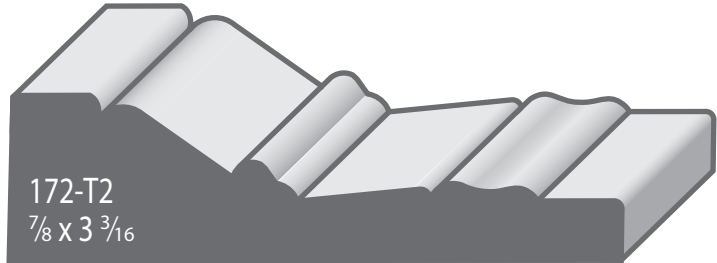
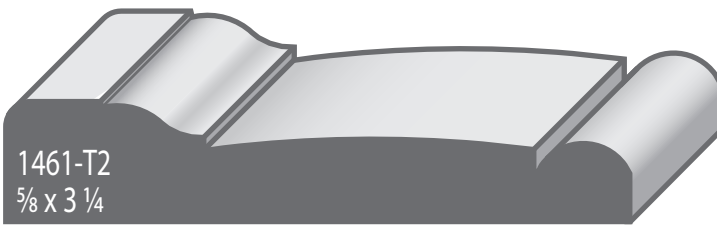

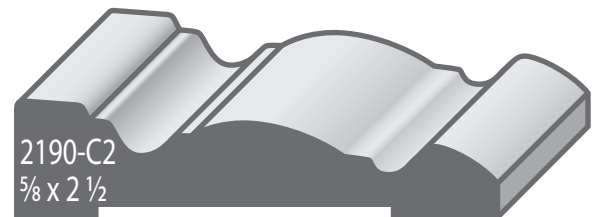
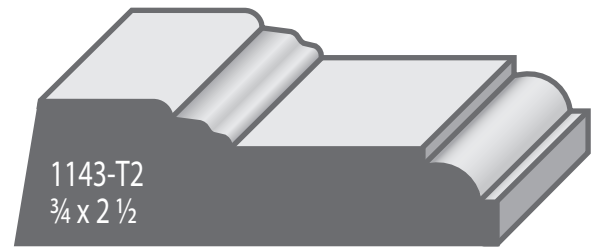
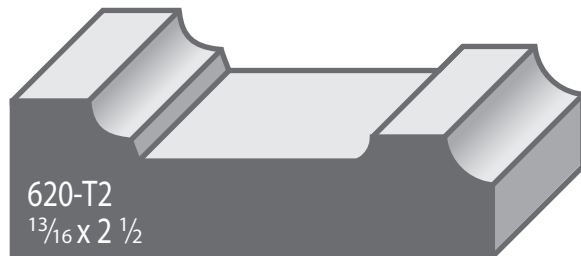
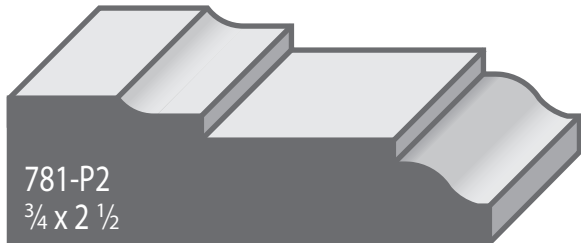
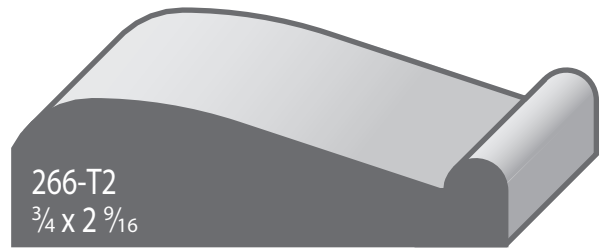
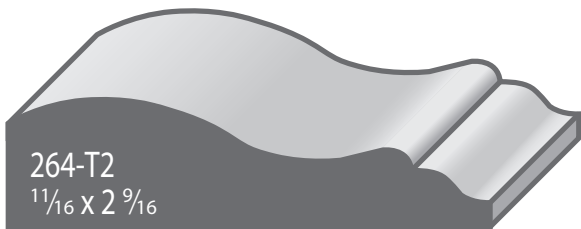
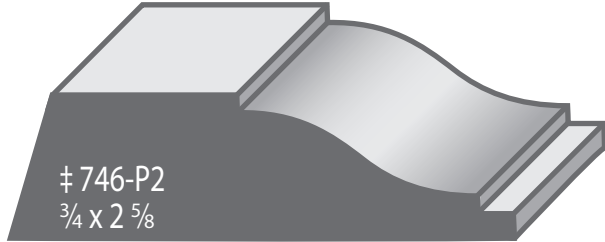
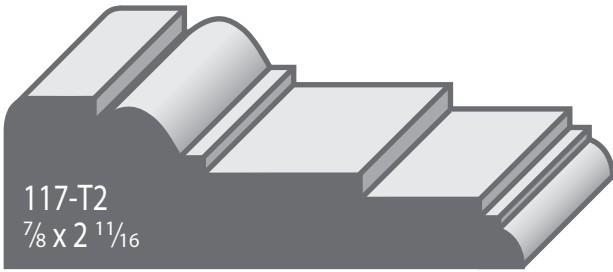



‡ Sample missing

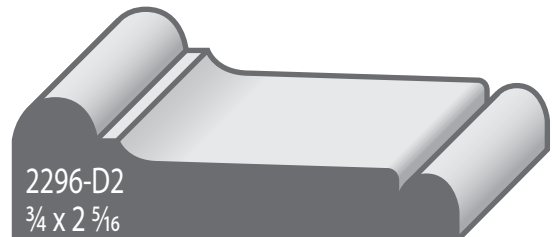
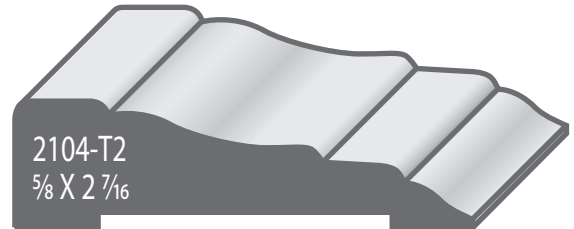
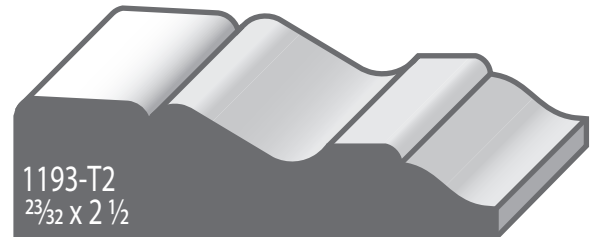
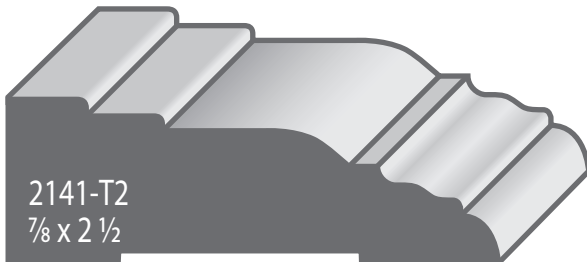
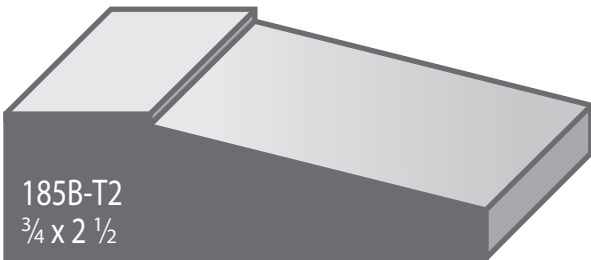
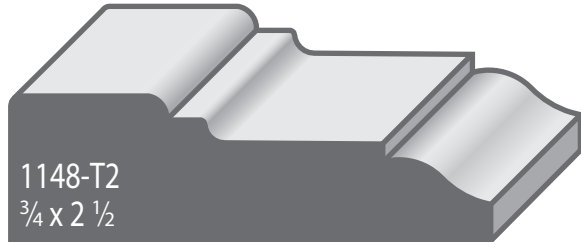
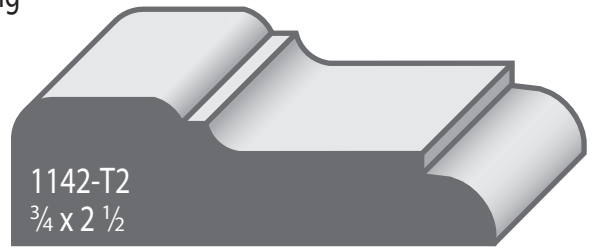
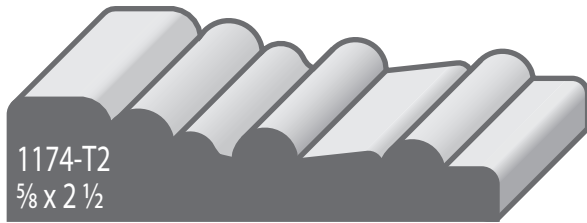

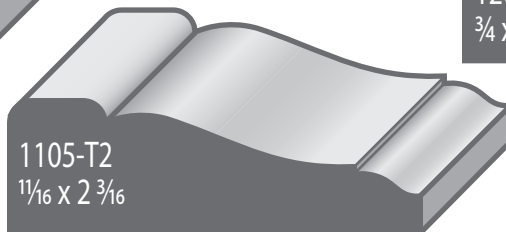
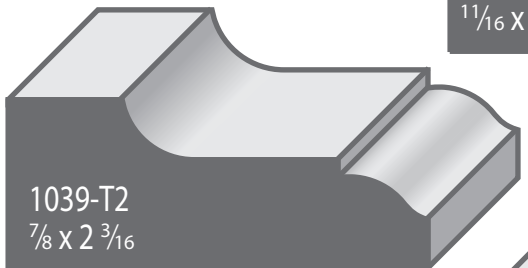
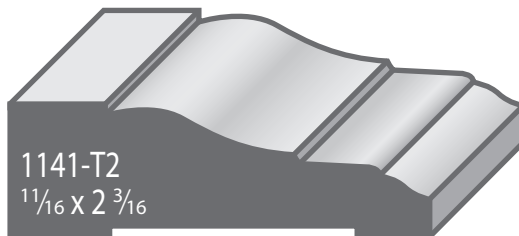
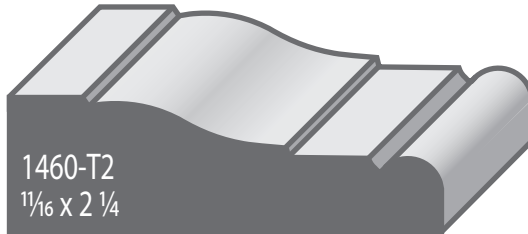
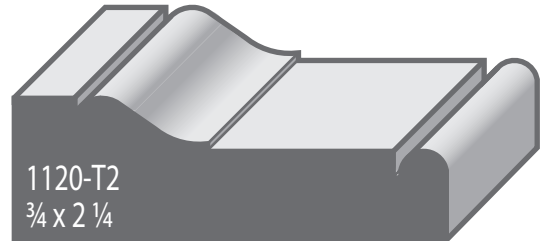
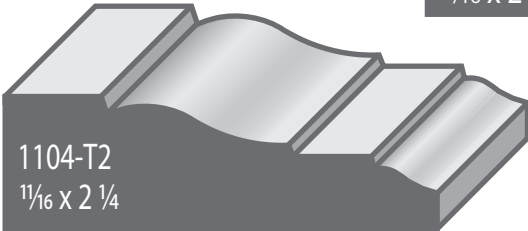
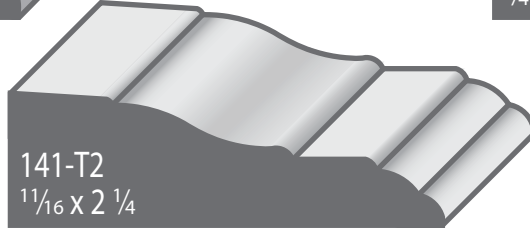
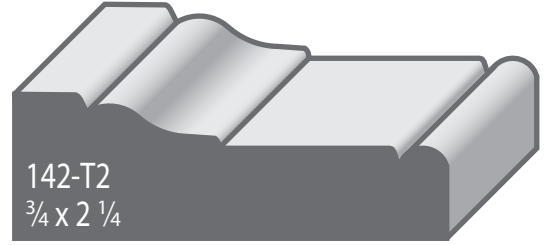
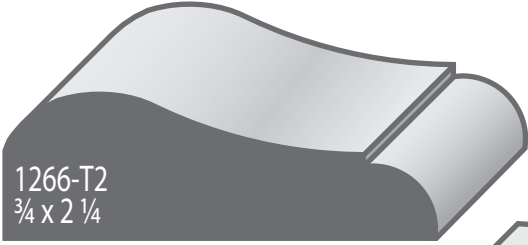

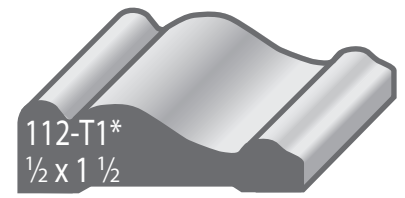
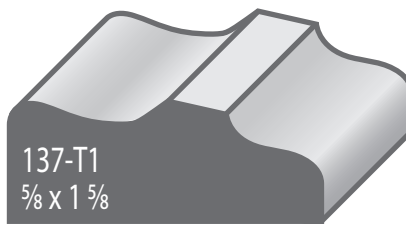
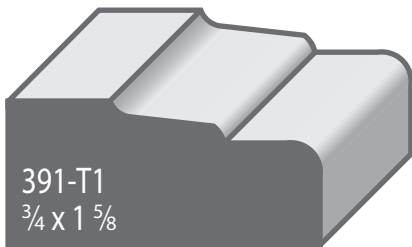
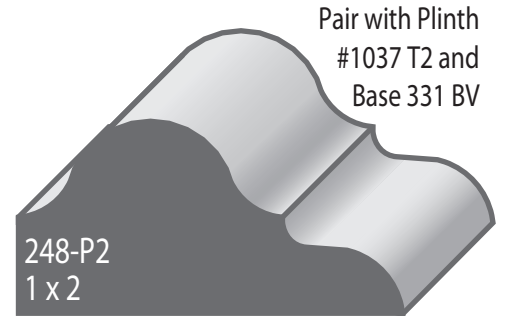
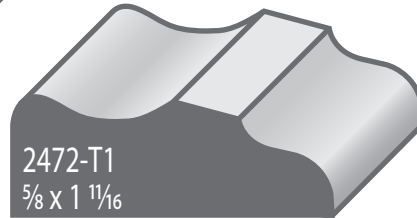



‡ Sample missing

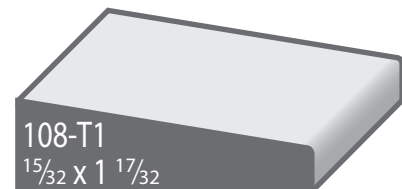
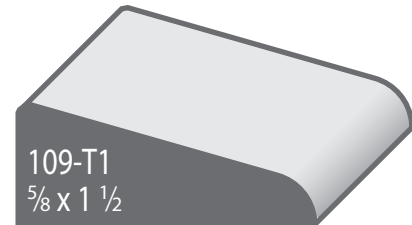
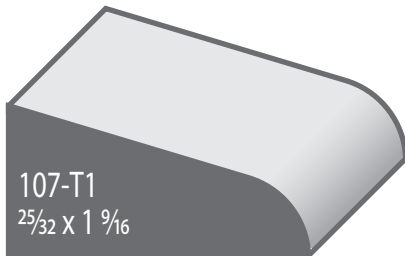
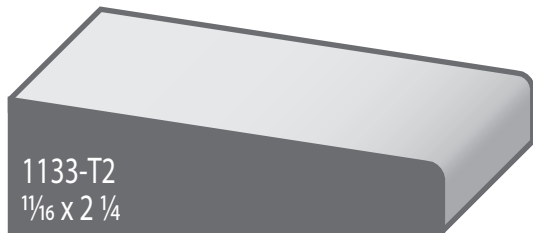
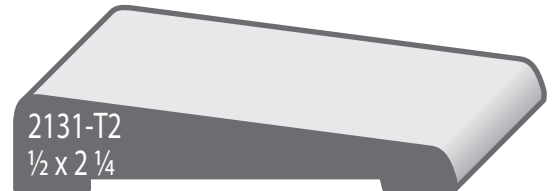
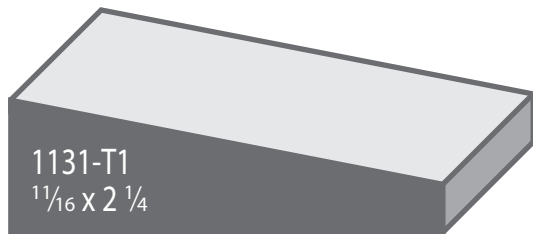
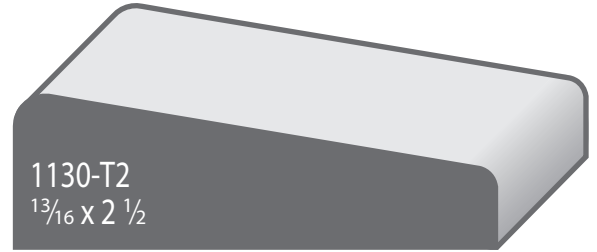
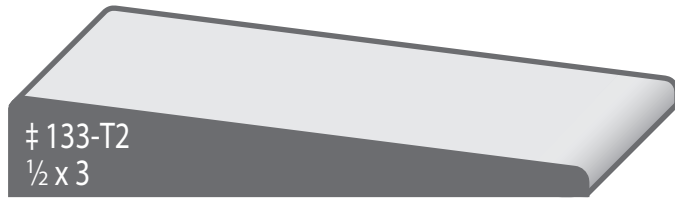

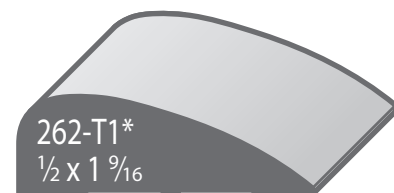
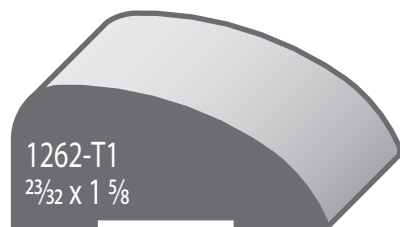
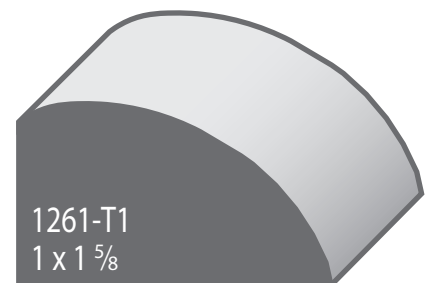
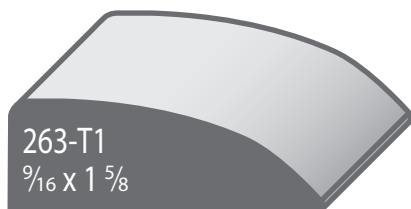
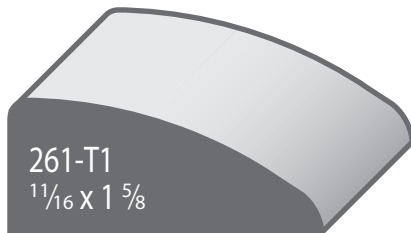
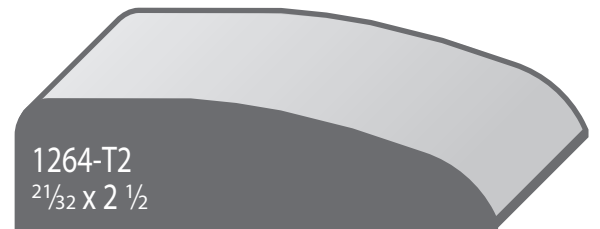



‡ Sample missing

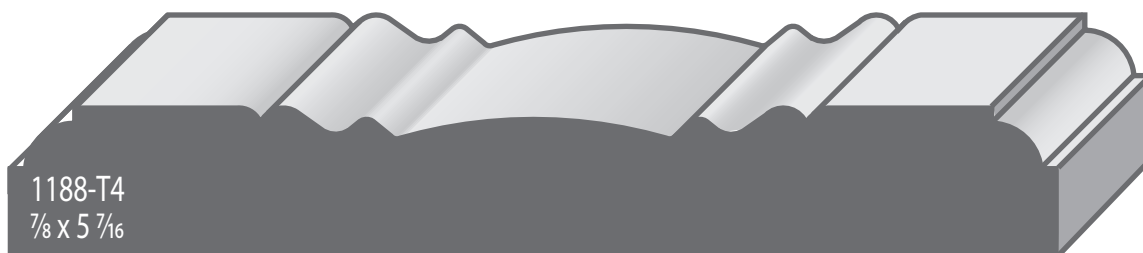
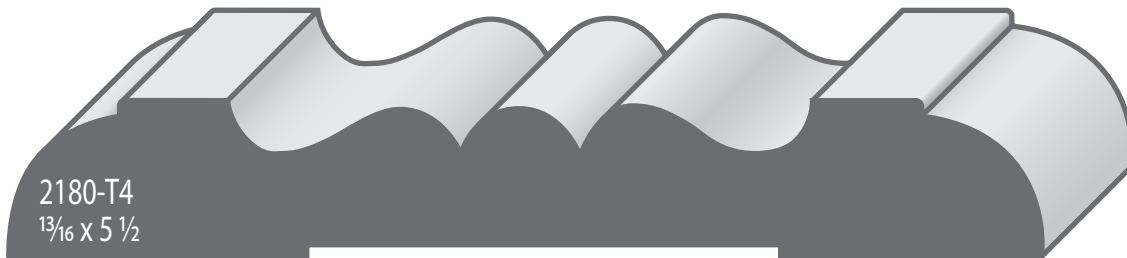
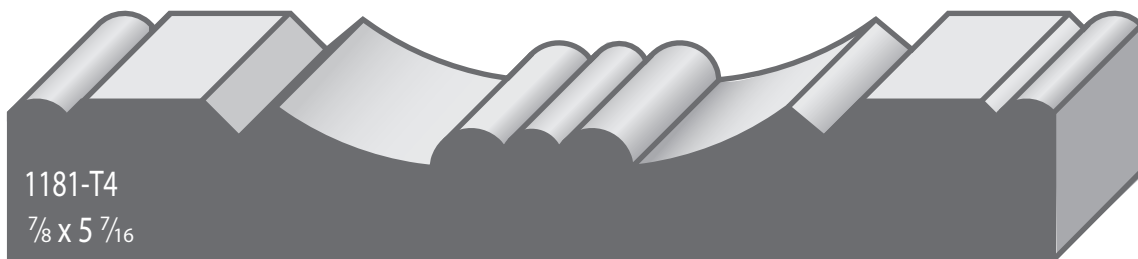
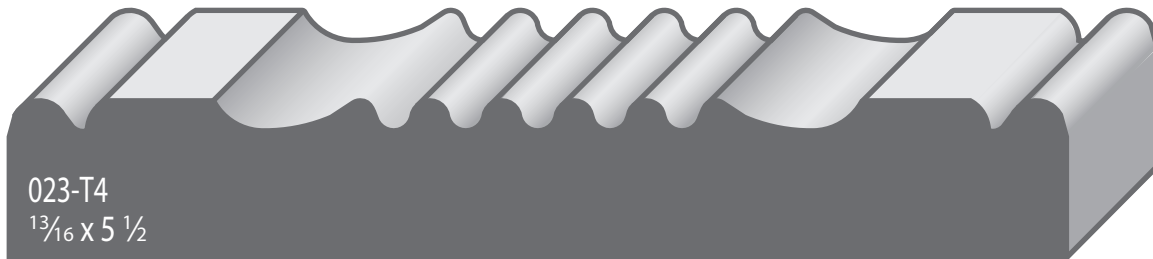
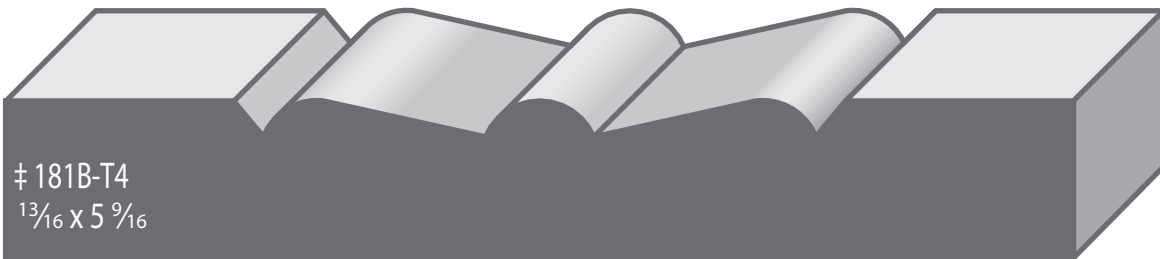

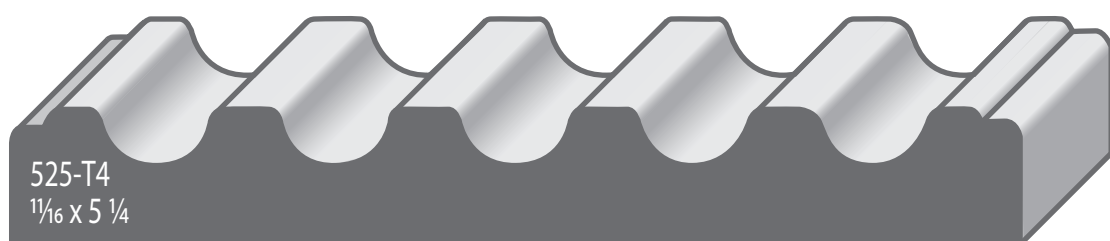
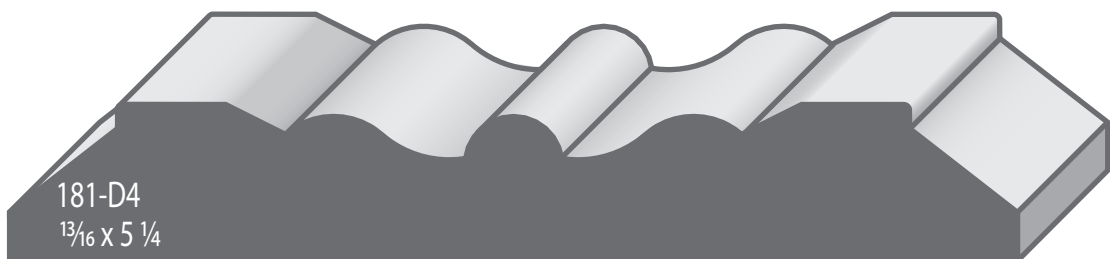
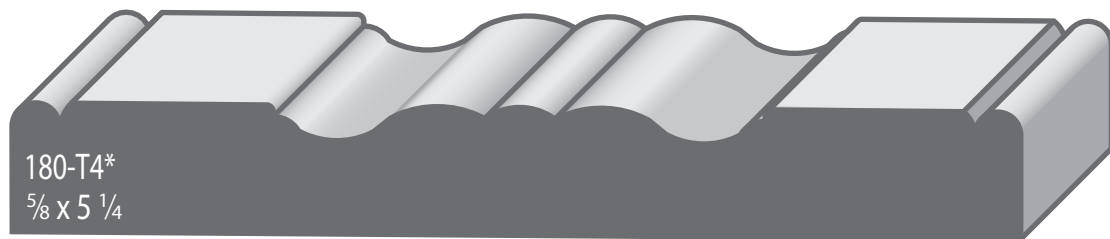
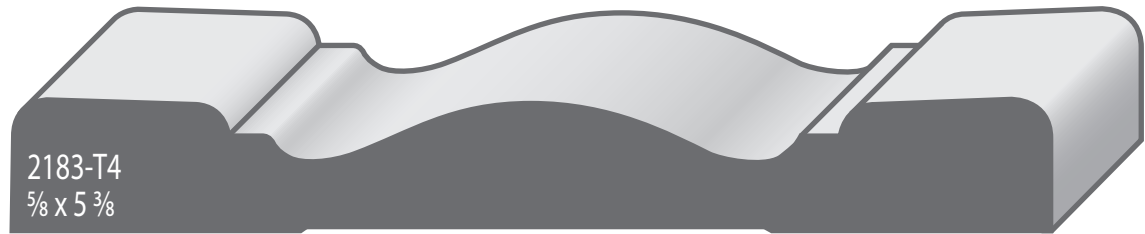
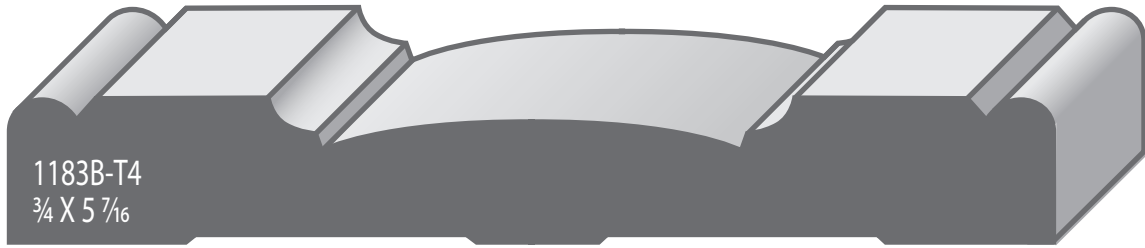



SYMMETRICAL CASINGS

‡ Sample missing

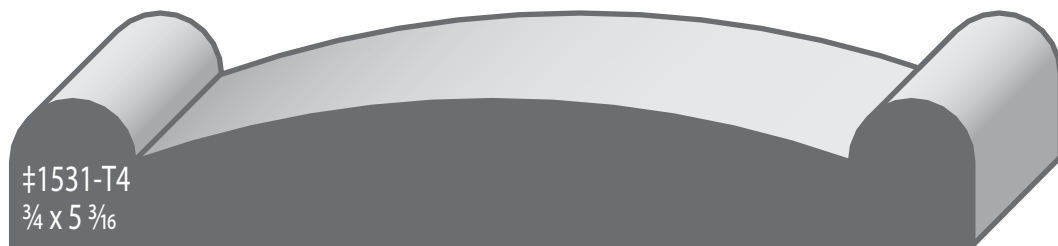
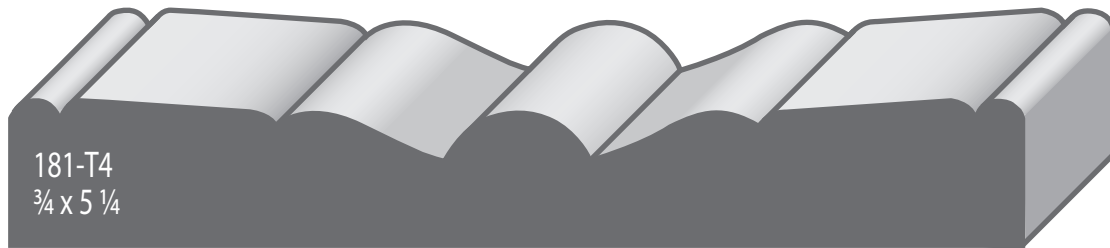
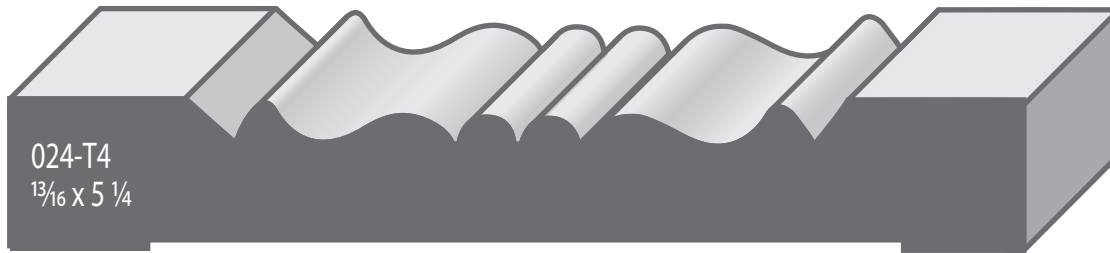
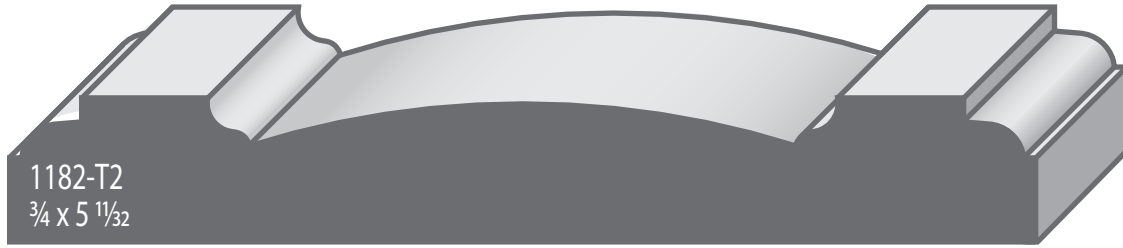

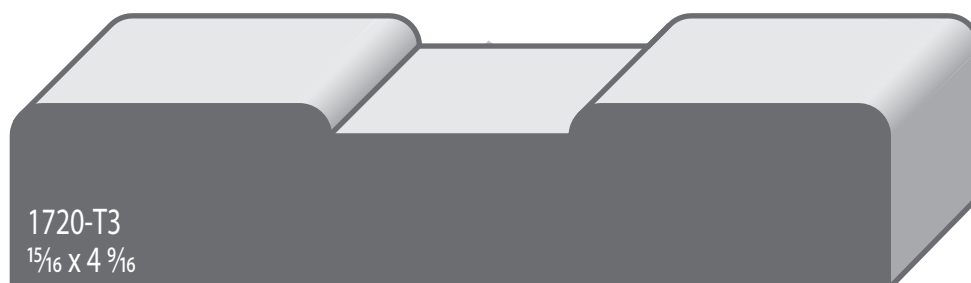
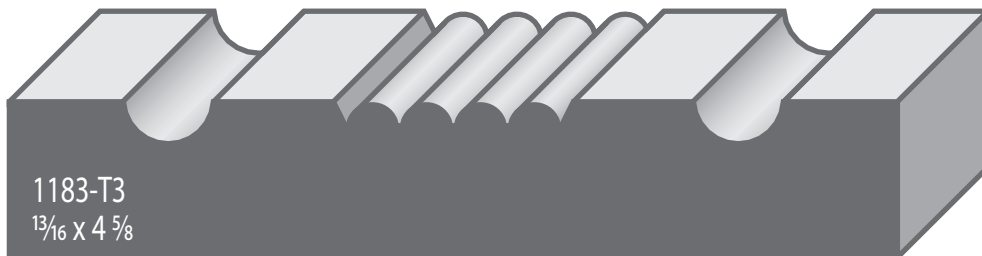
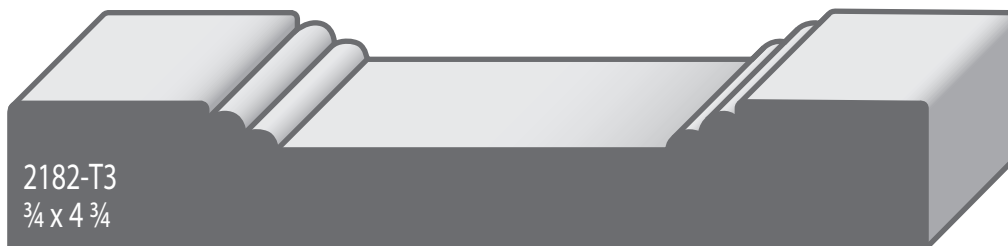
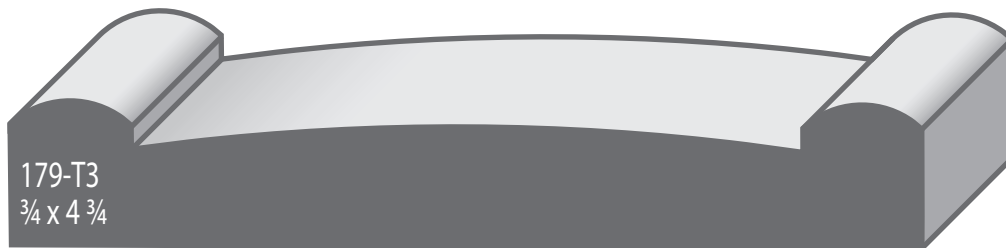
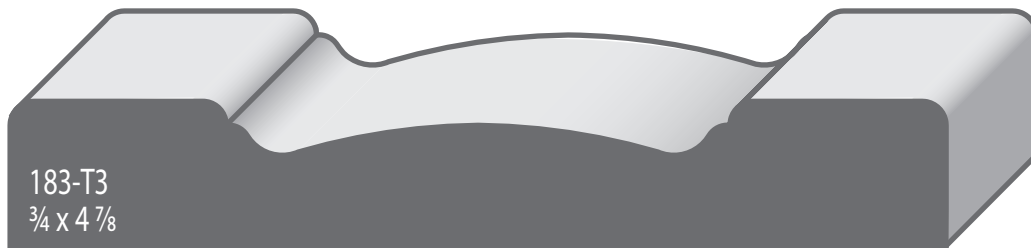

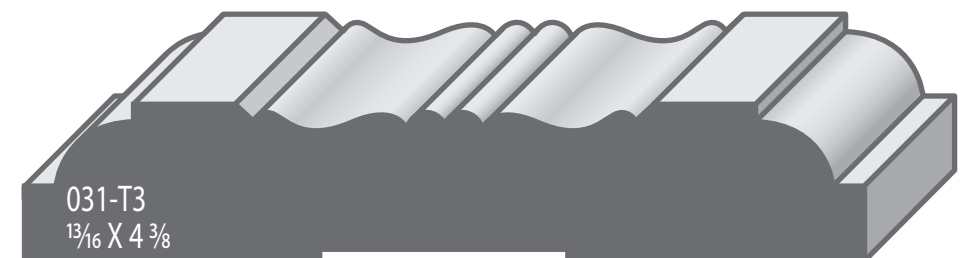
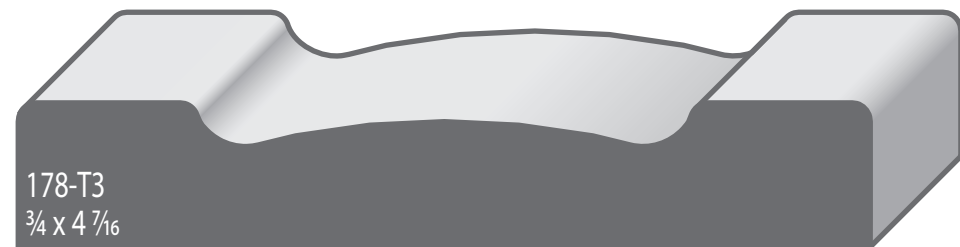
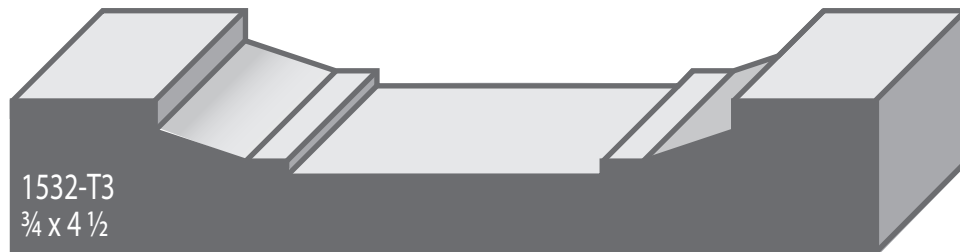
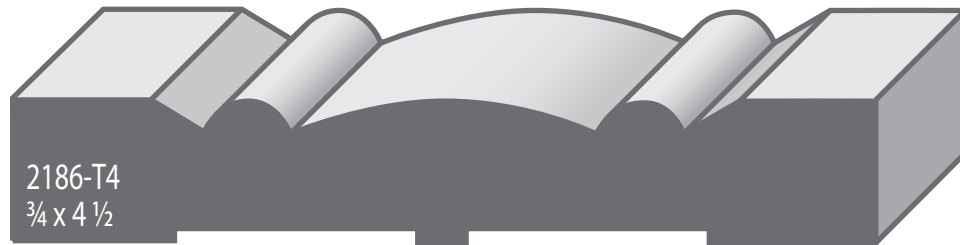
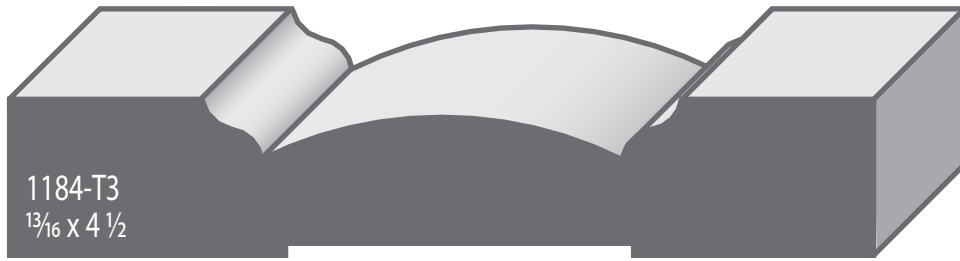



‡ Sample missing

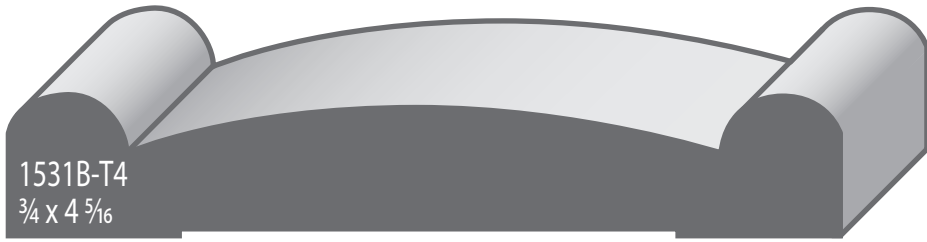

1531B-T4
3/4 x 4 5/16



2156-T2
2 3/32 x 3 1/2



1526-T2
3/4 x 3 7/16



029-T2
5/8 x 3 1/2



2817-T2
1 3/16 x 3 3/8

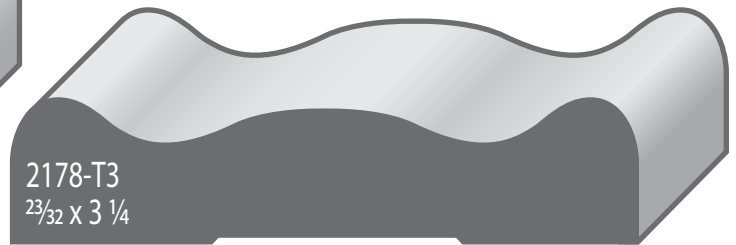

2178-T3
2 3/32 x 3 1/4

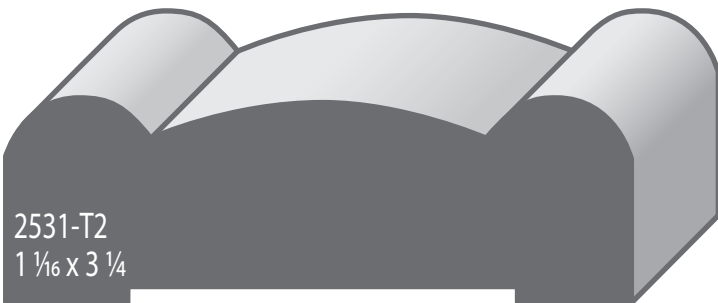

2531-T2
1 1/16 x 3 1/4



529-T2
1 1/16 x 3



894-D2
3/4 x 2 7/8

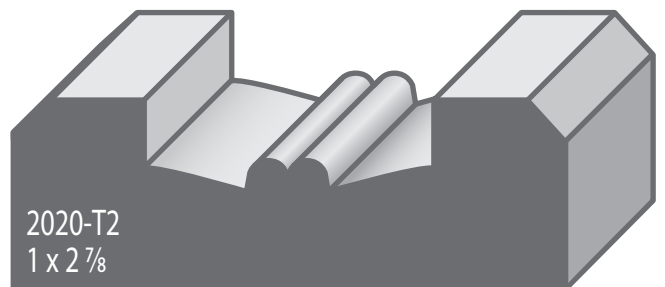

2020-T2
1 x 2 7/8

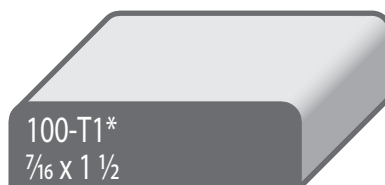
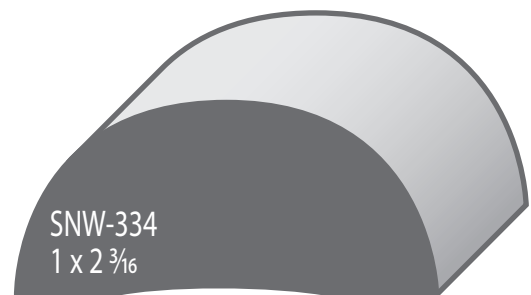
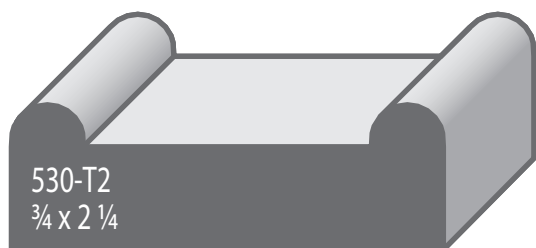
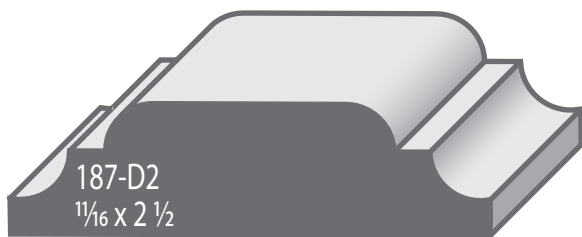
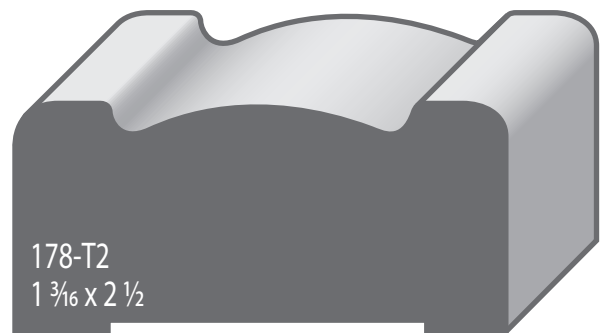
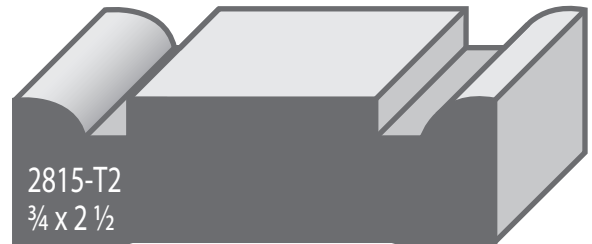
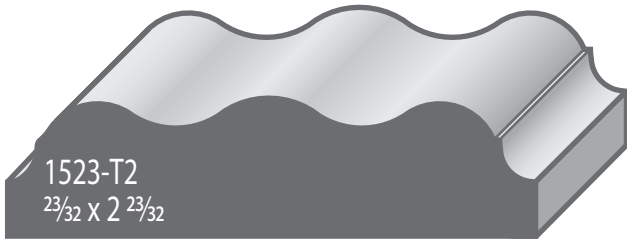

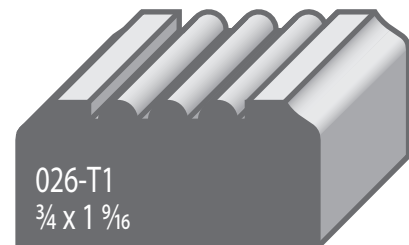
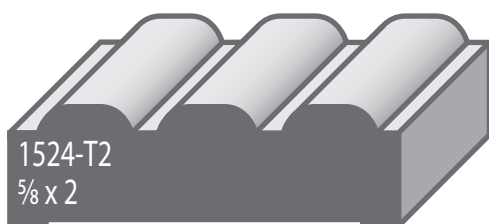
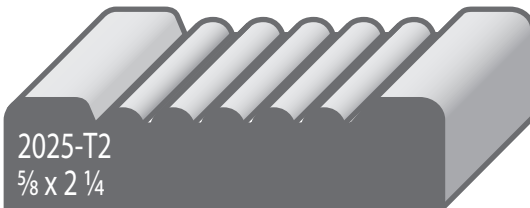
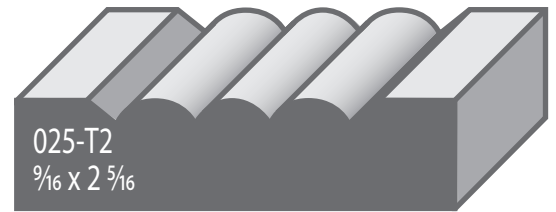
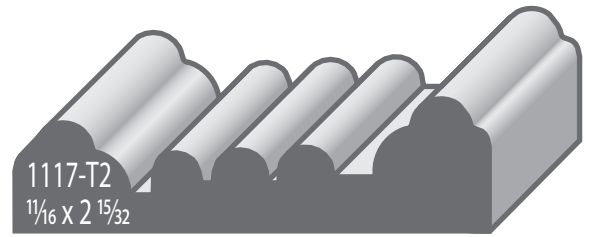
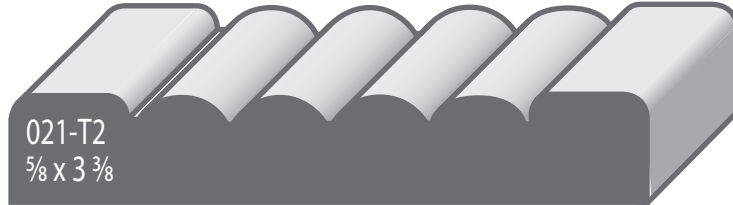
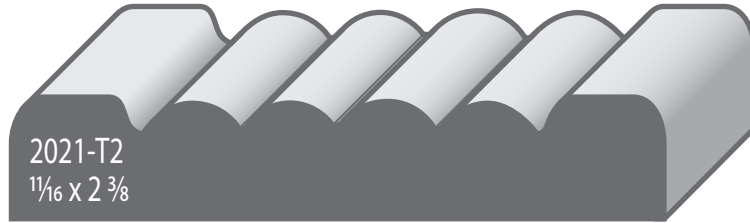

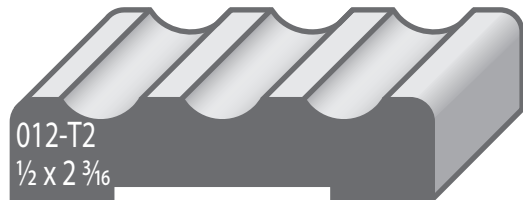
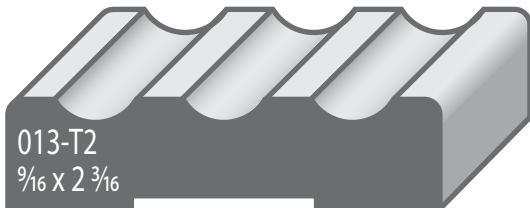
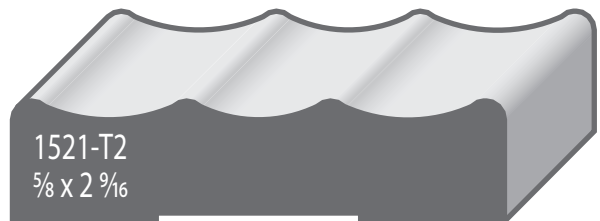
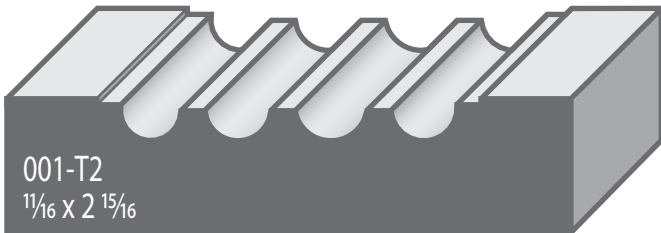
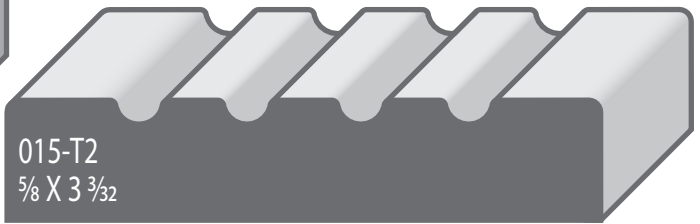
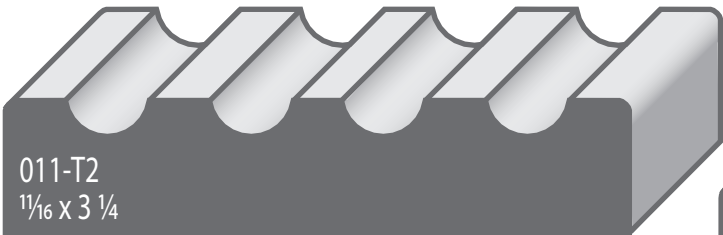
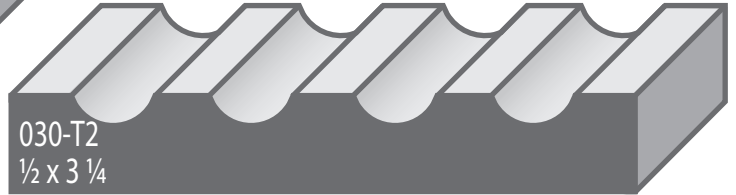
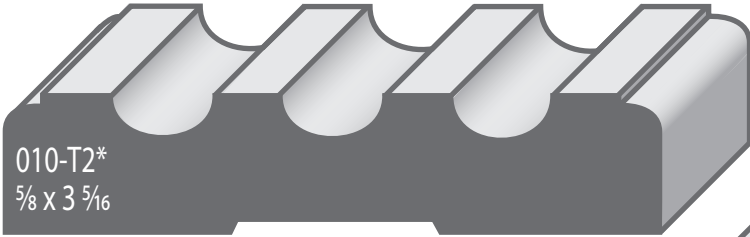
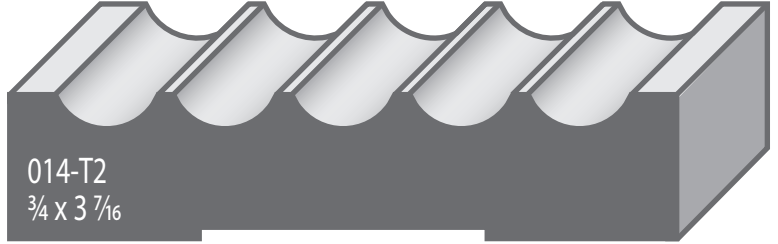
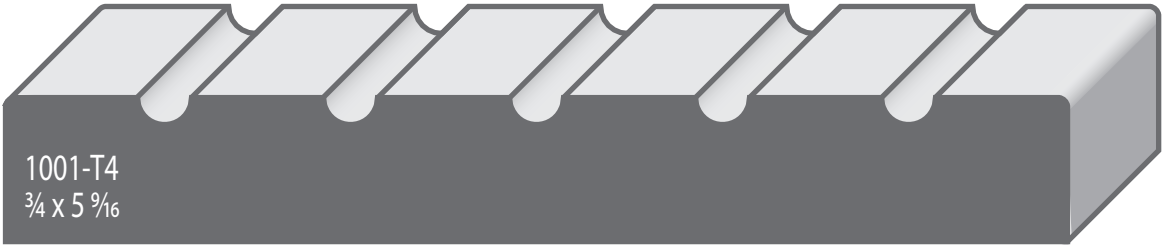

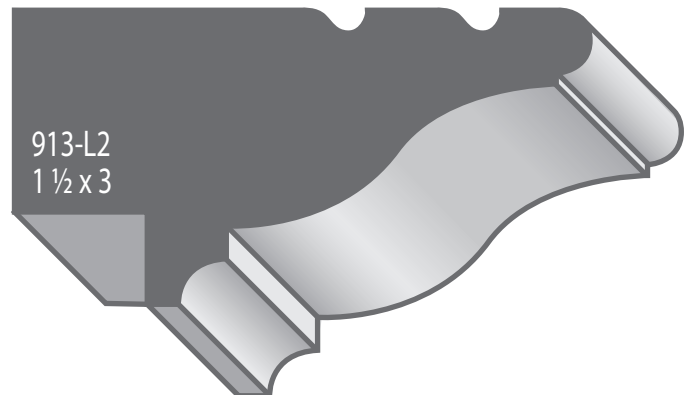
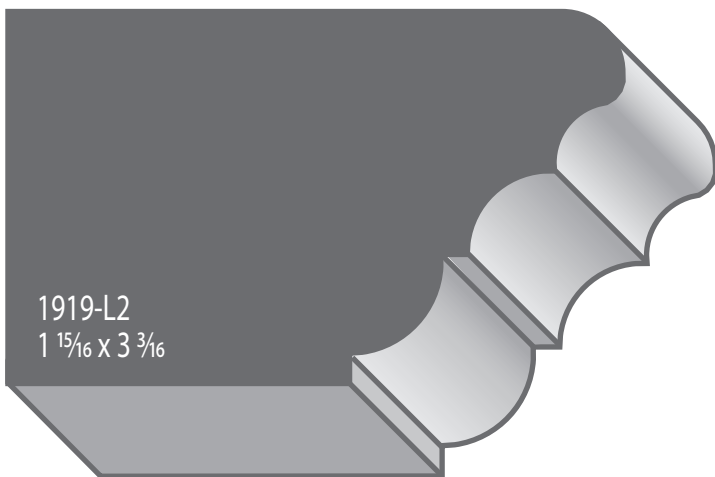
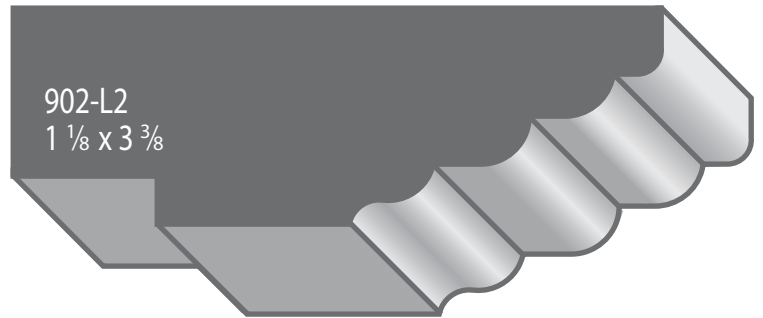
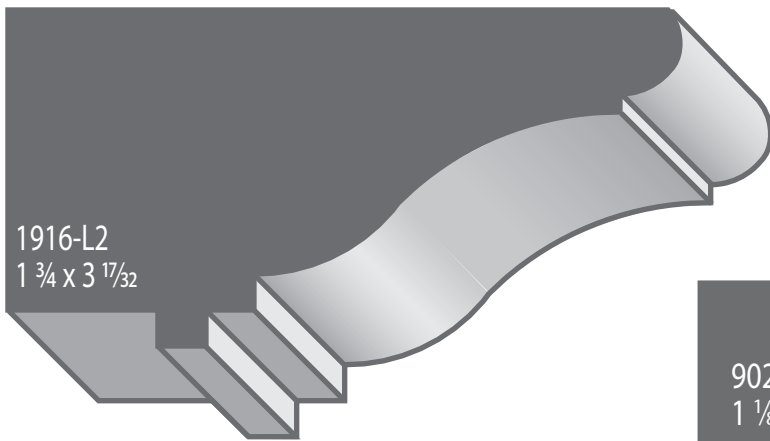
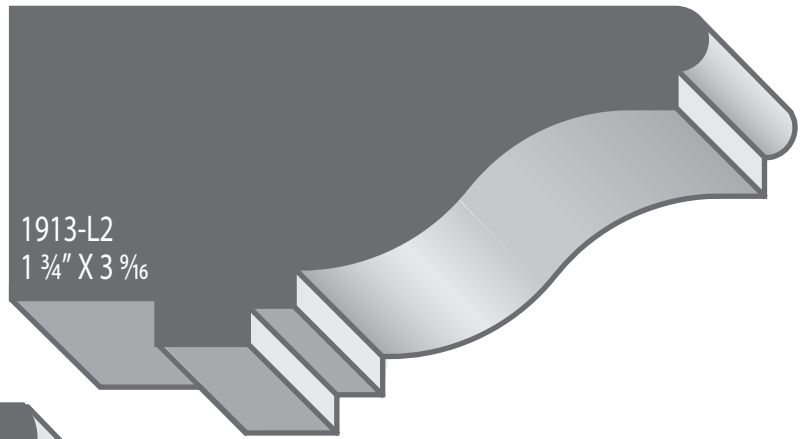
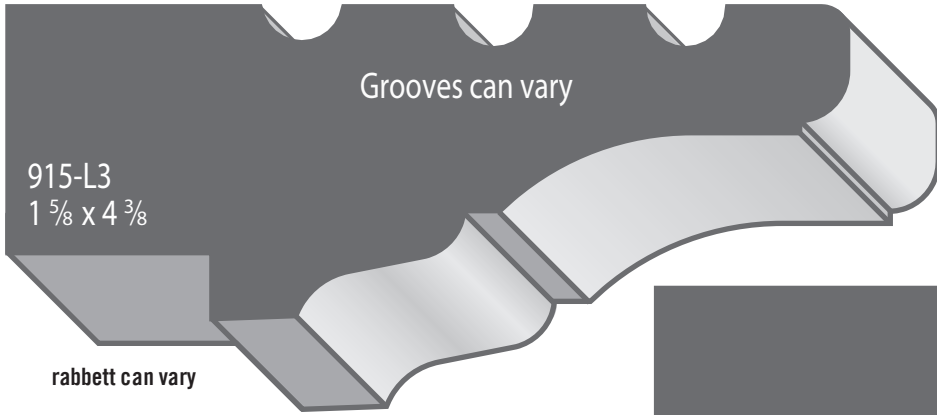

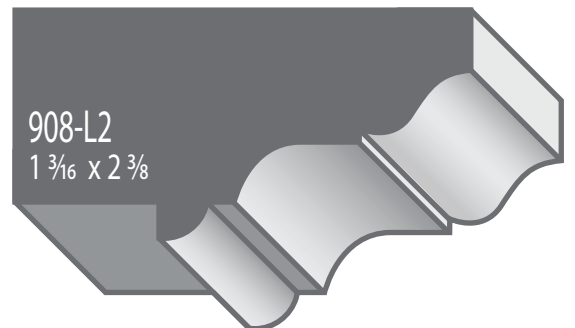
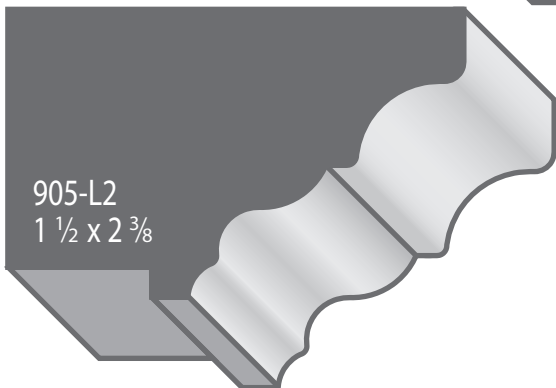
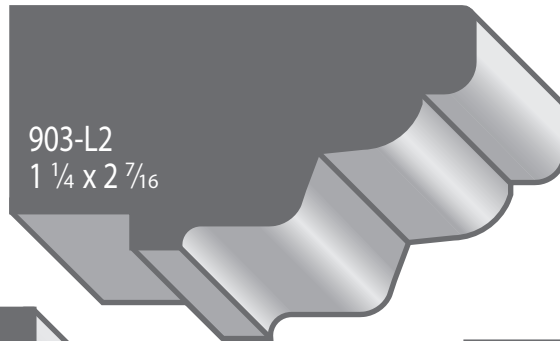
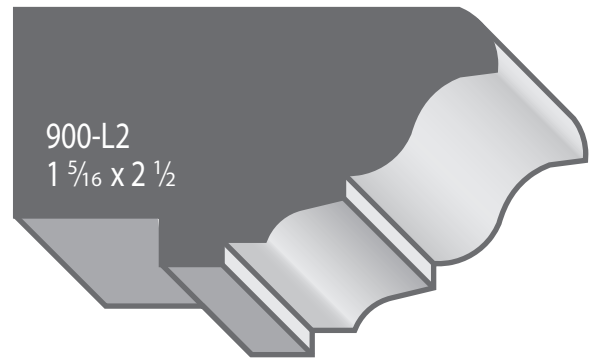
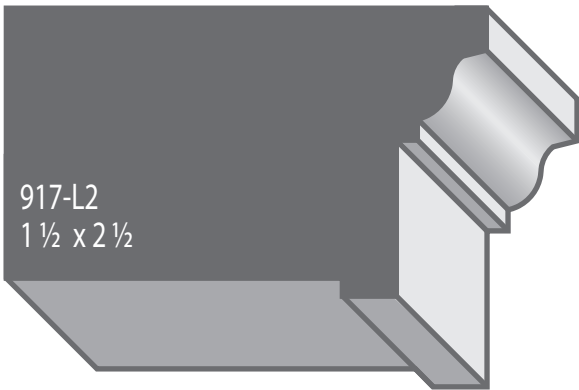
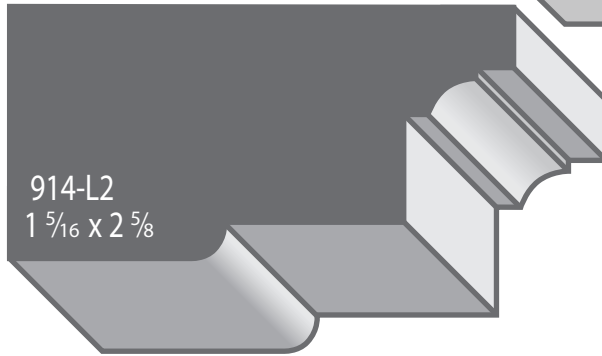
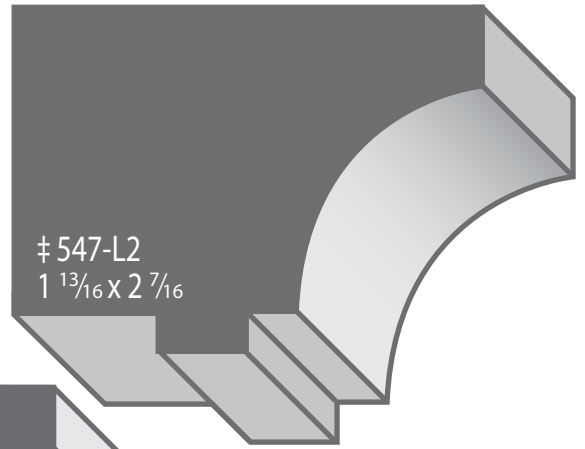
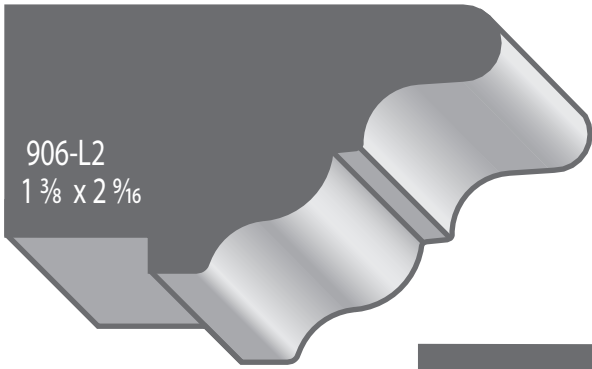



‡ Sample missing

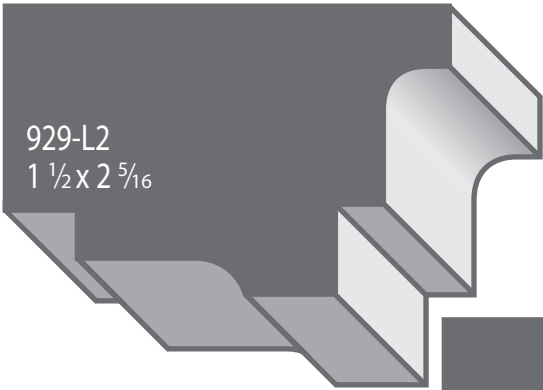

929-L2
1 1/2 x 2 5/16

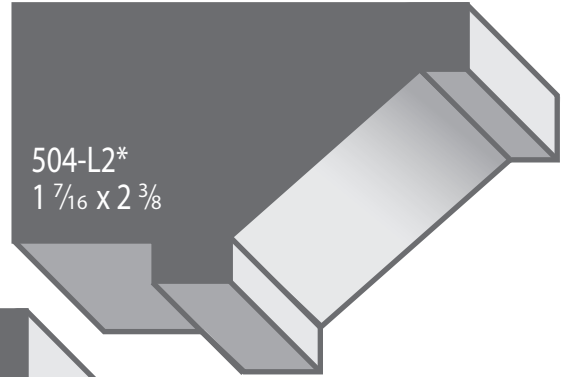

504-L2*
1 7/16 x 2 3/8

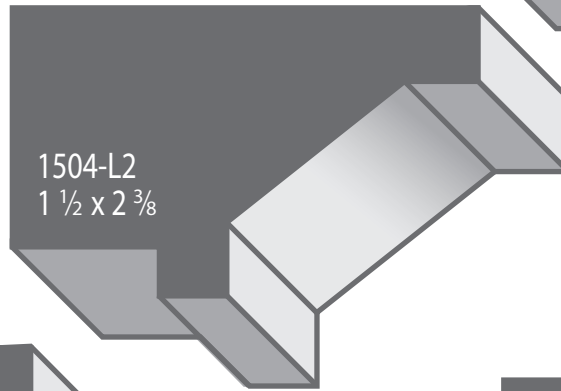

1504-L2
1 1/2 x 2 3/8

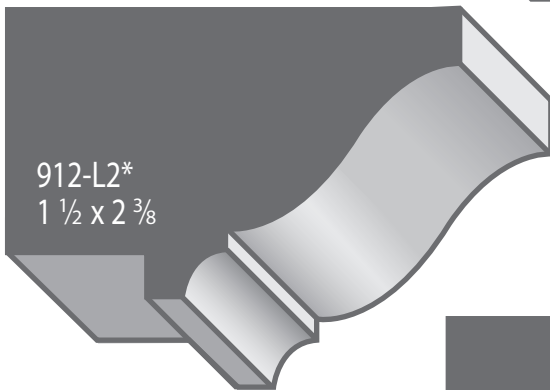

912-L2*
1 1/2 x 2 3/8

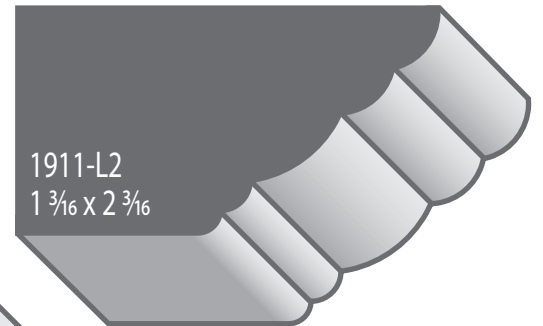

1911-L2
1 3/16 x 2 3/16

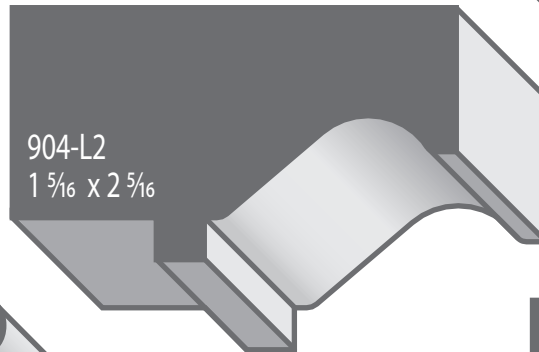

904-L2
1 5/16 x 2 5/16

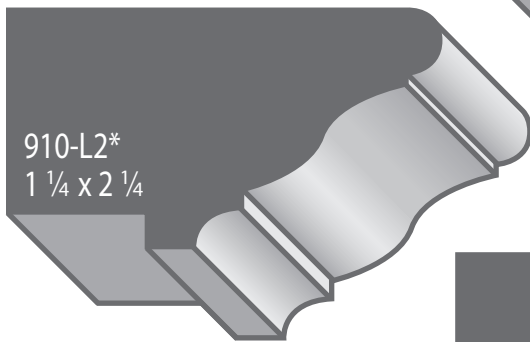

910-L2*
1 1/4 x 2 1/4

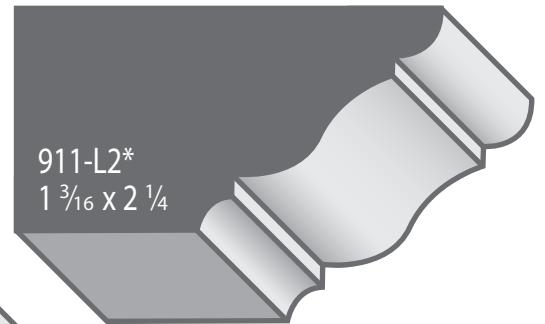

911-L2*
1 3/16 x 2 1/4

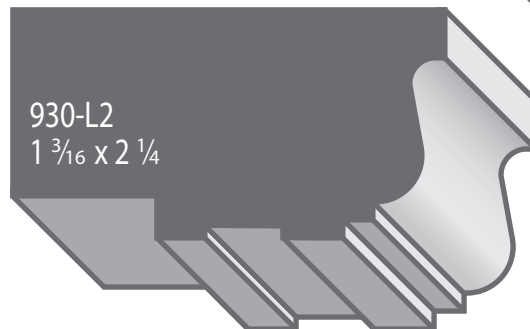

930-L2
1 3/16 x 2 1/4



‡ Sample missing

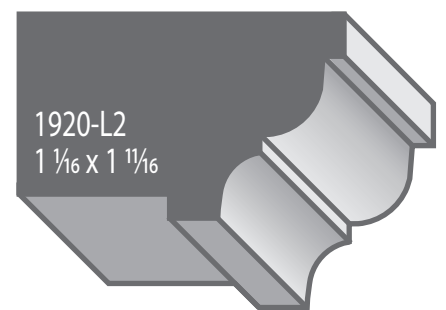
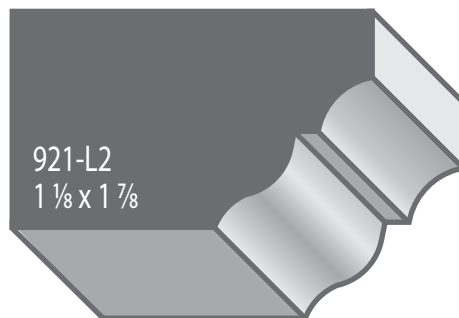
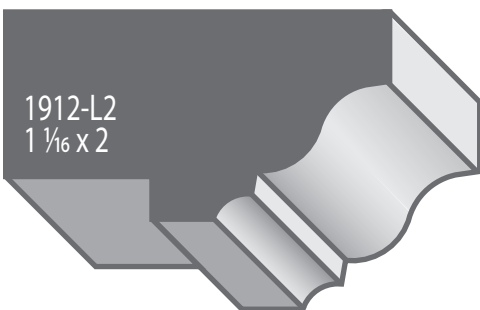
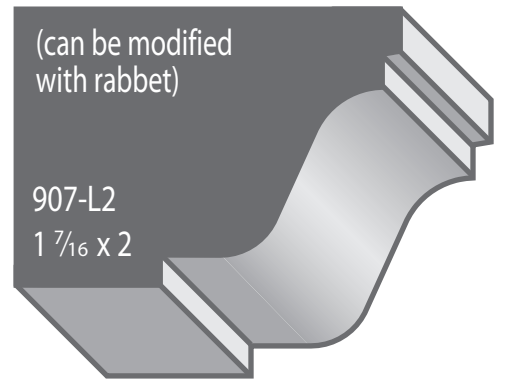
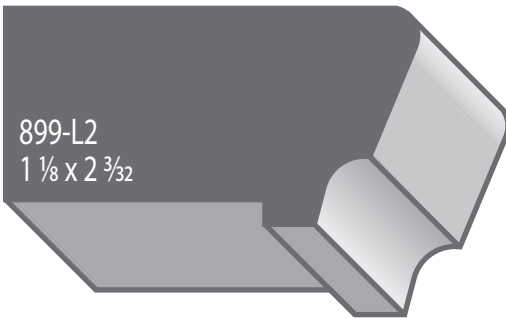
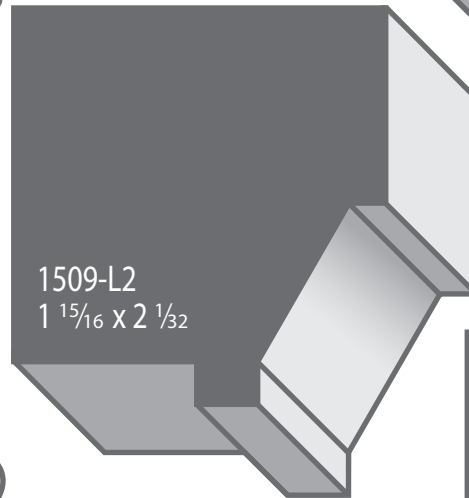
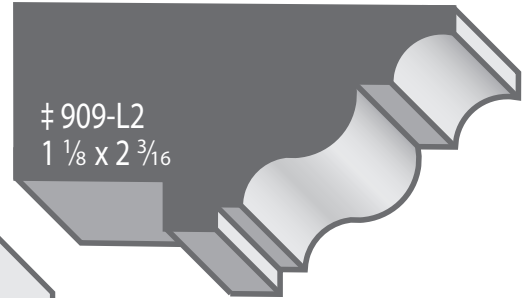
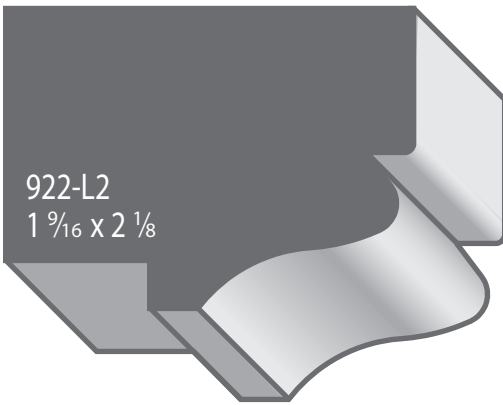
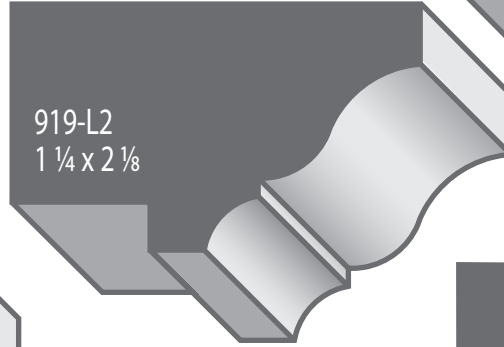
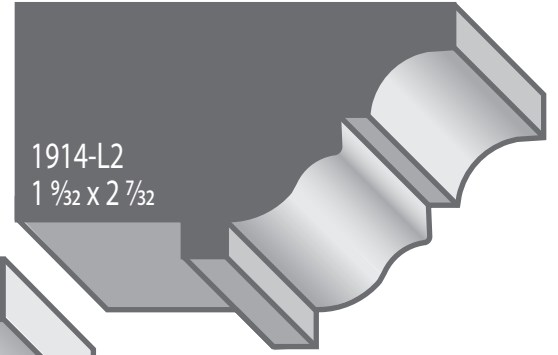
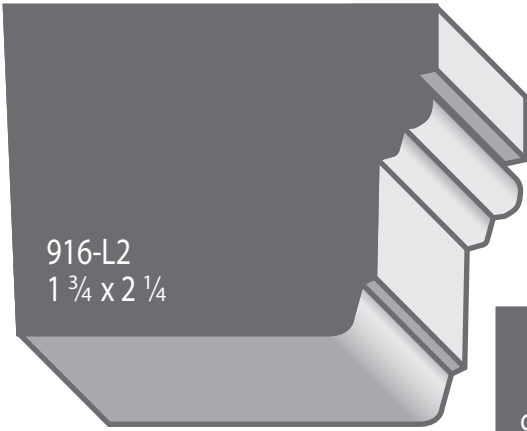

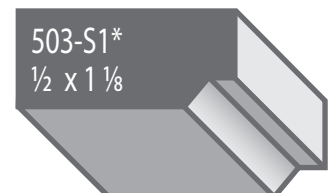
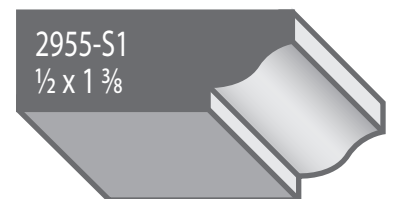
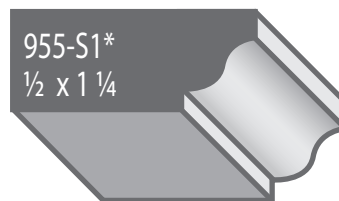
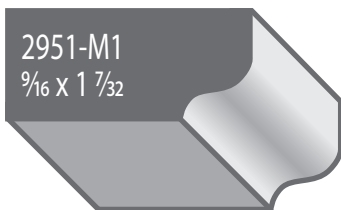
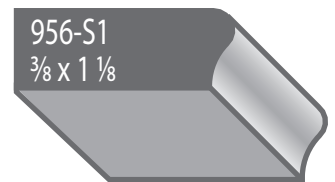
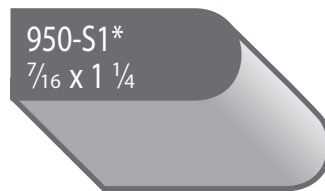
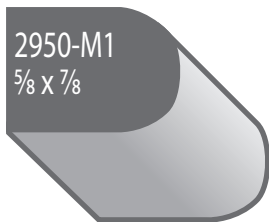
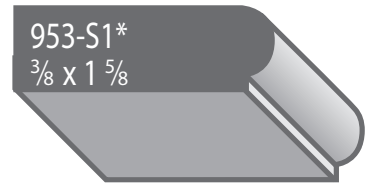
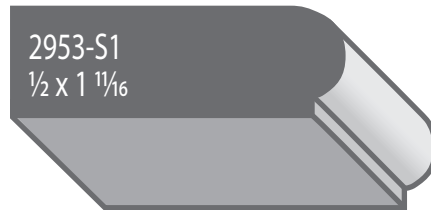
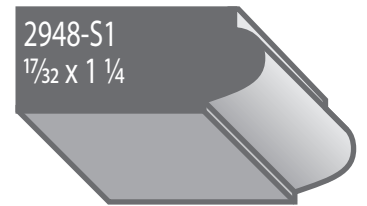
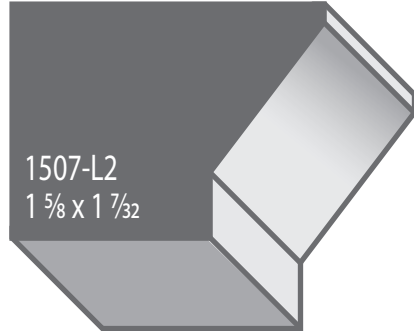
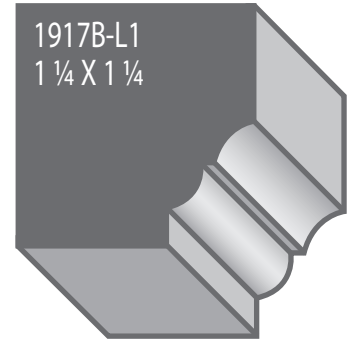
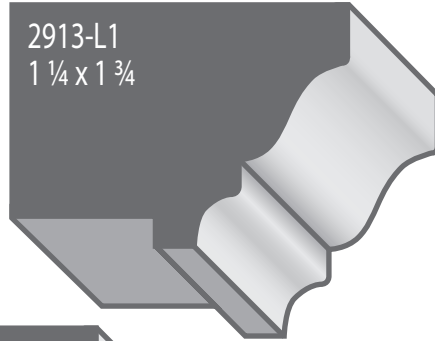
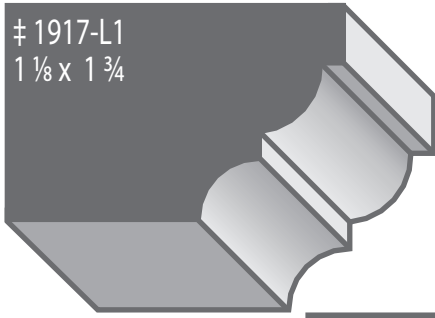



‡ Sample missing

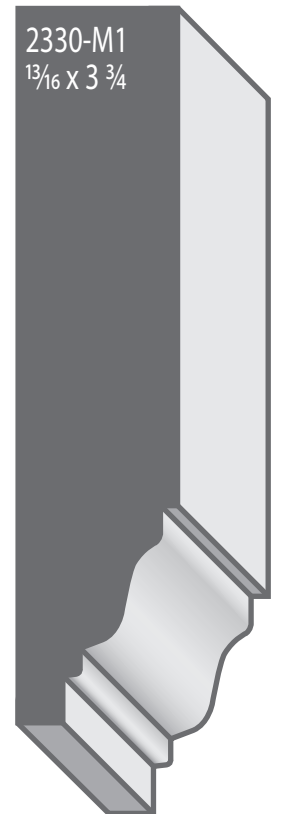
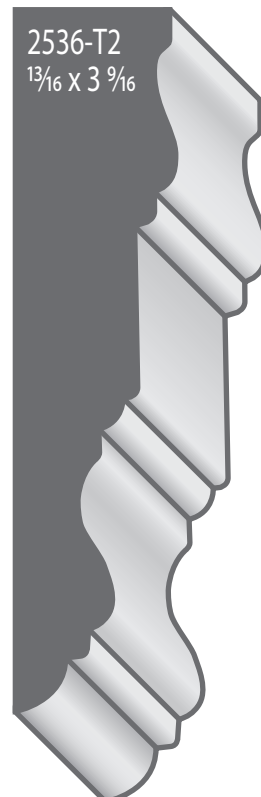
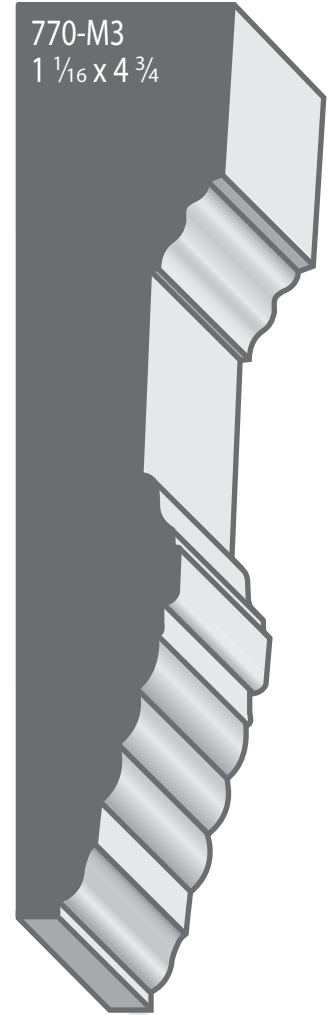
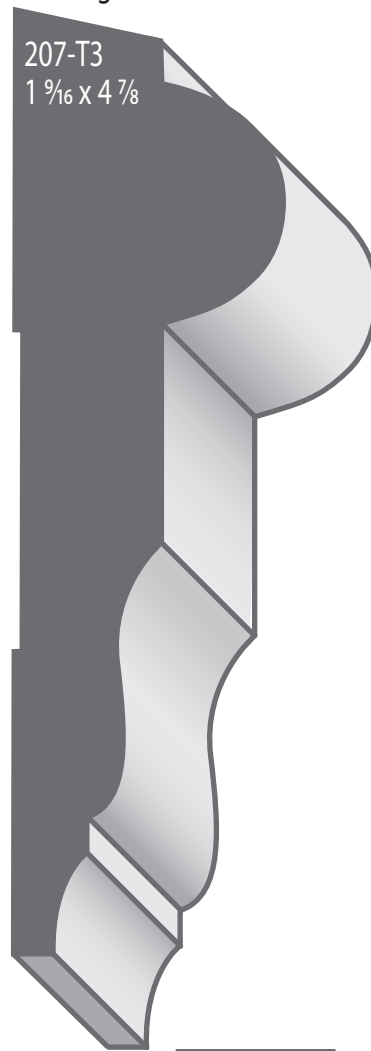
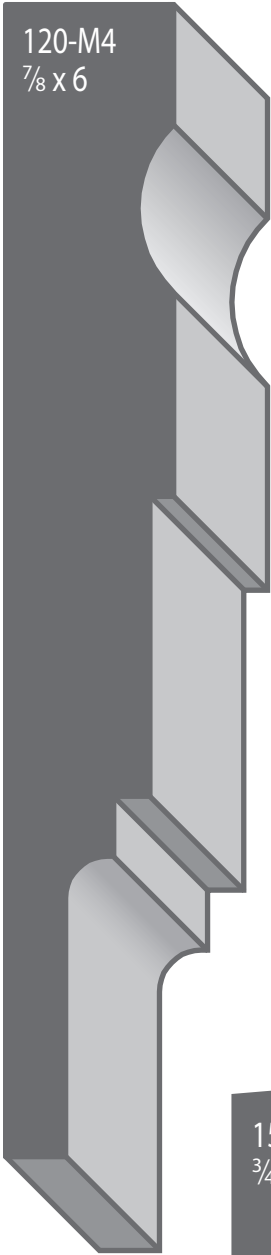

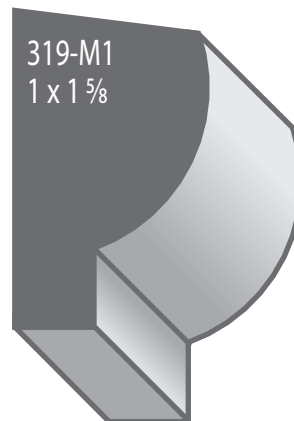

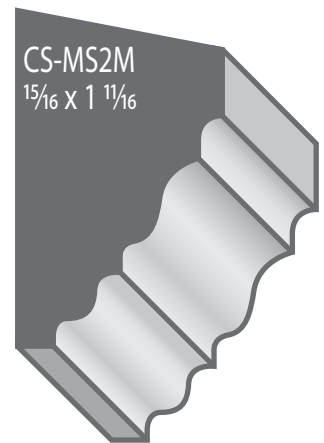
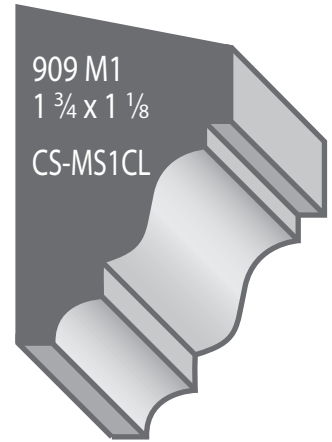
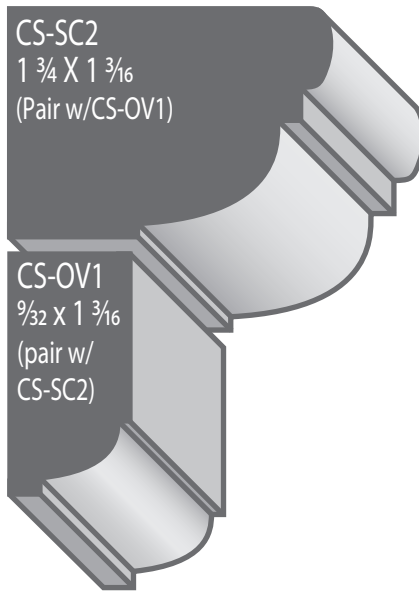
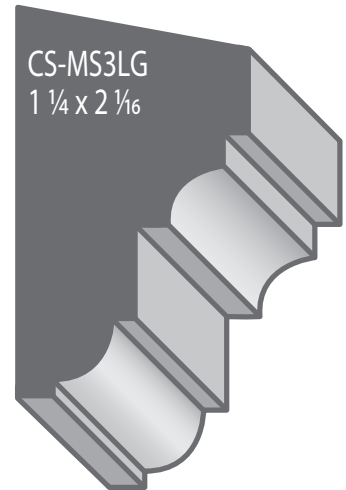
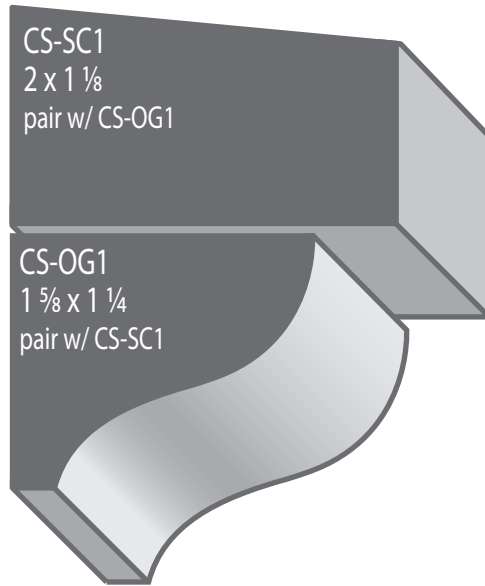
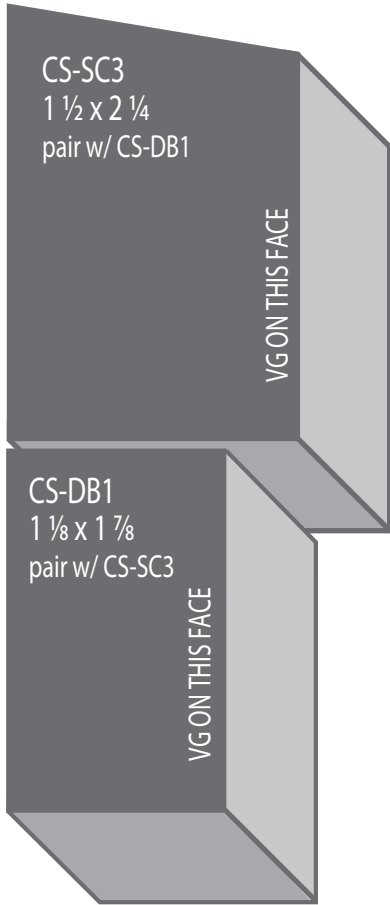

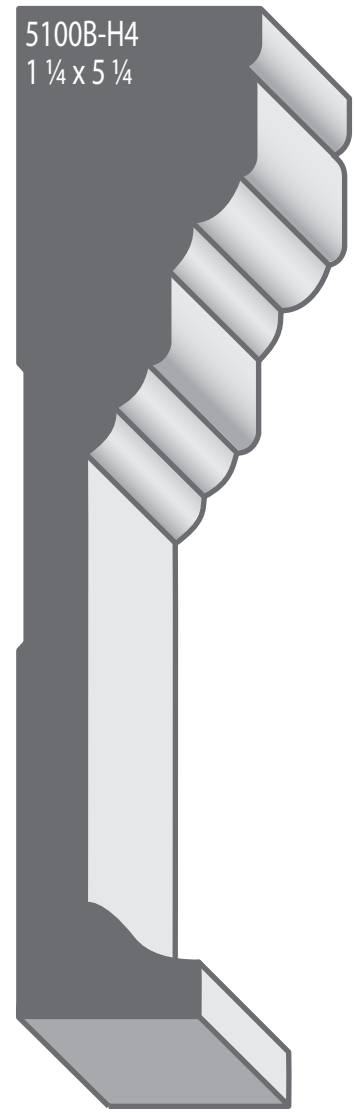
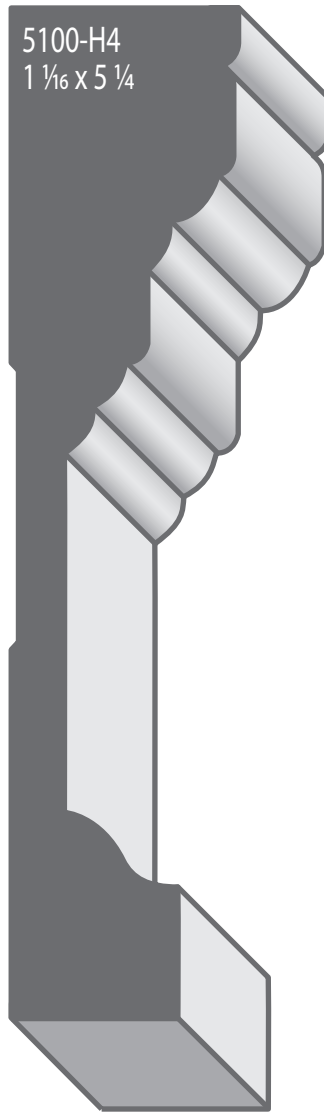
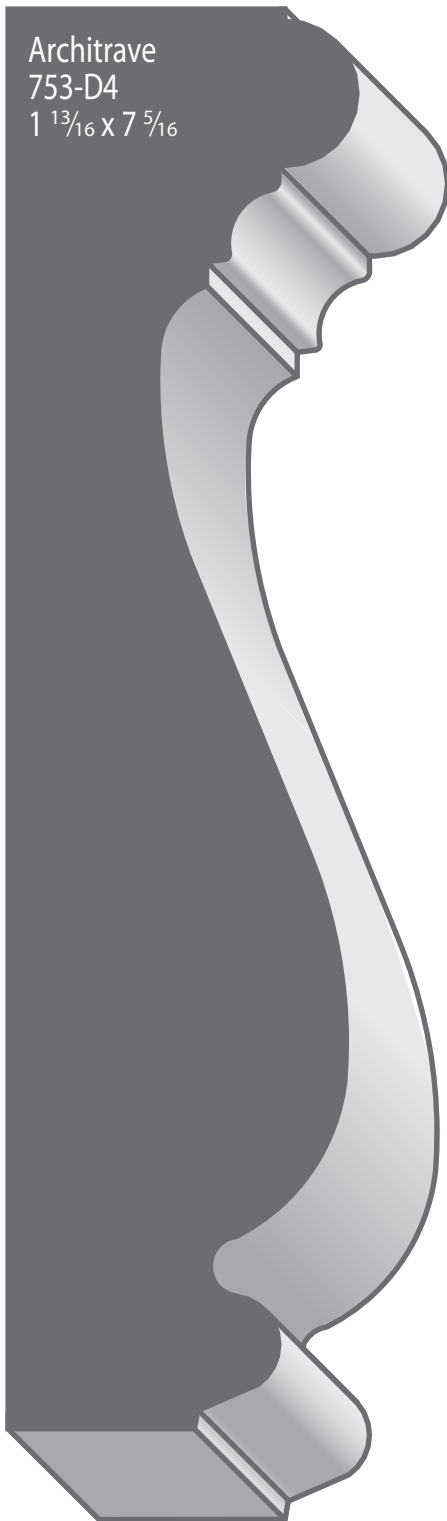



‡ Sample missing

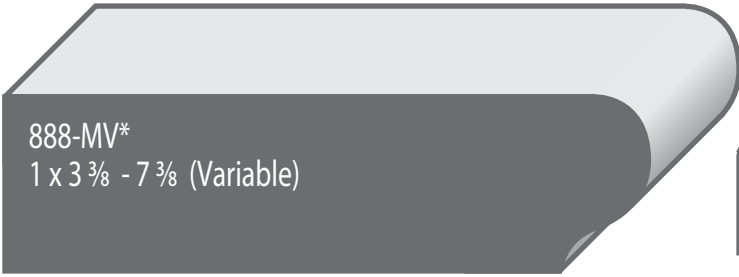

888-MV*
1 x 3 3/8 - 7 3/8 (Variable)

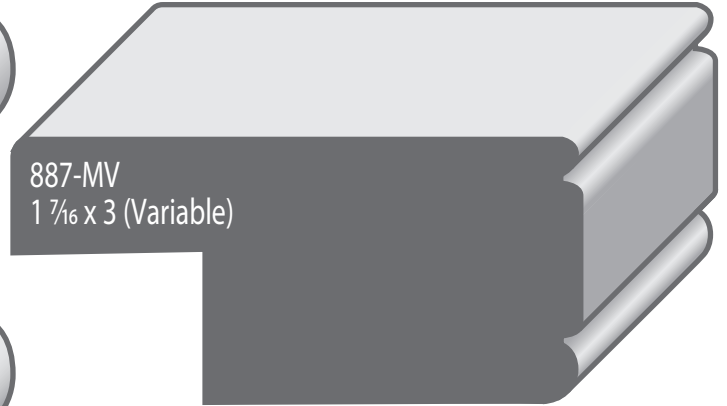

887-MV
1 7/16 x 3 (Variable)



889-MV
1 x 3 3/8 - 7 3/8 (Variable)

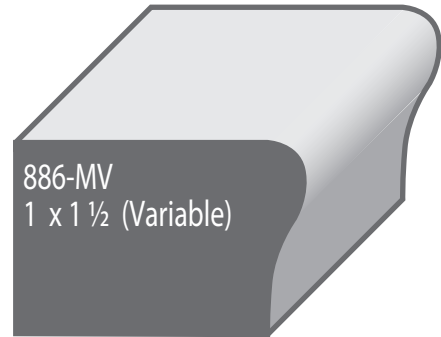

886-MV
1 x 1 1/2 (Variable)

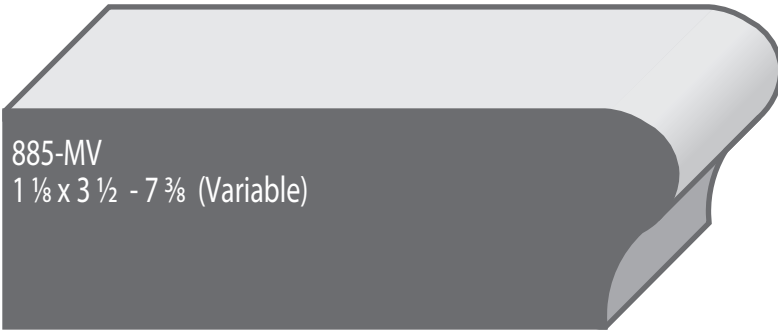

885-MV
1 1/8 x 3 1/2 - 7 3/8 (Variable)

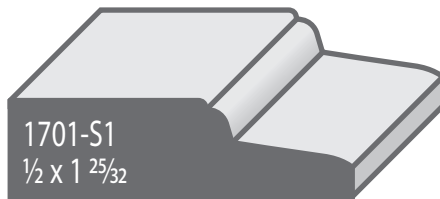

1701-S1
1/2 x 1 25/32

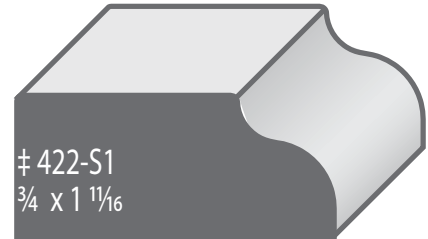

‡ 422-S1
3/4 x 1 11/16

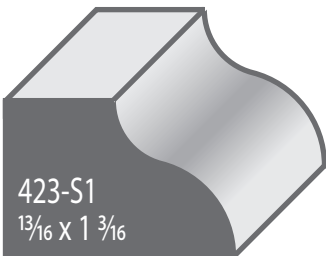

423-S1
13/16 x 1 3/16

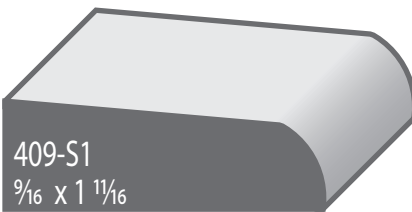

409-S1
9/16 x 1 11/16

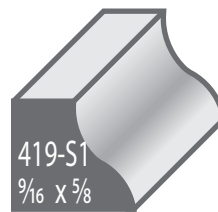

419-S1
9/16 x 5/8

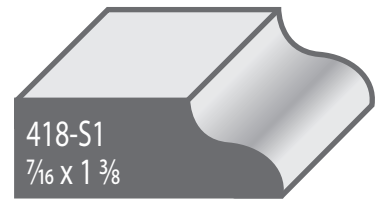

418-S1
7/16 x 1 3/8

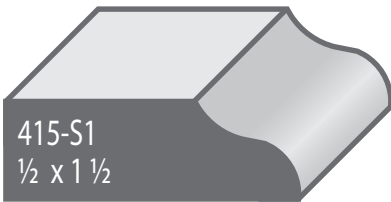

415-S1
1/2 x 1 1/2

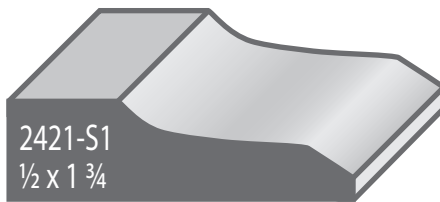

2421-S1
1/2 x 1 3/4



2420-SV
1/2 x Variable

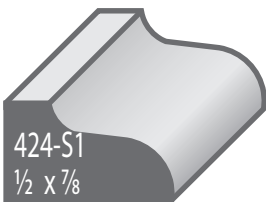

424-S1
1/2 x 7/8

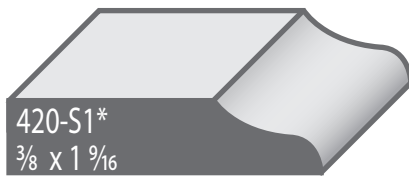

420-S1*
3/8 x 1 9/16

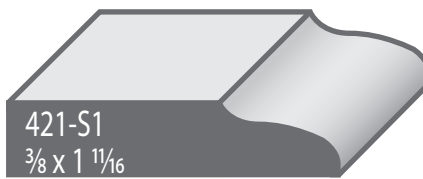

421-S1
3/8 x 1 11/16

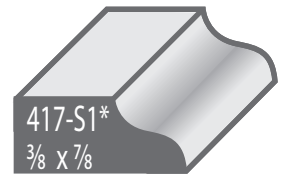

417-S1*
3/8 x 7/8

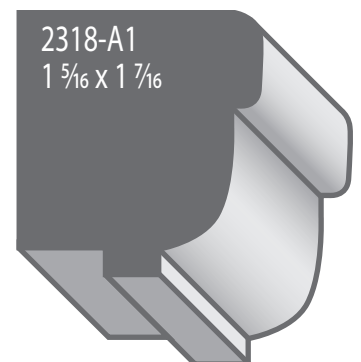
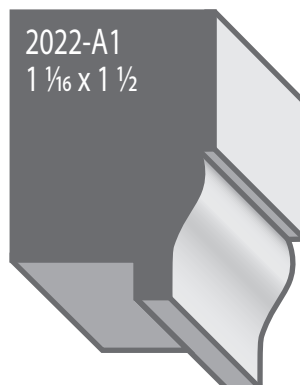
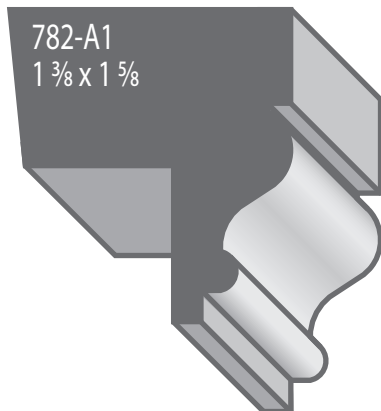
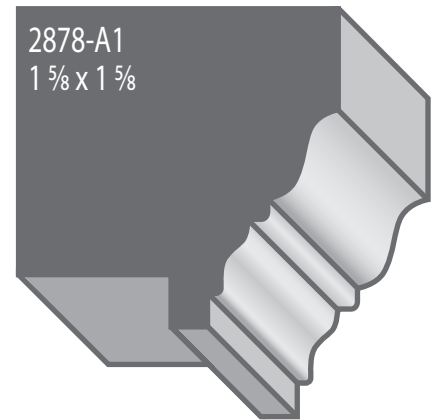
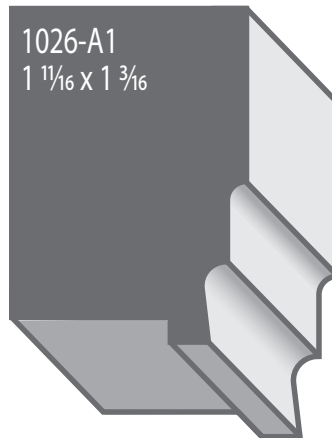
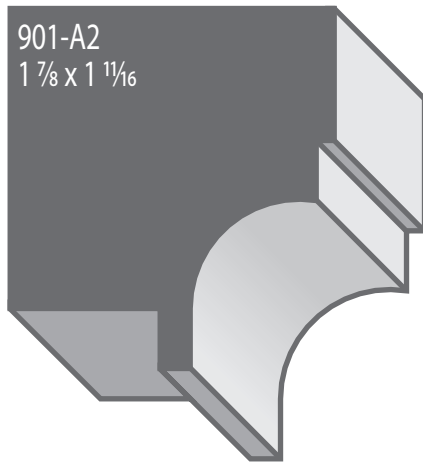
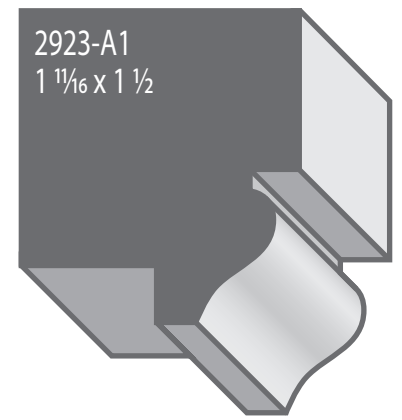
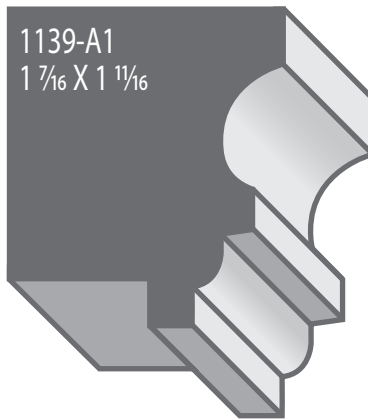
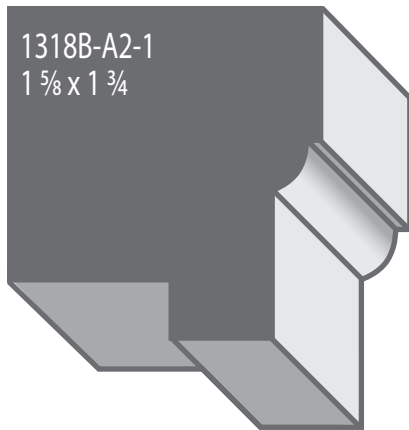
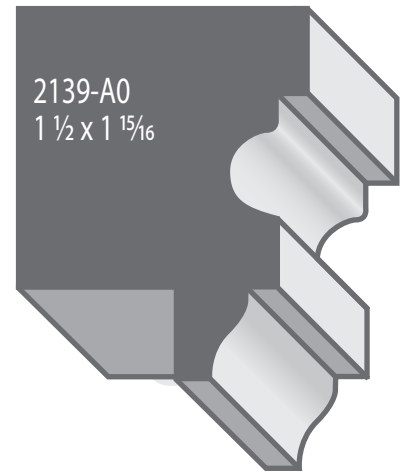
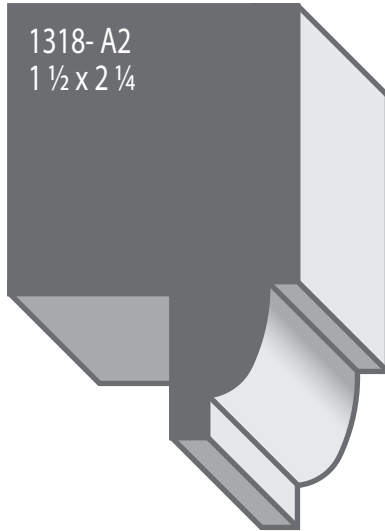
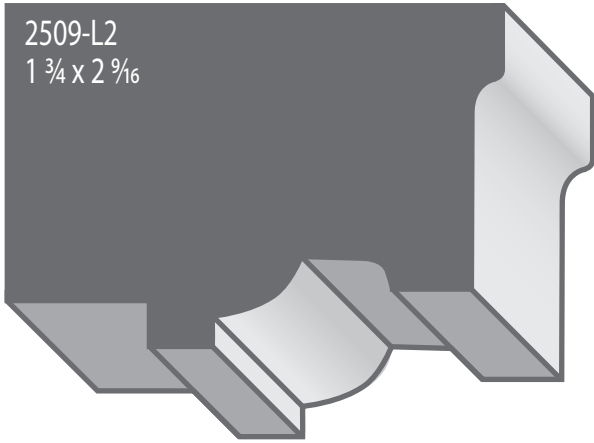

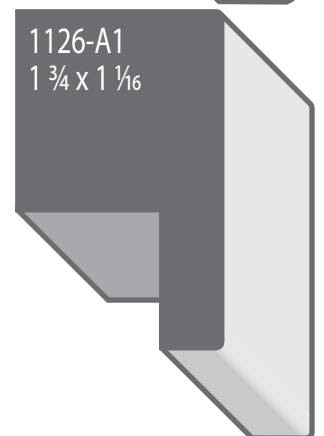
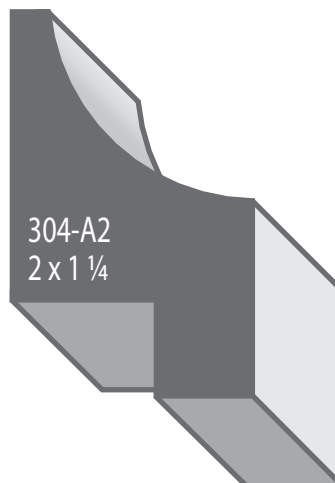
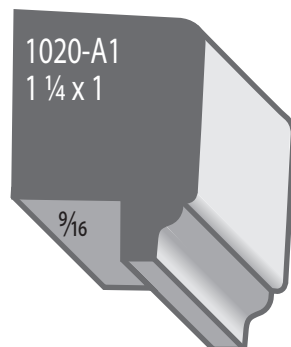
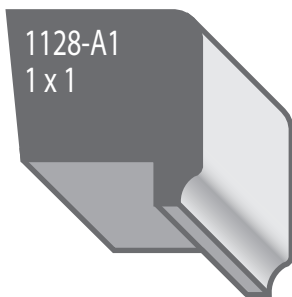
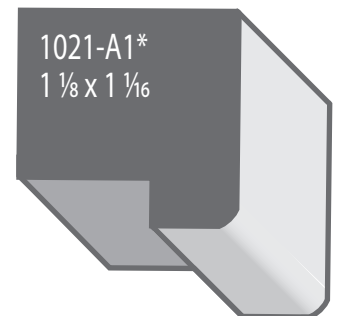
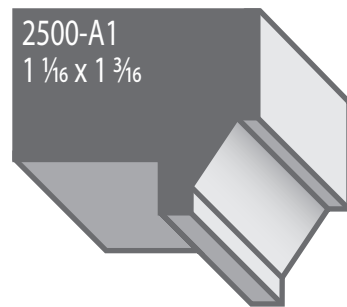
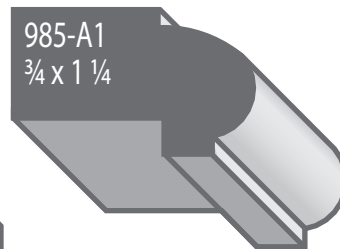
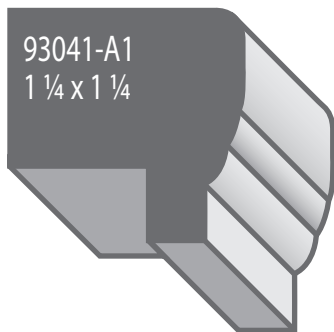
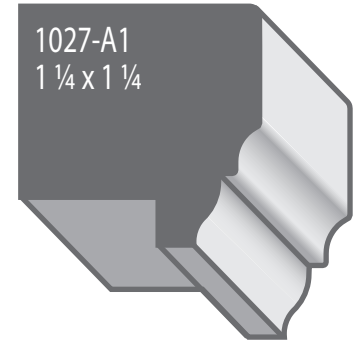
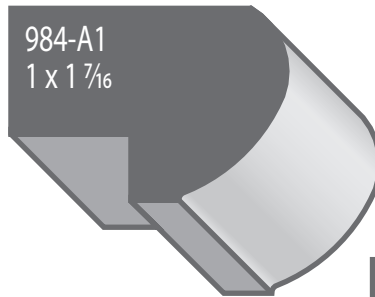
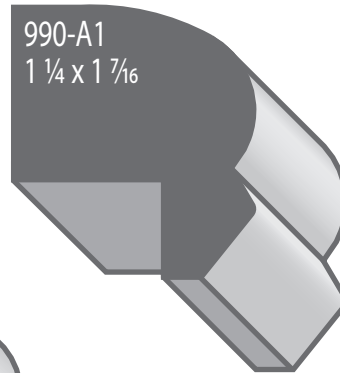
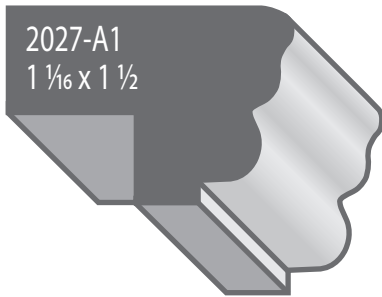
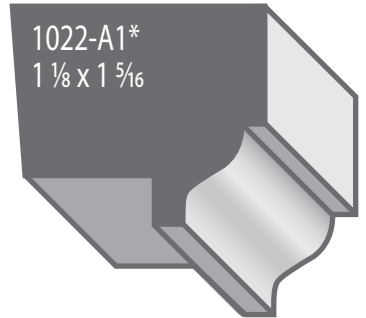
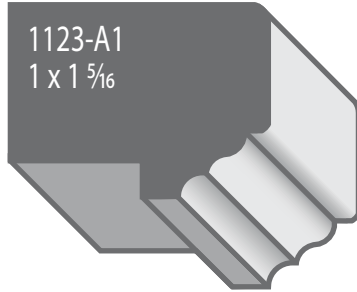
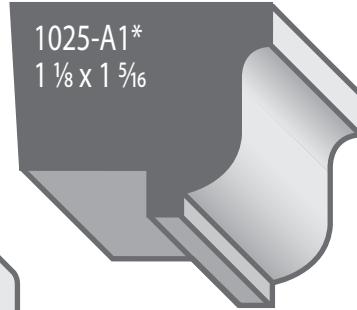
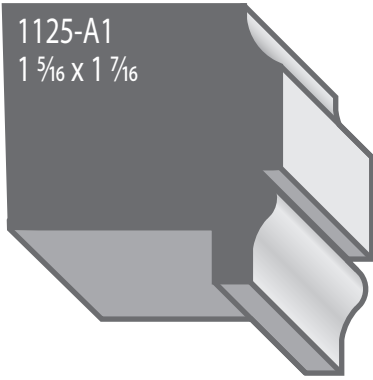



1922-A1
1 x 1 1/8

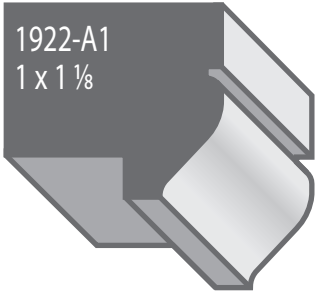

1127-A1
1 1/16 x 1 1/8

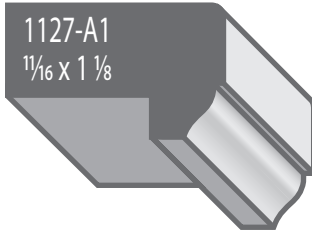

1024-A1
1 1/16 x 1 1/8

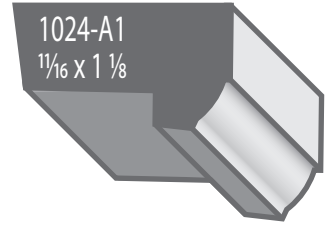

1129-P1
1 1/16 x 1 9/16

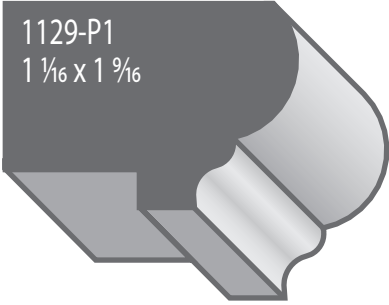

1029-A1*
1 1/8 x 1 7/8

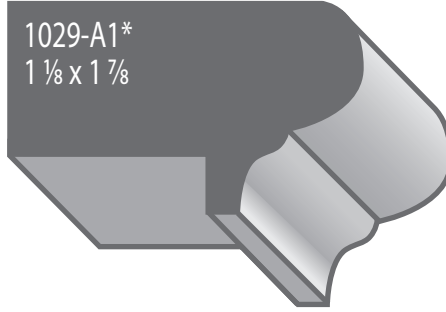

1028-P2
1 1/8 x 2 1/8

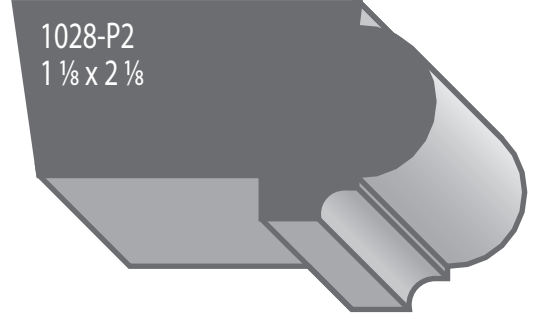

3029-A2
1 3/16 x 1 13/16

